









LEGENDE	
	Fibre Opérateur
	Ethernet Opérateur
	Fibre Utilisateur
	Ethernet Utilisateur
	Ethernet Redondance
	PC Serveur
	Switch
	Passerelle Ethernet TCP/IP
	Réseau de communication Bus ULP
	Afficheur en façade de tiroir
	Disjoncteur communicant
	Module Entrées / Sorties

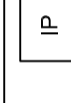

Centre Hospitalier Stell
1 rue Charles Drot
92500 Rueil Malmaison

Rénovation du poste électrique et création d'un TGS

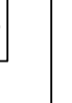
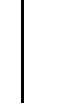
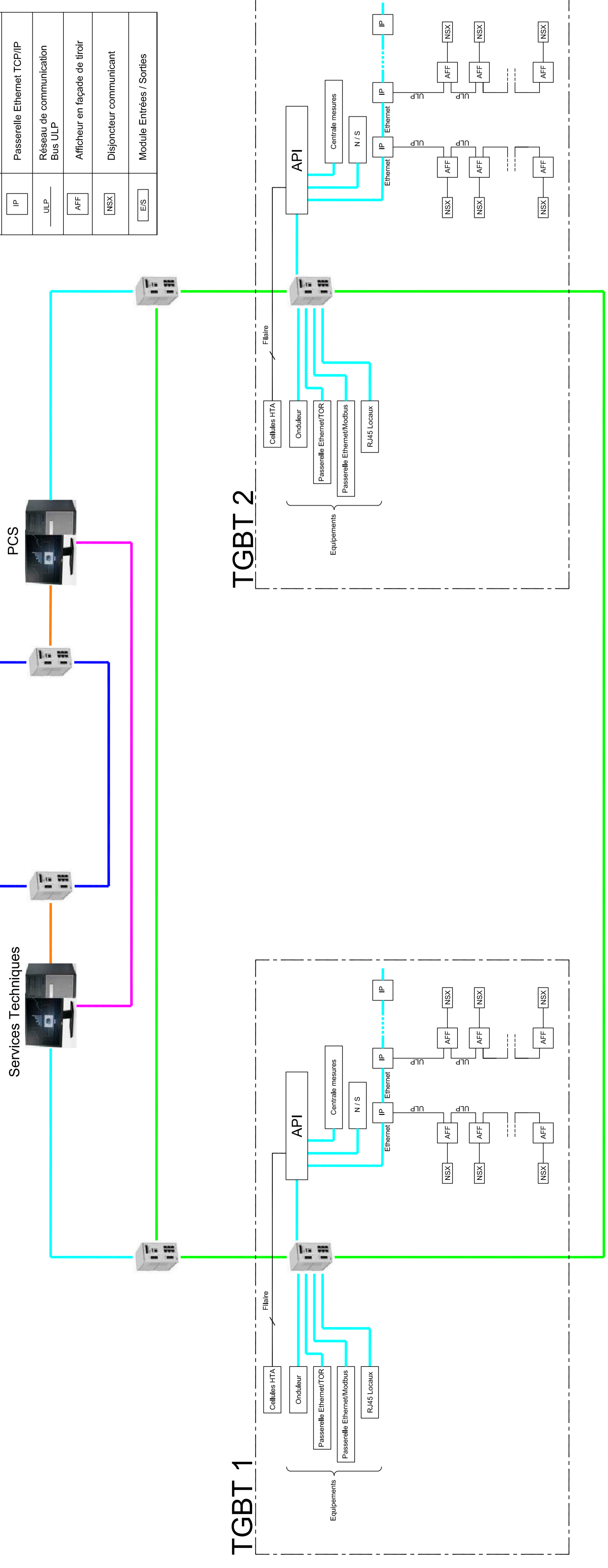
Ind	Date	Modifications

BUREAU D'ETUDES
TSE
6 rue Vitor
94148 ALFORTVILLE CEDEX
Tél: 01.41.79.35.60
Fax: 01.41.79.35.61
E-mail: E.TSE-IDF@wanadoo.fr

Date : Mars 2018
Echelle : sans
N° : **SY 18/04**

Phase
Synoptique de principe GTE
(Option)
DCE