

10/10/2017	0	C.C.	RETOUR ESSAIS	F.C.	E.A.
31/05/2017	B	F.C.	MISE A JOUR SUITE COMMENTAIRES CLIENT	F.CO.	E.A.
05/04/2017	A	F.C.	PREMIERE EMISSION	K.C.	E.A.
DATE DATE	REV. REV.	DESSINE PAR DRAWN BY	MODIFICATIONS REVISIONS	VERIFIE PAR CHECKED BY	APPROUVE PAR APPROVED BY

SCHEMA ELECTRIQUE ELECTRICAL DRAWING



3, Rue Pierre Curie
91230 MONTGERON
Tél. : 01.69.52.47.00 - Fax : 01.69.52.47.01
e-mail : seguin@automatismes-seguin.fr
<http://www.automatismes-seguin.fr>

PLAN: 170096

REV: 0

CDE: 17029970 YP 00900

Ce document est notre propriété. Il ne peut être reproduit et / ou communiqué sans autorisation.
This document is our property. It cannot be reproduced and / or transmitted without authorization.



Coffret Reprise QUINCY

LETTRE DE REPERAGE DES ELEMENTS DU SCHEMA

QI	INTERRUPTEUR	PCPI	CONTROLEUR D'ISOLEMENT	KT	RELAIS TEMPORISE	SA	COMMUTATEUR D'AMPEREMETRE
QIG	INTERRUPTEUR GENERAL	TR	TRANSFORMATEUR DE TENSION	KAU	RELAIS ARRET D'URGENCE	SV	COMMUTATEUR DE VOLTMETRE
QD	DISJONCTEUR	TC	TRANSFORMATEUR DE COURANT	UF	VARIATEUR	ECH	RESISTANCE CHAUFFANTE
QDG	DISJONCTEUR GENERAL	U	ONDULEUR, ALIMENTATION	UM	DEMARREUR	ECL	ECLAIRAGE
FP	PARAFODRE	KIC	INTER CREPUSCULAIRE	S	ORGANE DE COMMANDE	G	BATTERIE
FU	FUSIBLE	KIH	HORLOGE	H	VOYANT, SIRENE	P	INSTRUMENTATION
F	THERMIQUE	KTH	THERMOSTAT	PCH	COMPTEUR HORAIRE	X	PRISE DE COURANT, BORNIER
QF	SECTIONNEUR FUSIBLE	KM	CONTACTEUR	PA	AMPEREMETRE	E	MATERIELS AUTRES
PF	CONTROLEUR DE PHASE	KA	RELAIS	PV	VOLTMETRE	KTL	TELERUPTEUR

LETTER CODES FOR ITEMS DESIGNATION ON THE DRAWING

QI	SWITCH	PCPI	INSULATION CONTROLLER	KT	TEMPORIZES RELAY	SA	AMPEREMETER SWITCH
QIG	GENERAL SWITCH	TR	TENSION TRANSFORMER	KAU	EMERGENCY STOP RELAY	SV	VOLTMETER SWITCH
QD	BREAKER	TC	CURRENT TRANSFORMER	UF	VELOCITY VARIATOR	ECL	LIGHT
QDG	GENERAL BREAKER	U	INVERTER, SUPPLY	UM	MOTOR STARTER	ECH	HEATER
FP	LIGHTNING PROTECTOR	KIC	DIMMER	S	CONTROL UNIT	G	BATTERY
FU	FUSE	KIH	CLOCK	H	INDICATOR	P	INSTRUMENTATION
F	THERMAL RELAY	KTH	THERMOSTAT	PCH	TIMER	X	SOCKET, TERMINAL BLOCK
QF	DISCONNECTING SWITCH	KM	CONTACTOR	PA	AMPEREMETER	E	OTHER EQUIPMENTS
PF	PHASE CONTROLLER	KA	RELAY	PV	VOLTMETER	KTL	TELEBREAKER

COULEURS DE FILS

TRI 400V: <= 6 mm2 Noir Rouge Brun
> 6 mm2 Noir Bagué Noir Rouge Brun

NEUTRE: Bleu Clair

230VAC: Rouge avec Commun Bobines Blanc (*)

230VAC ONDULE: Neutre Bleu Clair Bagué Orange
Phase Noir Bagué Orange

110VAC: Noir avec Commun Bobines Blanc (*)

24VAC: Violet avec Commun Bobines Blanc (*)

24VDC: Bleu Foncé avec Commun Bobines Blanc (*)

48VAC: Violet avec Commun Bobines Blanc (*)

48VDC: Bleu Foncé avec Commun Bobines Blanc (*)

REPORTS: Orange

TERRE: Vert/Jaune

ANALOGIQUE: Une Paire + Brun - Blanc
Unifilaire Blanc

TENSION EXTERNE PERMANENTE INTER GENERAL OUVERT: Orange

ATTENTION

Si plusieurs tensions de télécommande, alors prendre uniquement le 230VAC avec Commun Bobines Blanc

(*) Si Télécommande

WIRE COLOR

TRI 400V: <= 6 mm2 Black Red Brown
> 6 mm2 Black with Ring Black Red Brown

NEUTRE: Light Blue

230VAC: Red with Spods Common White (*)

230VAC UPS: Neutre Light Blue with Ring Orange
Phase Black with Ring Orange

110VAC: Black with Spods Common White (*)

24VAC: Purple with Spods Common White (*)

24VDC: Dark Bleu with Spods Common White (*)

48VAC: Purple with Spods Common White (*)

48VDC: Dark Bleu with Spods Common White (*)

REPORTS: Orange

GROUND: Green/Yellow

ANALOGICAL: One Pair + Brown - White
Unifilar White

PERMANENTLY EXTERNAL POWER GENERAL BREAKER OPEN: Orange

CAUTION

If There are Several Tensions of Command Then to take Only the 230VAC with Spods Common White

(*) If Command

TYPE DE RELAIS ET DE CONTACT DANS LE SCHEMA

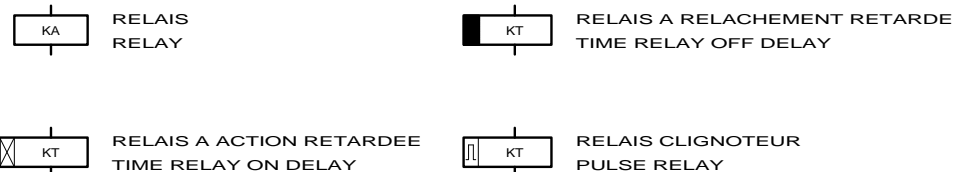

RELAY AND CONTACT TYPE IN THE DRAWING

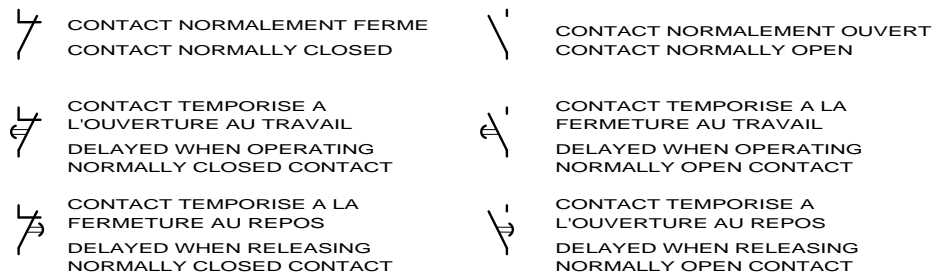

LE SCHEMA EST REPRESENTE HORS TENSION ET GENERATEUR HORS SERVICE

THE DRAWING IS SHOWN OUT OF VOLTAGE AND WITH GENERATOR OUT OF SERVICE



3, Rue Pierre Curie
91230 MONTGERON
Tél. : 01.69.52.47.00 - Fax : 01.69.52.47.01
e-mail : seguin@automatismes-seguin.fr
http://www.automatismes-seguin.fr

LEGENDE DU SCHEMA ELECTRIQUE

CLIENT ET NOM DU DOSSIER / CUSTOMER AND NAME OF FOLDER		INDICE / REVIEW
SAUR		0
Coffret Reprise QUINCY		IGE-XAO
DESSINATEUR / DRAWER	F.C.	FOLIO/SHEET 03/04
N° AFFAIRE / N° PROJECT	170096	VARZ

CODE DU REPERAGE

LETTER CODE

1/ DES APPAREILS DANS LES ARMOIRES
APPARATUS IN THE CABINETS



52 KA 01

N° D'ORDRE DANS LE FOLIO D'ORIGINE
ORDER NUMBER ON ORIGINAL SHEET

LETTRE DE REPERAGE
LETTER CODES FOR ITEM

N° DU FOLIO D'ORIGINE
ORIGINAL SHEET NUMBER

2/ DES FILS DE CABLAGE
WIRING

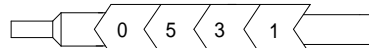

N° DU FOLIO D'ORIGINE
ORIGINAL SHEET NUMBER

N° DU FIL DANS LE FOLIO D'ORIGINE
NUMBER OF THE WIRE ON ORIGINAL SHEET

3/ REPORT DES CONTACTS DANS LE SCHEMA
CONTACT REPORT IN THE DRAWING



17.29

N° DE LA COLONNE OU EST UTILISE LE CONTACT
COLUMN NUMBER WHERE THE CONTACT IS USED

N° DU FOLIO OU EST UTILISE LE CONTACT
SHEET NUMBER WHERE THE CONTACT IS USED

4/ REPRESENTATION DES BORNES ET BORNIERES DANS LE SCHEMA
BINDINGS SCREWS VIEW IN THE DRAWING



N° D'ORDRE (SI NECESSAIRE)
ORDER NUMBER (IF NECESSARY)

NATURE DU BORNIER
NATURE OF TERMINAL BLOCK

A : ALIMENTATION
P : PUISSANCE
T : TELECOMMANDE
M : MESURE
R : REPORTS

BORNE SIMPLE
ORDINARY TERMINAL PIN

BORNE FUSIBLE
FUSE TERMINAL PIN

BORNE DE NEUTRE
NEUTRAL TERMINAL PIN

BORNE SECTIONNABLE
DISCONNECTING TERMINAL PIN

LE SCHEMA EST REPRESENTE HORS TENSION ET GENERATEUR HORS SERVICE

THE DRAWING IS SHOWN OUT OF VOLTAGE AND WITH GENERATOR OUT OF SERVICE



3, Rue Pierre Curie
91230 MONTGERON
Tél. : 01.69.52.47.00 - Fax : 01.69.52.47.01
e-mail : seguin@automatismes-seguin.fr
http://www.automatismes-seguin.fr

LEGENDE DU SCHEMA ELECTRIQUE

CLIENT ET NOM DU DOSSIER / CUSTOMER AND NAME OF FOLDER		INDICE / REVIEW
SAUR Coffret Reprise QUINCY		0
DESSINATEUR DRAWER	F.C.	IGE-XAO
N° AFFAIRE N° PROJECT	170096	
FOLIO/SHEET 04/05		V4R2

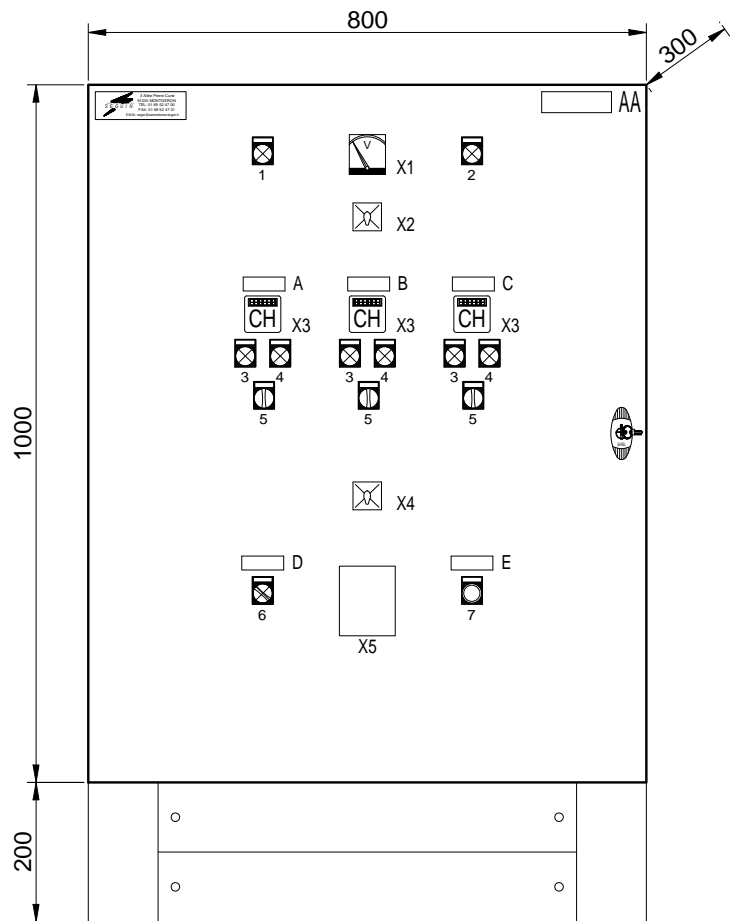

ETIQUETTES 100x30

AA - REPRISE QUINCY

ETIQUETTES 60x20

- A - POMPE 1 REPRISE
- B - POMPE 2 REPRISE
- C - POMPE 3 REPRISE
- D - MODE INTERVENTION
- E - ACQUITTEMENT

ETIQUETTES SCHNEIDER

- 1 - SOUS TENSION
- 2 - MANQUE D'EAU
- 3 - MARCHE
- 4 - DEFAUT
- 5 - AUTO / 0 / MAIN
- 6 - 0 / 1
- 7 - DEFAUTS

DIVERS

- X1 - VOLTMETRE
- X2 - COMMUTATEUR VOLTMETRE
- X3 - COMPTEUR HORAIRE
- X4 - CHOIX DE PROGRAMMES
- X5 - CLAVIER



3, Rue Pierre Curie
91230 MONTGERON
Tél. : 01.69.52.47.00 - Fax : 01.69.52.47.01
e-mail : seguin@automatismes-seguin.fr
http://www.automatismes-seguin.fr

IMPLANTATION EXTERNE

CLIENT ET NOM DU DOSSIER / CUSTOMER AND NAME OF FOLDER		INDICE / REVIEW
SAUR Coffret Reprise QUINCY		0
DESSINATEUR DRAWER	F.C.	IGE-XAO
N° AFFAIRE N° PROJECT	170096	
FOLIO/SHEET		05 / 10
		VAR2

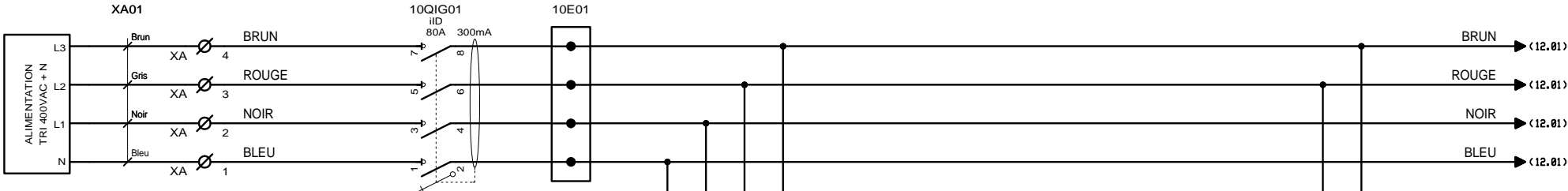

TARIF :
 ICC :
 REGIME DE NEUTRE :
 COMPTAGE :

A CONFIRMER

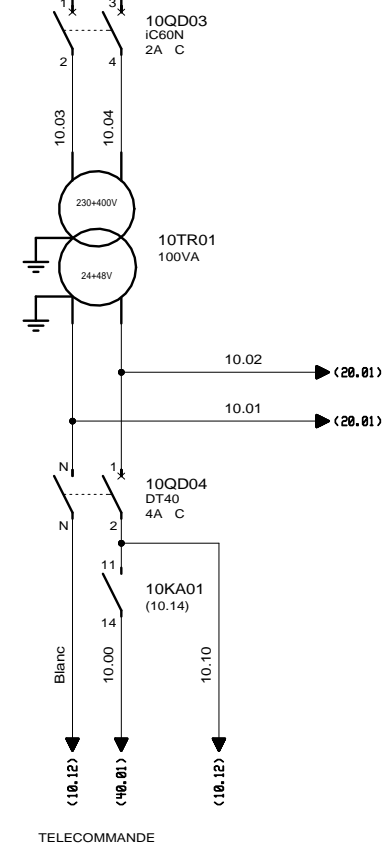
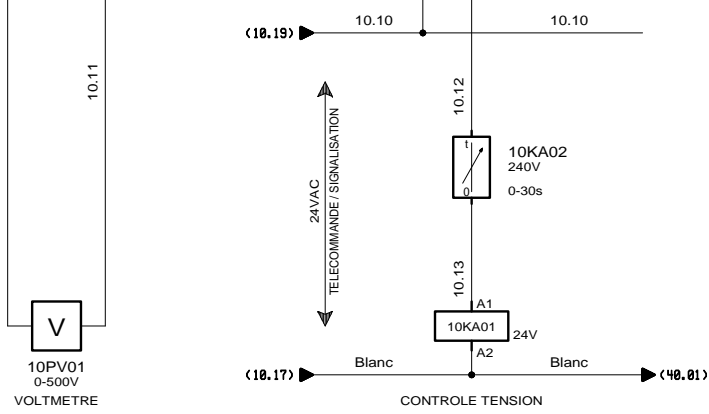
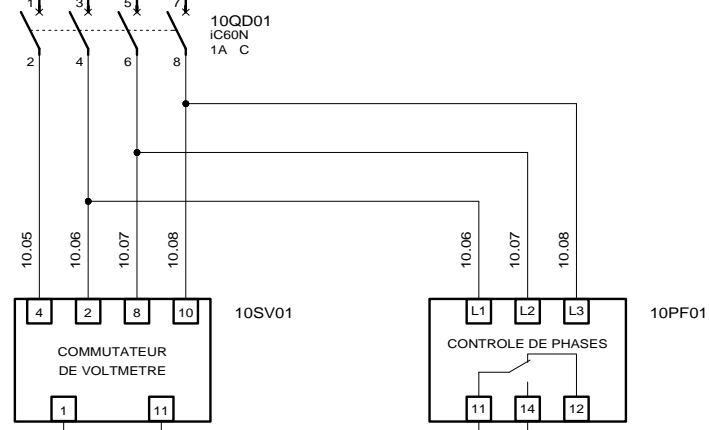

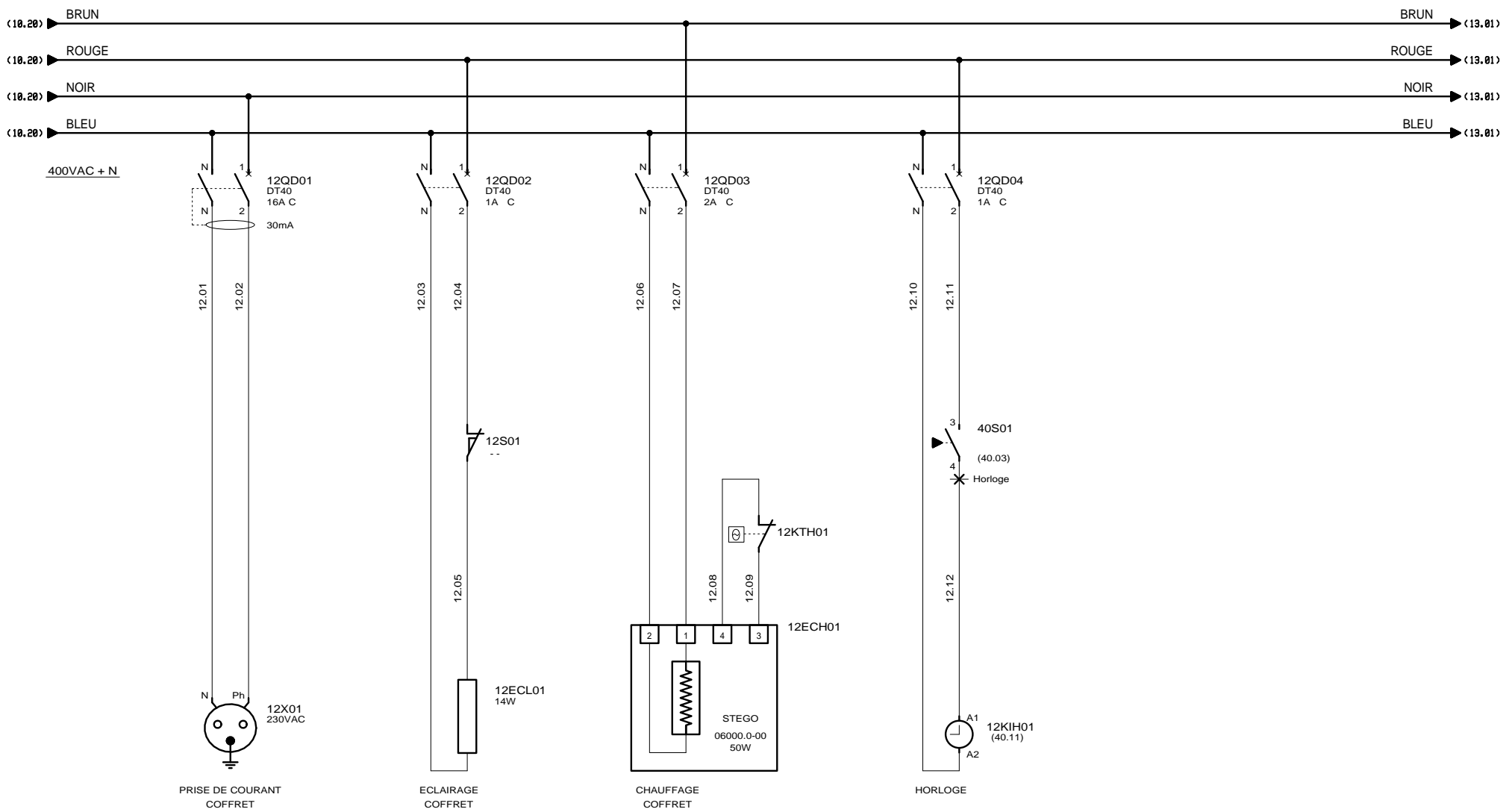

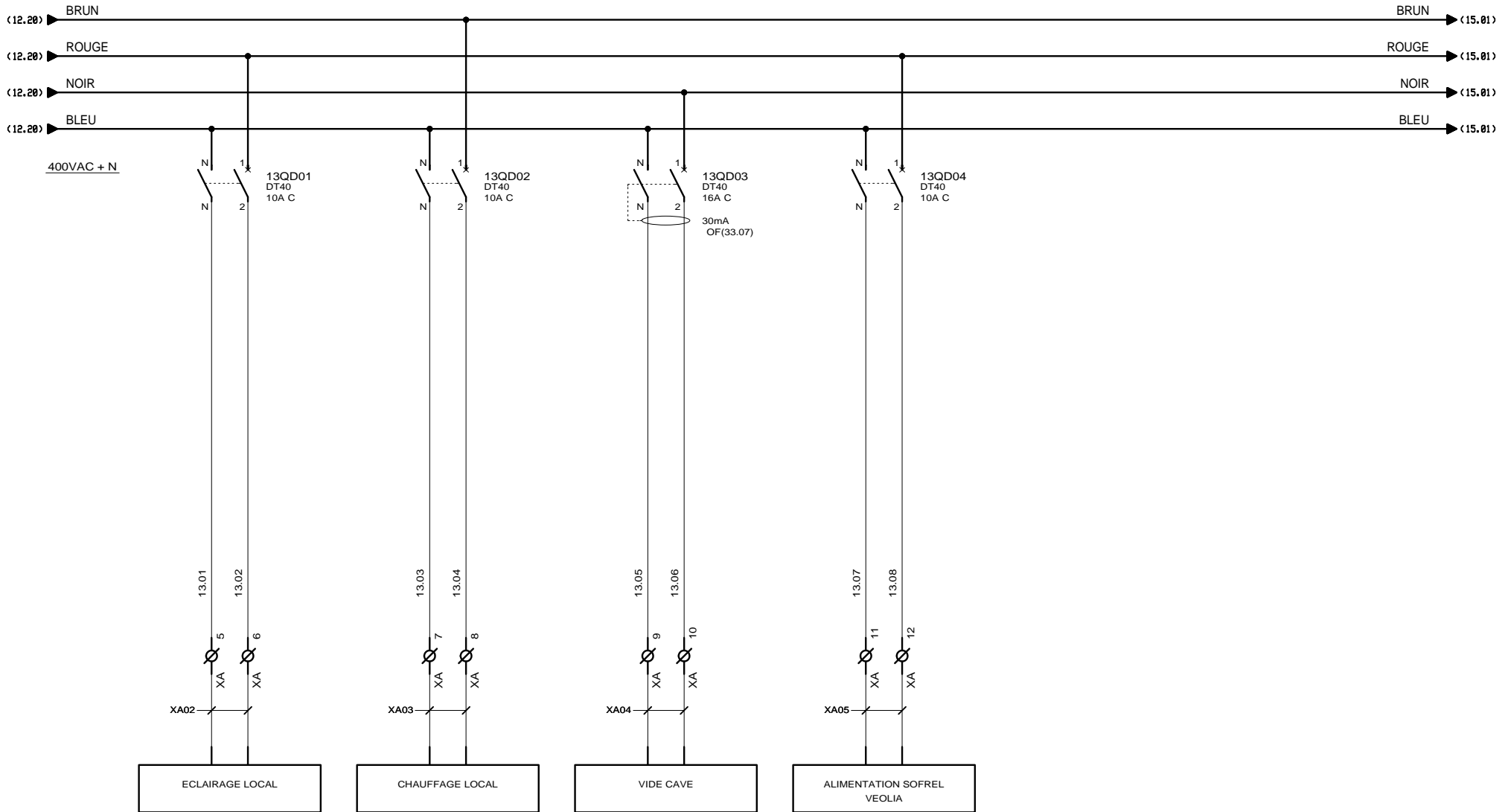



 3, Rue Pierre Curie
 91230 MONTGERON
 Tél. : 01.69.52.47.00 - Fax : 01.69.52.47.01
 e-mail : seguin@automatismes-seguin.fr
 http://www.automatismes-seguin.fr

DISTRIBUTION 400VAC

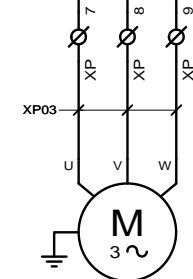
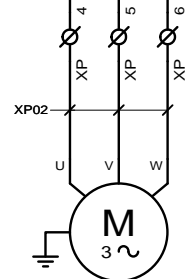
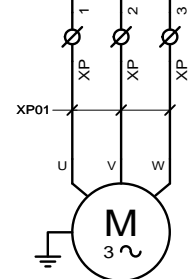
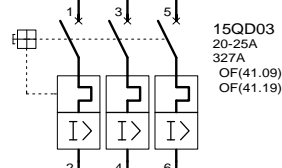
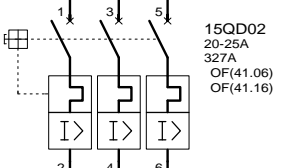
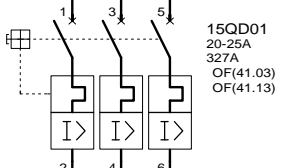
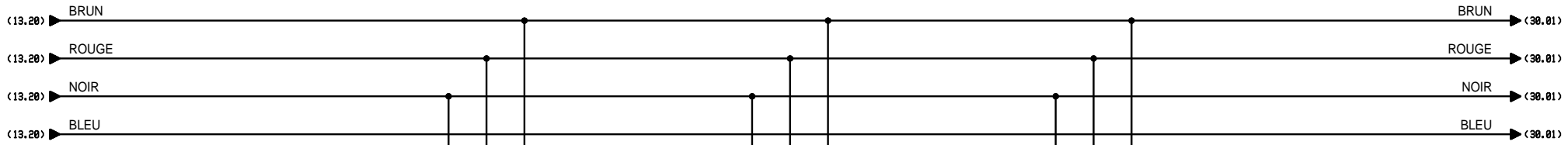
CLIENT ET NOM DU DOSSIER / CUSTOMER AND NAME OF FOLDER		INDICE / REVIEW
SAUR Coffret Reprise QUINCY		0
DESSINATEUR DRAWER	F.C.	 FOLIO/SHEET 13 / 15 VARZ
N° AFFAIRE N° PROJECT	170096	



POMPE 1 REPRISE	
Pmax	12.1 KW
In	22 A

POMPE 2 REPRISE	
Pmax	12.1 KW
In	22 A

POMPE 3 REPRISE	
Pmax	12.1 KW
In	22 A



3, Rue Pierre Curie
91230 MONTGERON
Tél. : 01.69.52.47.00 - Fax : 01.69.52.47.01
e-mail : seguin@automatismes-seguin.fr
http://www.automatismes-seguin.fr

PUISSANCE POMPES REPRISES

CLIENT ET NOM DU DOSSIER / CUSTOMER AND NAME OF FOLDER		INDICE / REVIEW
SAUR Coffret Reprise QUINCY		0
DESSINATEUR DRAWER	F.C.	FOLIO/SHEET 15 / 20
N° AFFAIRE N° PROJECT	170096	
		V4R2

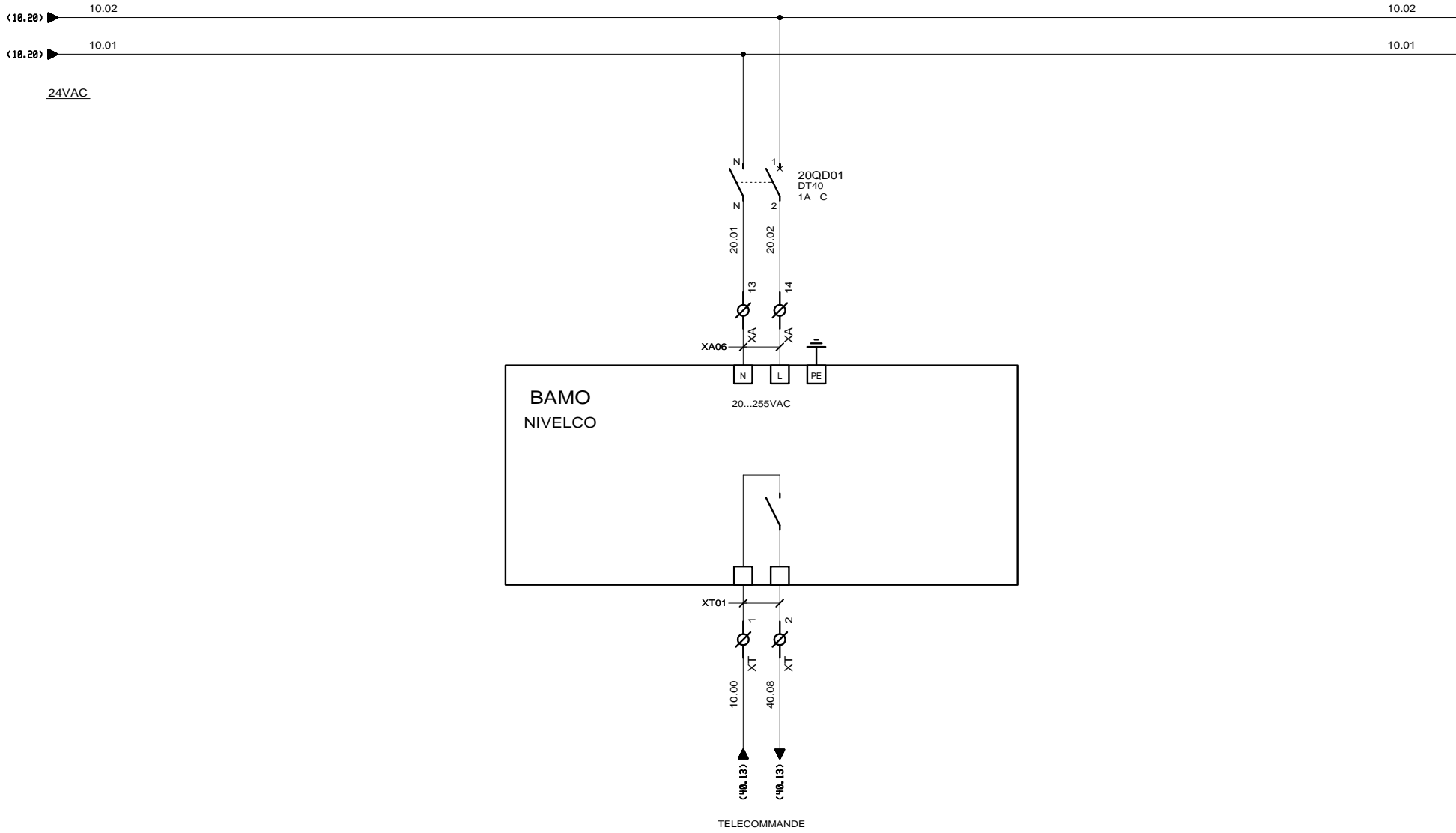

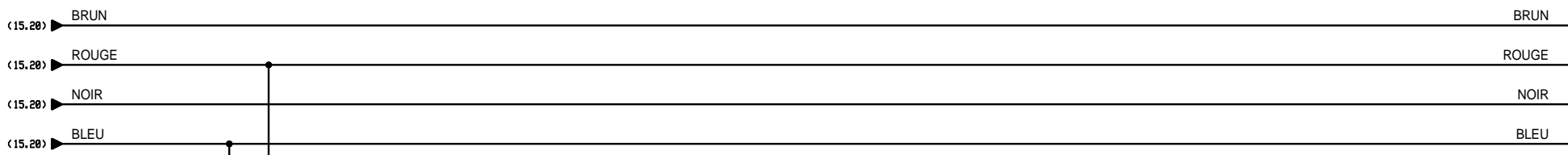

SOFREL S550 (VUE DE DESSOUS)

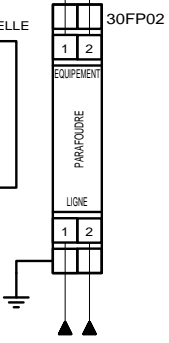
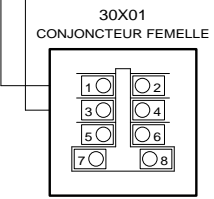
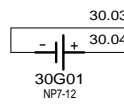
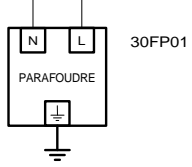
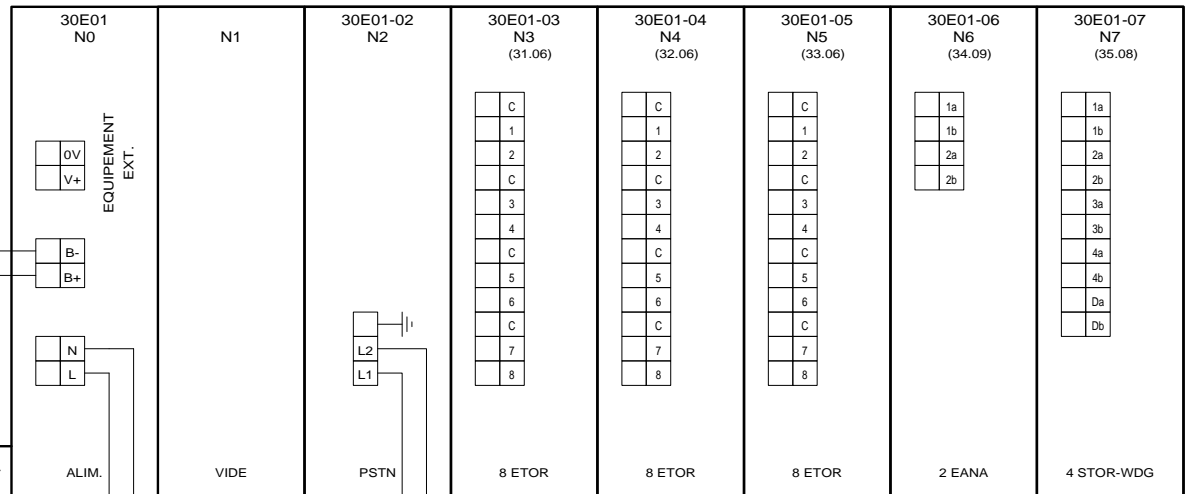

LIGNE RTC (DIRECTE)

ALIMENTATION SOFREL S550

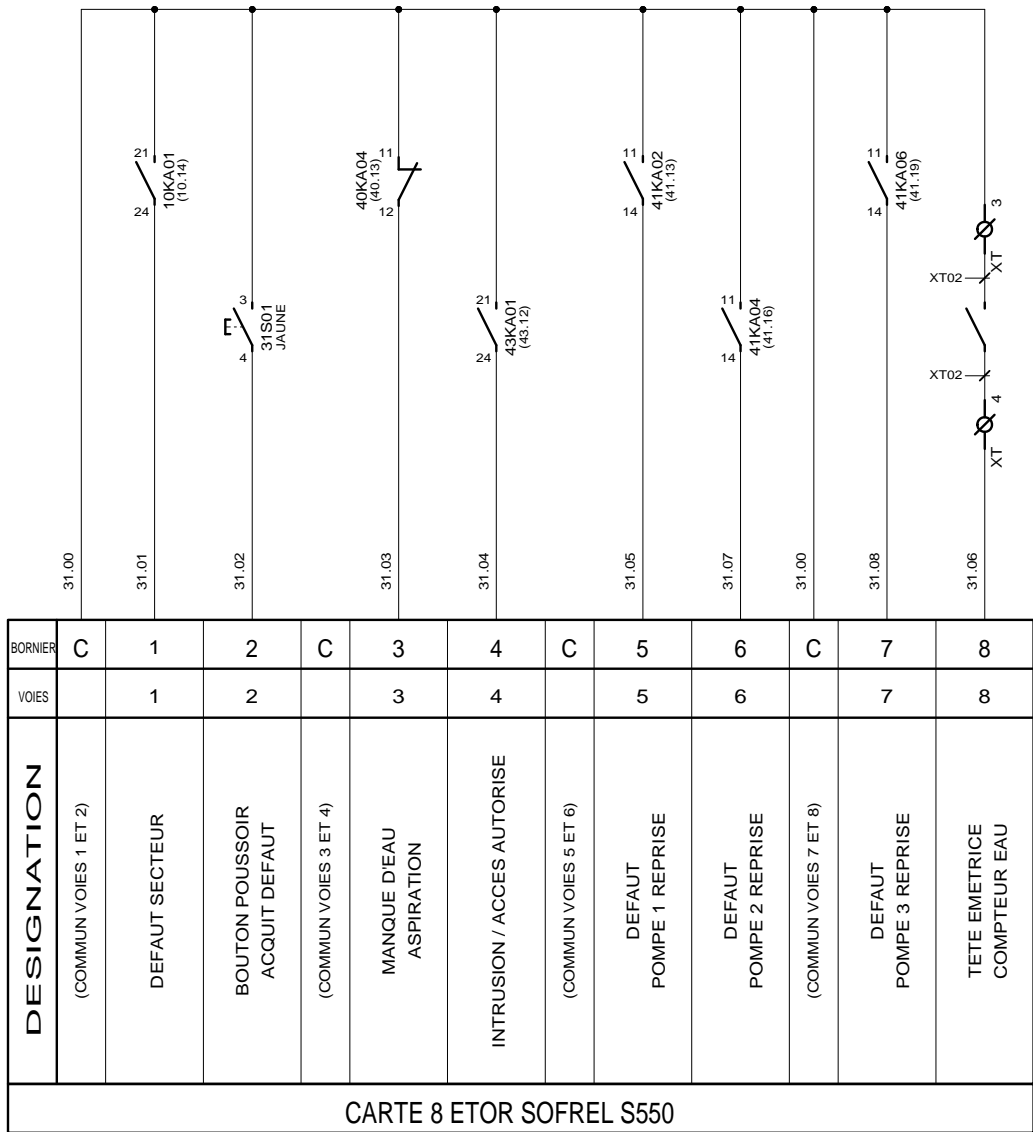

30E01-03
(30.10)

**CARTE 8 ENTRES TOR
EMPLACEMENT 3**

CLIENT ET NOM DU DOSSIER / CUSTOMER AND NAME OF FOLDER		INDICE / REVIEW
SAUR Coffret Reprise QUINCY		0
DESSINATEUR DRAWER	F.C.	IGE-XAO
N° AFFAIRE N° PROJECT	170096	
FOLIO/SHEET		31 / 32
		VARZ

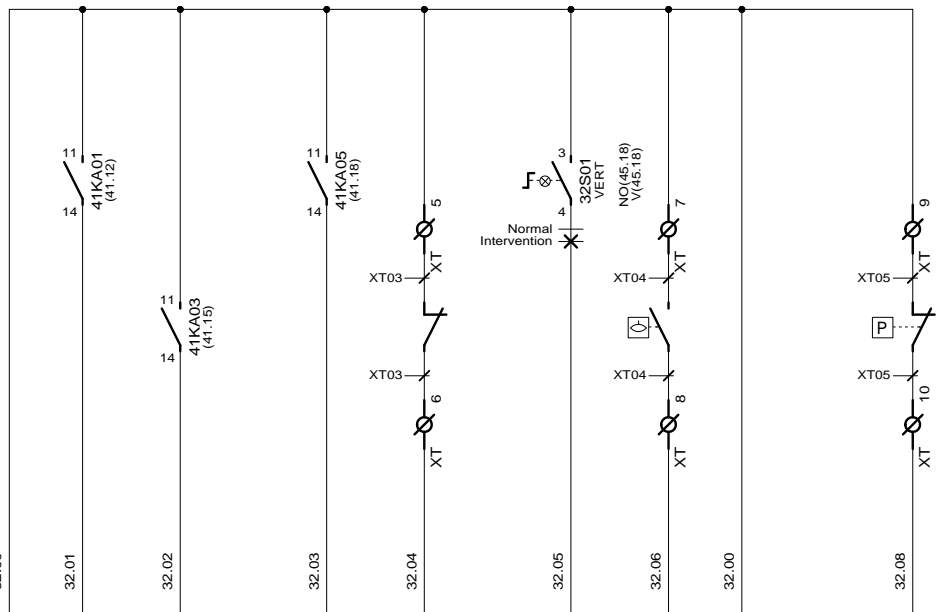

BORNIER	C	1	2	C	3	4	C	5	6	C	7	8
VOIES		1	2		3	4		5	6		7	8
DESIGNATION	(COMMUN VOIES 1 ET 2)	RETOUR DE MARCHÉ POMPE 1 REPRISE	RETOUR DE MARCHÉ POMPE 2 REPRISE	(COMMUN VOIES 3 ET 4)	RETOUR DE MARCHÉ POMPE 3 REPRISE	CONTACT INTRUSION	(COMMUN VOIES 5 ET 6)	COMMUTATEUR EN MODE INTERVENTION	INONDATION LOCAL	(COMMUN VOIES 7 ET 8)		PRESSION HAUTE REFOULEMENT REPRISE
CARTE 8 ETOR SOFREL S550												

30E01-04
(30.11)



3, Rue Pierre Curie
91230 MONTGERON
Tél. : 01.69.52.47.00 - Fax : 01.69.52.47.01
e-mail : seguin@automatismes-seguin.fr
http://www.automatismes-seguin.fr

CARTE 8 ENTRES TOR EMPLACEMENT 4

CLIENT ET NOM DU DOSSIER / CUSTOMER AND NAME OF FOLDER		INDICE / REVIEW
SAUR Coffret Reprise QUINCY		0
DESSINATEUR DRAWER	F.C.	IGE-XAO
N° AFFAIRE N° PROJECT	170096	
FOLIO/SHEET 32 / 33		VARZ

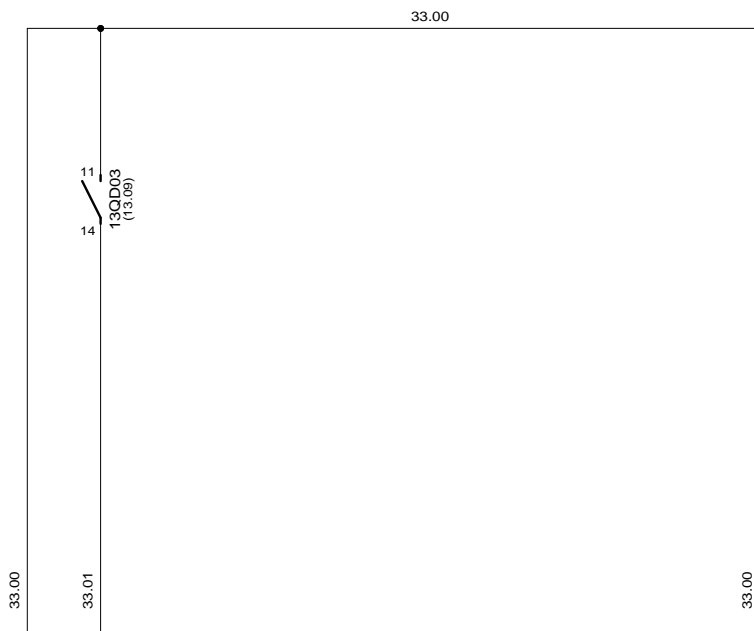

BORNIER	C	1	2	C	3	4	C	5	6	C	7	8
VOIES		1	2		3	4		5	6		7	8
DESIGNATION	(COMMUN VOIES 1 ET 2)	DEFAULT VIDE CAVE		(COMMUN VOIES 3 ET 4)			(COMMUN VOIES 5 ET 6)			(COMMUN VOIES 7 ET 8)		
CARTE 8 ETOR SOFREL S550												

30E01-05
(30.13)



3, Rue Pierre Curie
91230 MONTGERON
Tél. : 01.69.52.47.00 - Fax : 01.69.52.47.01
e-mail : seguin@automatismes-seguin.fr
http://www.automatismes-seguin.fr

CARTE 8 ENTREES TOR EMPLACEMENT 5

CLIENT ET NOM DU DOSSIER / CUSTOMER AND NAME OF FOLDER		INDICE / REVIEW
SAUR Coffret Reprise QUINCY		0
DESSINATEUR DRAWER	F.C.	FOLIO/SHEET 33 / 34
N° AFFAIRE N° PROJECT	170096	
		V4R2

RACCORDEMENT :
POUR CAPTEUR AUTONOME

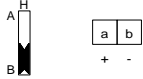

RACCORDEMENT :
POUR CAPTEUR TELEALIMENTE

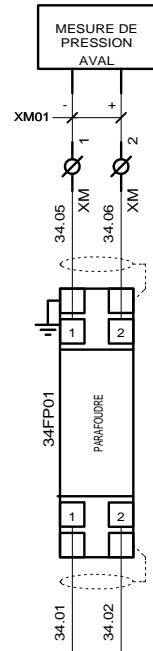
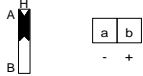

30E01-06
(30.14)

BORNIER	1a	1b	2a	2b	3a	3b	4a	4b
VOIES	1		2		3		4	
DESIGNATION	MESURE DE PRESSION AVAL REPRISE							
CARTE 4 EANA SOFREL S550								



3, Rue Pierre Curie
91230 MONTGERON
Tél. : 01.69.52.47.00 - Fax : 01.69.52.47.01
e-mail : seguin@automatismes-seguin.fr
http://www.automatismes-seguin.fr

CARTE 4 ENTREES ANALOGIQUES EMPLACEMENT 6

CLIENT ET NOM DU DOSSIER / CUSTOMER AND NAME OF FOLDER			INDICE / REVIEW
SAUR Coffret Reprise QUINCY			0
DESSINATEUR DRAWER	F.C.	FOLIO/SHEET	34 / 35
N° AFFAIRE N° PROJECT	170096		V4R2

CARTE 4 STOR-wdg SOFREL S550										
DESIGNATION	COMMANDE POMPES REPRISSES				COMMANDE SIRENE		COMMANDE FEU CLIGNOTANT ET BUZZER		CHIEN DE GARDE	
	VOIES	1		2		3		4		5
BORNIER	1a	1b	2a	2b	3a	3b	4a	4b	Da	Db

30E01-07
(30.16)

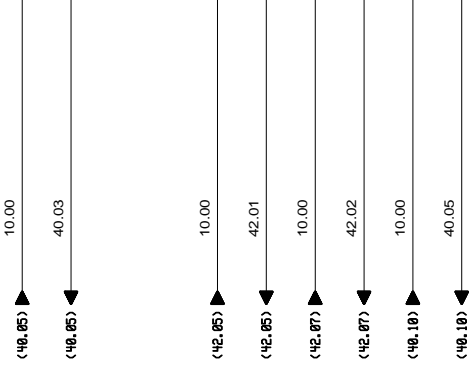

3, Rue Pierre Curie
91230 MONTGERON
Tél. : 01.69.52.47.00 - Fax : 01.69.52.47.01
e-mail : seguin@automatismes-seguin.fr
http://www.automatismes-seguin.fr

**CARTE 4 SORTIES TOR
EMPLACEMENT 7**

CLIENT ET NOM DU DOSSIER / CUSTOMER AND NAME OF FOLDER			INDICE / REVIEW
SAUR Coffret Reprise QUINCY			0
DESSINATEUR DRAWER	F.C.	FOLIO/SHEET	35 / 40
N° AFFAIRE N° PROJECT	170096		IGE-XAO VARZ

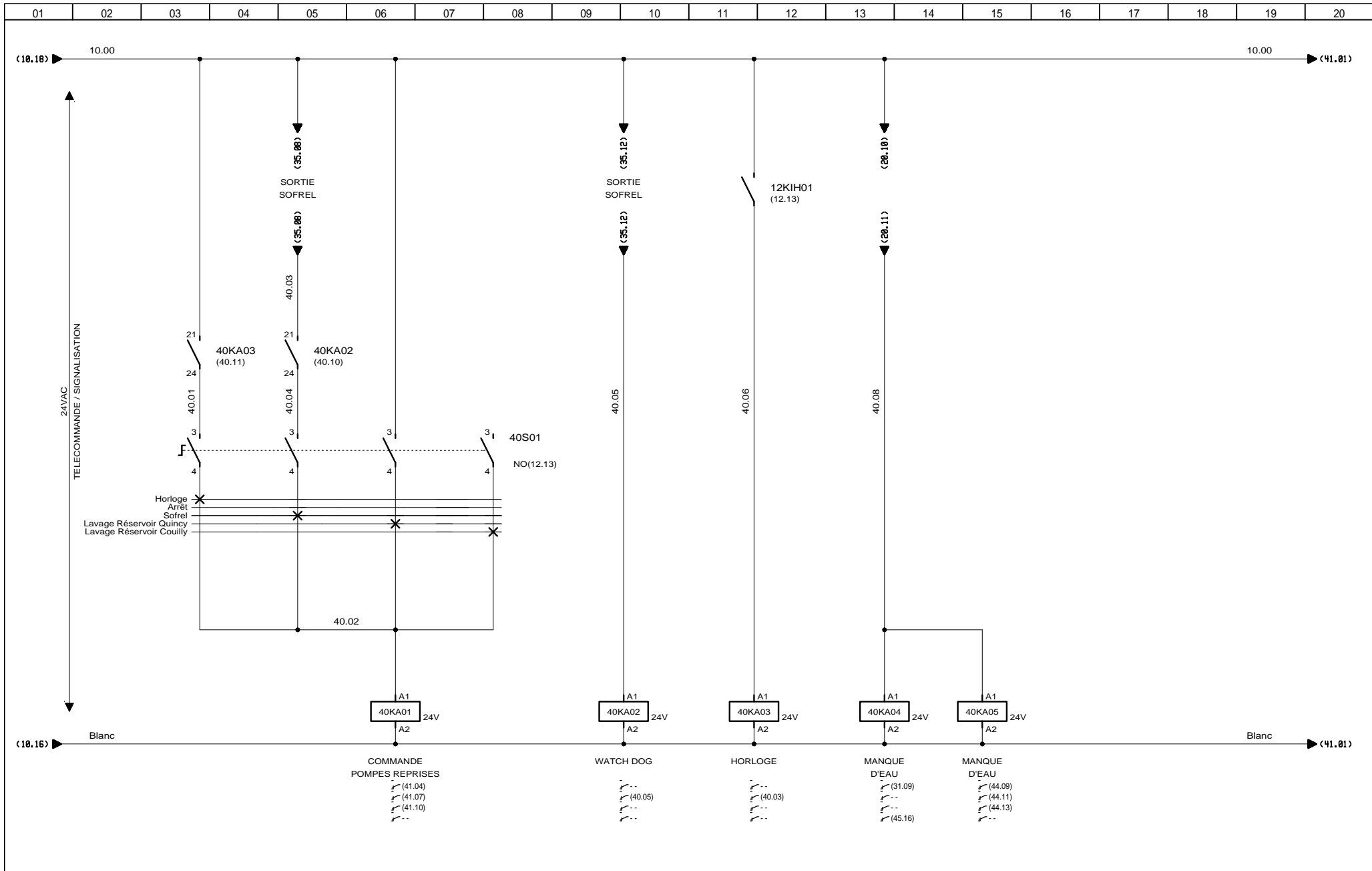

3, Rue Pierre Curie
91230 MONTGERON
Tél. : 01.69.52.47.00 - Fax : 01.69.52.47.01
e-mail : seguin@automatismes-seguin.fr
http://www.automatismes-seguin.fr

TELECOMMANDE

CLIENT ET NOM DU DOSSIER / CUSTOMER AND NAME OF FOLDER		INDICE / REVIEW
SAUR Coffret Reprise QUINCY		O
DESSINATEUR DRAWER	F.C.	IGE XAO
N° AFFAIRE N° PROJECT	170096	
FOLIO/SHEET 40 / 41		V4R2

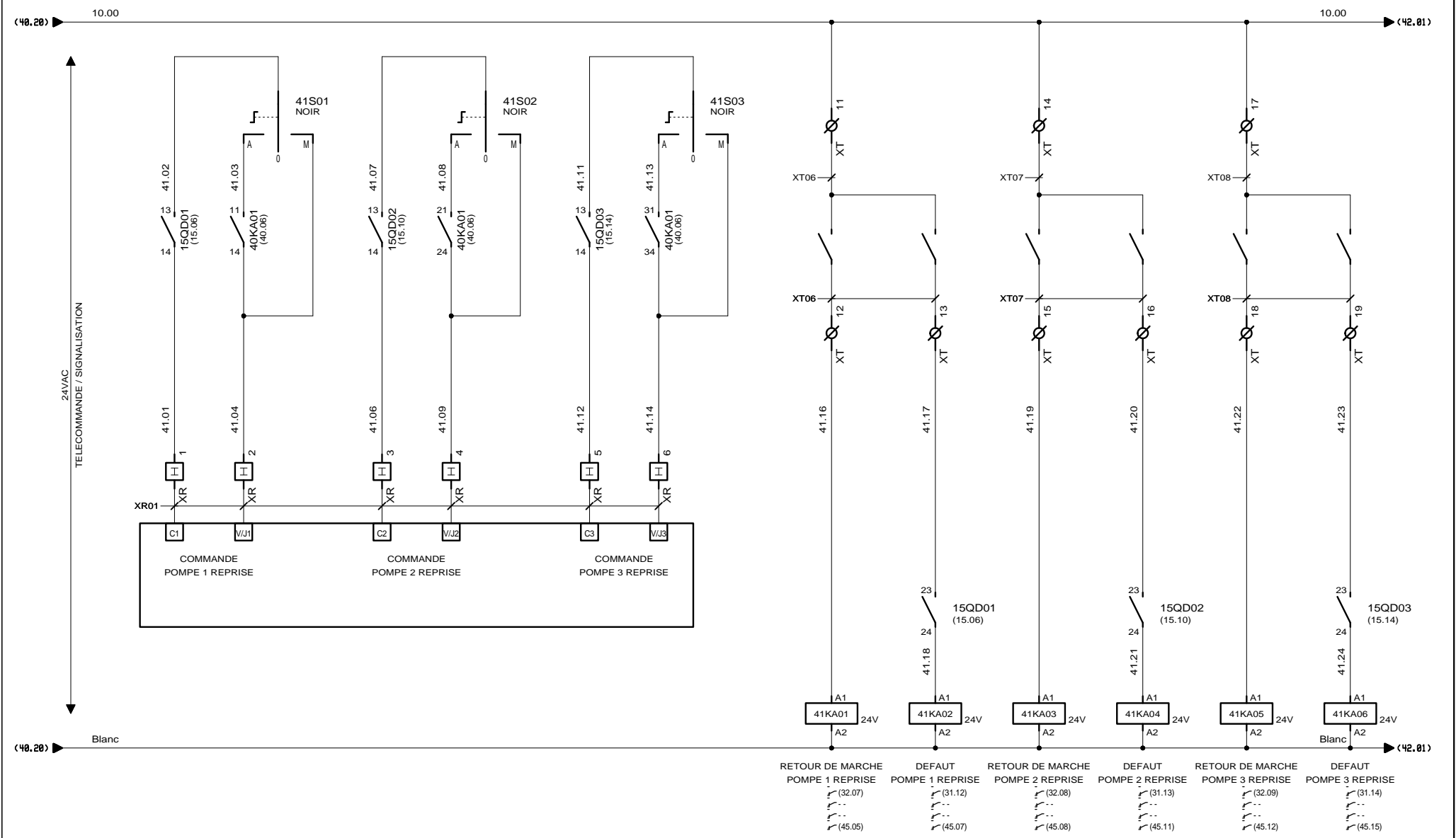

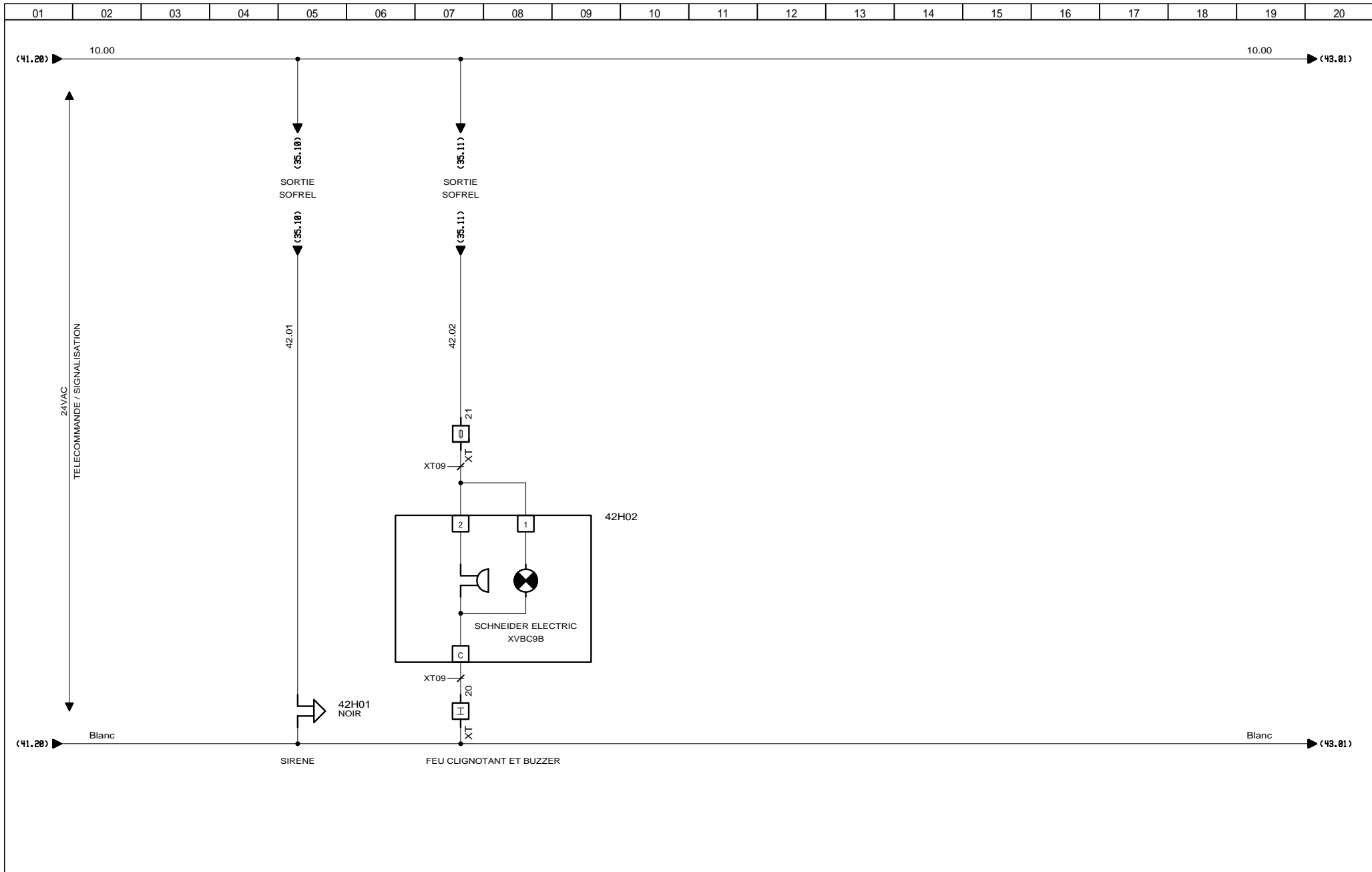

3, Rue Pierre Curie
 91230 MONTGERON
 Tél. : 01.69.52.47.00 - Fax : 01.69.52.47.01
 e-mail : seguin@automatismes-seguin.fr
 http://www.automatismes-seguin.fr

TELECOMMANDE

CLIENT ET NOM DU DOSSIER / CUSTOMER AND NAME OF FOLDER		INDICE / REVIEW
SAUR Coffret Reprise QUINCY		O
DESSINATEUR DRAWER	F.C.	IGE XAO
N° AFFAIRE N° PROJECT	170096	FOLIO/SHEET 42 / 43
		V4R2

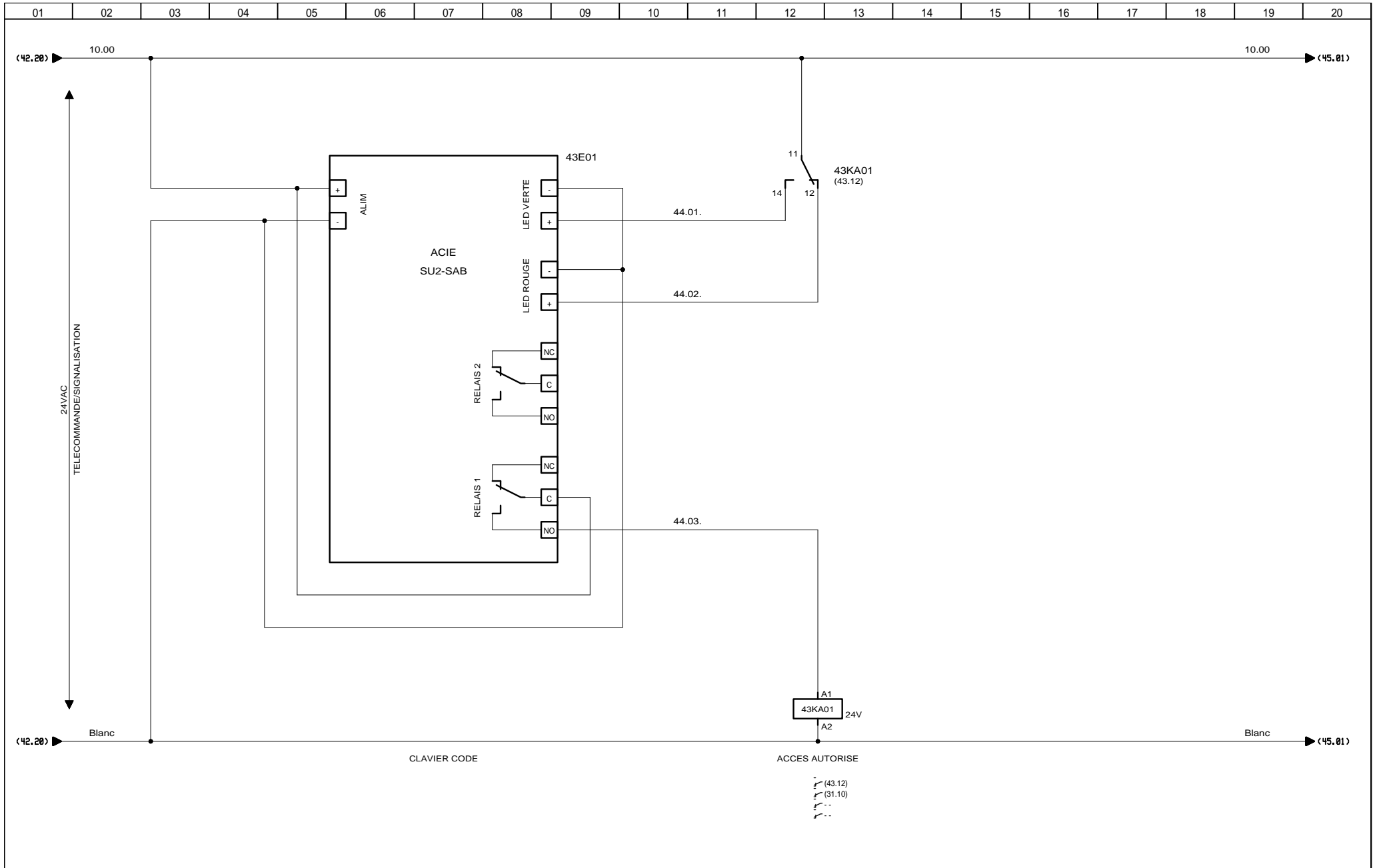

3, Rue Pierre Curie
 91230 MONTGERON
 Tél. : 01.69.52.47.00 - Fax : 01.69.52.47.01
 e-mail : seguin@automatismes-seguin.fr
 http://www.automatismes-seguin.fr

TELECOMMANDE INTRUSION

CLIENT ET NOM DU DOSSIER / CUSTOMER AND NAME OF FOLDER		INDICE / REVIEW
SAUR Coffret Reprise QUINCY		0
DESSINATEUR DRAWER	F.C.	IGE-XAO
N° AFFAIRE N° PROJECT	170096	
FOLIO/SHEET 43 / 44		V4R2

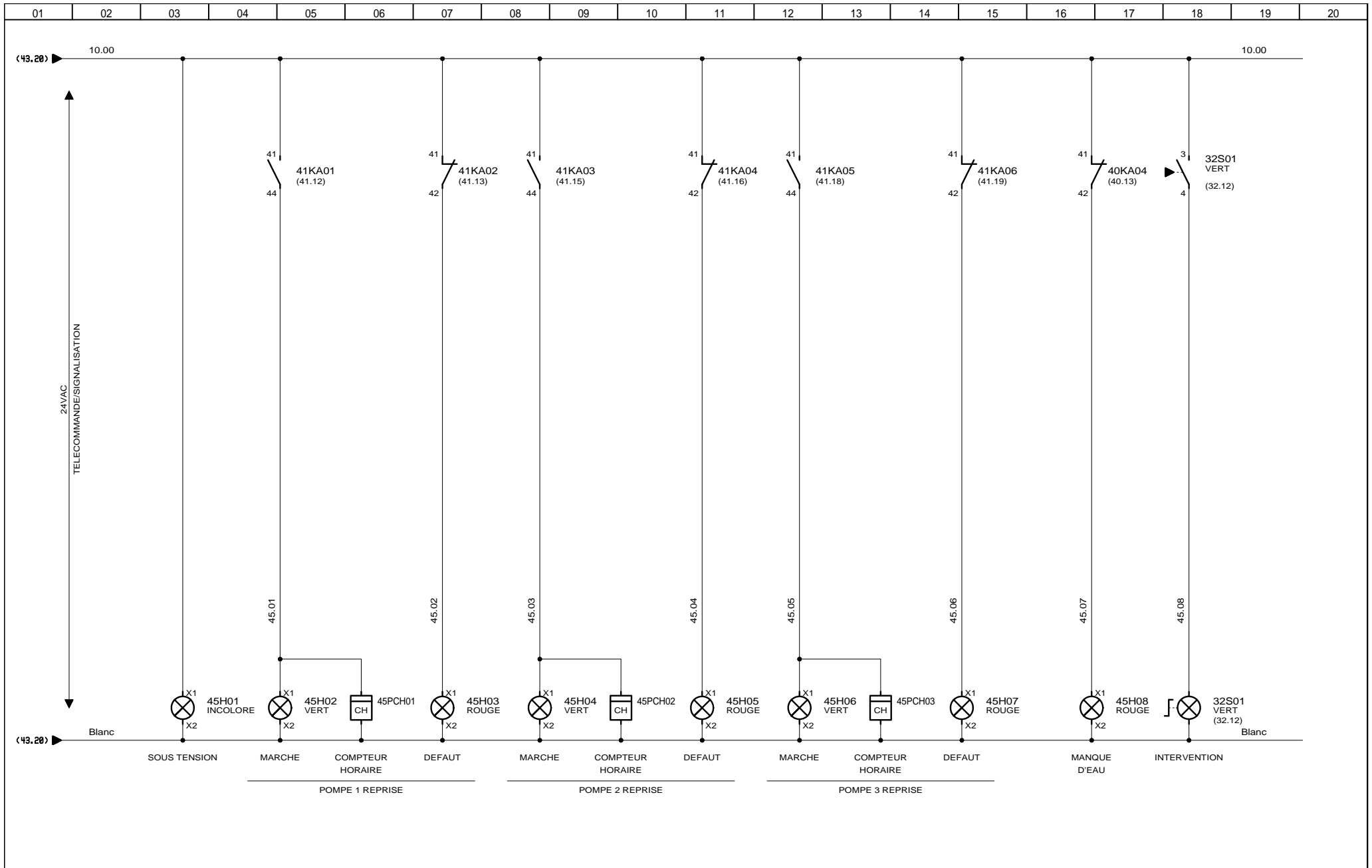

3, Rue Pierre Curie
91230 MONTGERON
Tél. : 01.69.52.47.00 - Fax : 01.69.52.47.01
e-mail : seguin@automatismes-seguin.fr
http://www.automatismes-seguin.fr

SIGNALISATION

CLIENT ET NOM DU DOSSIER / CUSTOMER AND NAME OF FOLDER		INDICE / REVIEW
SAUR Coffret Reprise QUINCY		0
DESSINATEUR DRAWER	F.C.	IGE-XAO
N° AFFAIRE N° PROJECT	170096	
FOLIO/SHEET 45 / 50		VAR2

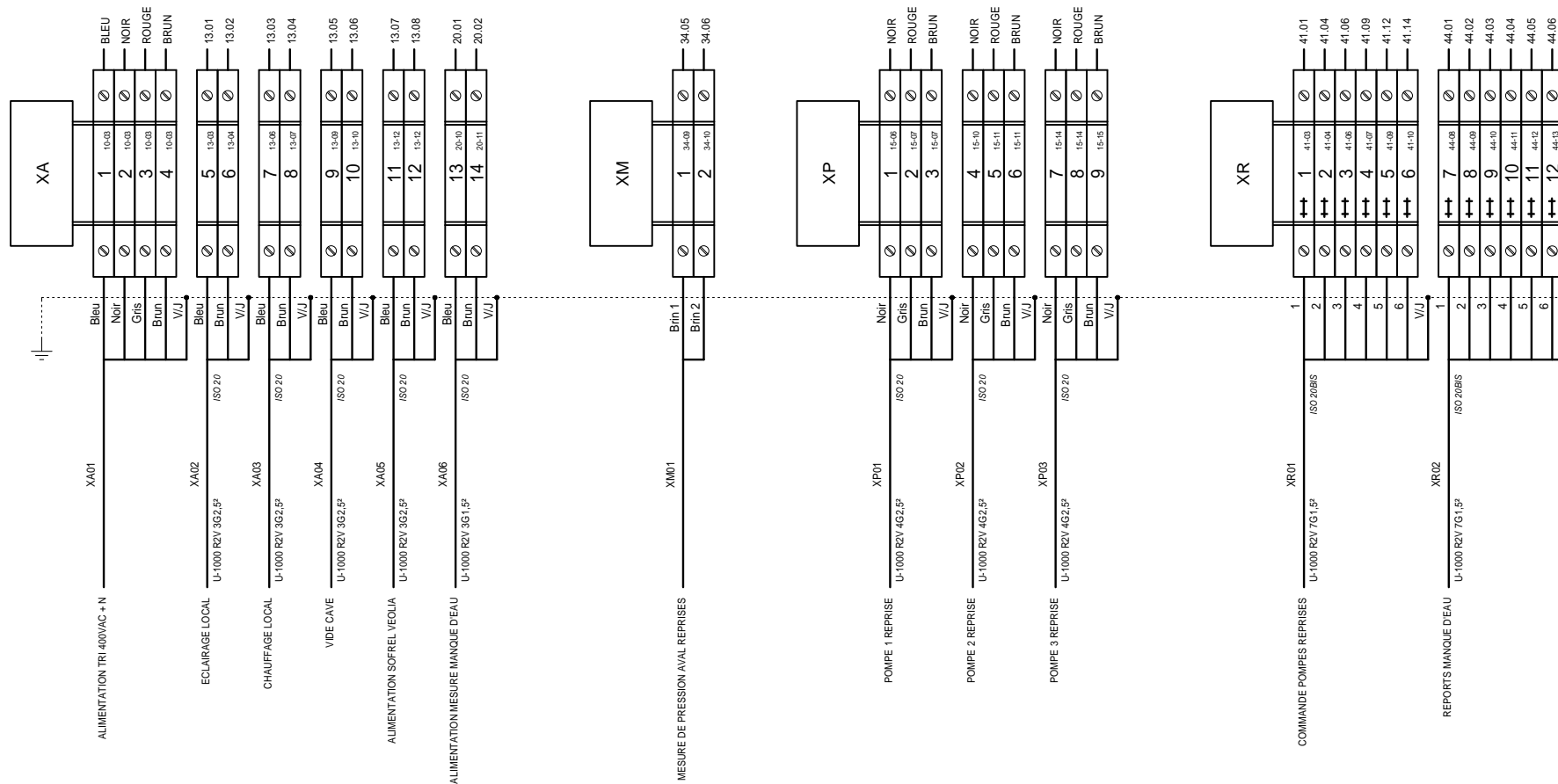

BORNIERES

AUTOMATISMES SEGUIN
 Systeme Qualité
 3, Rue Pierre Curie
 91230 MONTGERON
 Tél. : 01.69.52.47.00 - Fax : 01.69.52.47.01
 e-mail : seguin@automatismes-seguin.fr
 http://www.automatismes-seguin.fr

CLIENT ET NOM DU DOSSIER / CUSTOMER AND NAME OF FOLDER		INDICE / REVIEW
SAUR Coffret Reprise QUINCY		0
DESSINATEUR DRAWER	F.C.	IGE XAO
N° AFFAIRE N° PROJECT	170096	
FOLIO/SHEET 50 / 51		VARZ

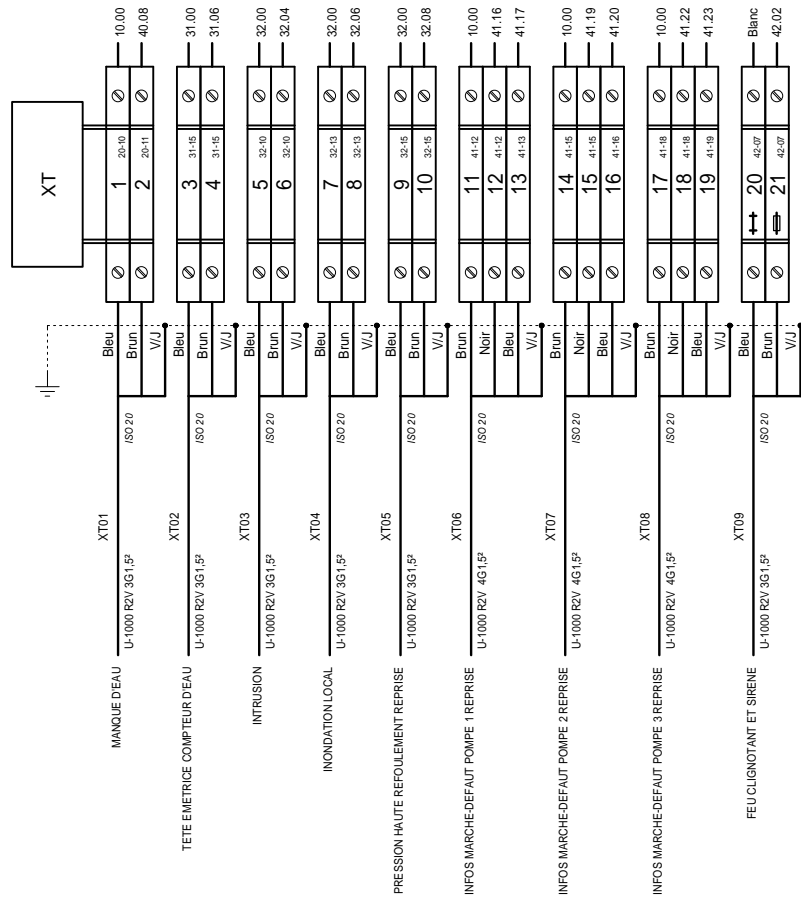

BORNERS

REPERE	DESIGNATION	REFERENCE	MARQUE	QTE
	TOLERIE			
	COFFRET UNIVERSEL AVEC PORTE PLEINE SANS CHASSIS 1000x800x300, IP66, RAL7035	NSYS3D10830	SCHNEIDER ELECTRIC	1
	POCHETTE OUVERTE POUR PLANS AUTOCOLLANTE, 340x235mm (ACC D'ENVELOPPES)	036580	LEGRAND	1
	POIGNEE A CLE 1242E	NSYAEDL1242S3D	SCHNEIDER ELECTRIC	1
	SOCLE FRONTAL SF/SM 200x800	NSYSPF8200	SCHNEIDER ELECTRIC	1
	JEU 4 TRAPPES LATERALES SOCLE SD 200X300	NSYSPS3200SD	SCHNEIDER ELECTRIC	1
10E01	REPARTITEUR TETRAPOLAIRE 100/125ALL, 14 CONNEXIONS	563840	ERICO	1
10KA01	RELAIS INDUSTRIEL EMBROCHABLE, MONOSTABLE, 4INV, 24VAC + EMBASE	RMIA4524AC + ZMI4SA	CARLO GAVAZZI	1
10KA02	RELAIS TEMPORISE ELECTRONIQUE STATIQUE AU TRAVAIL 0.1-100h, 24-240V AC/DC	RE17LAMW	SCHNEIDER ELECTRIC	1
10PF01	RELAIS DE CONTROLE TRIPHASE POUR L'ORDRE ET LA PERTE DE PHASES, 208-480VAC, 1INV	DPA51CM44	CARLO GAVAZZI	1
10PV01	VOLTMETRE ROTEX R72A90-V, ALTERNATIF 0-500V DIRECT DEV 90D	192G2107	SOCOMEK	1
	2 CAPUCHONS	192Z1016	SOCOMEK	1
10QD01	DISJONCTEUR IC60N 4P 1A, 440VAC/25kA, 250VDC/6kA, COURBE C	A9F74401	SCHNEIDER ELECTRIC	1
10QD03	DISJONCTEUR IC60N 2P 2A, 440VAC/25kA, 133VDC/6kA, COURBE C	A9F74202	SCHNEIDER ELECTRIC	1
10QD04	DISJONCTEUR DT40 1P+N 4A 6kA, COURBE C	A9N21022	SCHNEIDER ELECTRIC	1
10QIG01	INTERRUPTEUR DIFFERENTIEL IID TYPE AC 415VAC 4P 80A 300mA	A9R14480	SCHNEIDER ELECTRIC	1
10SV01	COMMUTATEUR VOLT 7POS VIS	192K0013	SOCOMEK	1
10TR01	TRANSFORMATEUR DE COMMANDE ET DE SIGNALISATION MONOPHASEE 230-400V/24-48V, 100VA	044233	LEGRAND	1
12ECH01	RESISTANCE CHAUFFANTE PTC CS 060, 120-240V AC/DC, 50W	06000.0-00	STEGO	1
12ECL01	LAMPE RENTABLE 14W 220V 50-60Hz 650lm	NSYLAM14T5	SCHNEIDER ELECTRIC	1
12KIH01	INTERRUPTEUR HORAIRE PROGRAMMABLE AUTOMATIQUE, 230VAC, 1 SORTIE 16A, 3 MODULES	412823	LEGRAND	1
12KTH01	PETIT THERMOSTAT KTO 011, 1NF, 0..60°C	01146.9-00	STEGO	1
12QD01	DISJONCTEUR DT40 1P+N 16A 6kA, COURBE C	A9N21025	SCHNEIDER ELECTRIC	1
	BLOC VIGI DT40 1P+N CLASSE AC 25A 30mA 230VAC	A9N21450	SCHNEIDER ELECTRIC	1
12QD02	DISJONCTEUR DT40 1P+N 1A 6kA, COURBE C	A9N21019	SCHNEIDER ELECTRIC	1
12QD03	DISJONCTEUR DT40 1P+N 2A 6kA, COURBE C	A9N21020	SCHNEIDER ELECTRIC	1
12QD04	DISJONCTEUR DT40 1P+N 1A 6kA, COURBE C	A9N21019	SCHNEIDER ELECTRIC	1
12S01	CONTACT DE PORTE	NSYINLCRN	SCHNEIDER ELECTRIC	1
12X01	PRISE DE COURANT 2P+T 10/16A, 250VAC A ECLIPS	004280	LEGRAND	1
13QD01	DISJONCTEUR DT40 1P+N 10A 6kA COURBE C	A9N21024	SCHNEIDER ELECTRIC	1
13QD02	DISJONCTEUR DT40 1P+N 10A 6kA COURBE C	A9N21024	SCHNEIDER ELECTRIC	1
13QD03	DISJONCTEUR DT40 1P+N 16A 6kA, COURBE C	A9N21025	SCHNEIDER ELECTRIC	1
	BLOC VIGI DT40 1P+N CLASSE AC 25A 30mA 230VAC	A9N21450	SCHNEIDER ELECTRIC	1
	CONTACT AUXILIAIRE OF	A9N26924	SCHNEIDER ELECTRIC	1
13QD04	DISJONCTEUR DT40 1P+N 10A 6kA COURBE C	A9N21024	SCHNEIDER ELECTRIC	1
15QD01	DISJONCTEUR MOTEUR MAGNETO-THERMIQUE 20-25A, BORNES A VIS	GV2ME22	SCHNEIDER ELECTRIC	1
	ADDITIF FRONTAL F+F	GVAE20	SCHNEIDER ELECTRIC	1
15QD02	DISJONCTEUR MOTEUR MAGNETO-THERMIQUE 20-25A, BORNES A VIS	GV2ME22	SCHNEIDER ELECTRIC	1
	ADDITIF FRONTAL F+F	GVAE20	SCHNEIDER ELECTRIC	1
15QD03	DISJONCTEUR MOTEUR MAGNETO-THERMIQUE 20-25A, BORNES A VIS	GV2ME22	SCHNEIDER ELECTRIC	1
	ADDITIF FRONTAL F+F	GVAE20	SCHNEIDER ELECTRIC	1
20QD01	DISJONCTEUR DT40 1P+N 1A 6kA, COURBE C	A9N21019	SCHNEIDER ELECTRIC	1
30E01	RACK S550 8 EMPLACEMENTS AVEC ALIM SECTEUR 230VAC	T9950A100	SOFREL	1
	AUTOMATISME PROGRAMMABLE EN LANGAGE ST	TS9500A10	SOFREL	1
30E01-02	MODULE DE COMMUNICATION PSTN (RTC) 33.600 bps	V5900510	SOFREL	1
30E01-03	MODULE D'ENTREES, 8E TOR	V5900210	SOFREL	1
30E01-04	MODULE D'ENTREES, 8E TOR	V5900210	SOFREL	1
30E01-05	MODULE D'ENTREES, 8E TOR	V5900210	SOFREL	1



3, Rue Pierre Curie
91230 MONTGERON
Tél. : 01.69.52.47.00 - Fax : 01.69.52.47.01
e-mail : seguin@automatismes-seguin.fr
http://www.automatismes-seguin.fr

NOMENCLATURE

CLIENT ET NOM DU DOSSIER / CUSTOMER AND NAME OF FOLDER		INDICE / REVIEW
SAUR		0
Coffret Reprise QUINCY		
DESSINATEUR DRAWER	F.C.	IGE XAO
N° AFFAIRE N° PROJECT	170096	VAR2
FOLIO/SHEET 60 / 61		

REPERE	DESIGNATION	REFERENCE	MARQUE	QTE
30E01-06	MODULE D'ENTREES, 2E ANA MULTISTANDARD	V5900260	SOFREL	1
30E01-07	MODULE DE SORTIES, 4S TOR 1S TOR WDG 50V 1A	V5900310	SOFREL	1
30FP01	PROTECTION SECTEUR 230V, 5kA, Up=1.2kV	T5300011	SOFREL	1
30FP02	PROTECTION RTC	T5300012	SOFREL	1
30G01	BATTERIE 12V, 7Ah	NP7-12	YUASA	1
30QD01	DISJONCTEUR DT40 1P+N 4A 6kA, COURBE C	A9N21022	SCHNEIDER ELECTRIC	1
30X01	PRISE TELEPHONIQUE SAILLIE - 8 CONTACTS	051219	LEGRAND	1
31S01	TETE BOUTON POUSSOIR JAUNE	ZB4BA5	SCHNEIDER ELECTRIC	1
	CORPS CONTACT NO	ZB4BZ101	SCHNEIDER ELECTRIC	1
32S01	TETE BOUTON TOURNANT LUMINEUX	ZB4BK1233	SCHNEIDER ELECTRIC	1
	CORPS POUSSOIR LUMINEUX	ZB4BW0B35	SCHNEIDER ELECTRIC	1
	CONTACT VIS ETRIER 1NO	ZBE101	SCHNEIDER ELECTRIC	1
34FP01	PROTECTION AI 4-20mA	T5300014	SOFREL	1
40KA01	RELAIS INDUSTRIEL EMBROCHABLE, MONOSTABLE, 4INV, 24VAC + EMBASE	RMIA4524AC + ZMI4SA	CARLO GAVAZZI	1
40KA02	RELAIS INDUSTRIEL EMBROCHABLE, MONOSTABLE, 4INV, 24VAC + EMBASE	RMIA4524AC + ZMI4SA	CARLO GAVAZZI	1
40KA03	RELAIS INDUSTRIEL EMBROCHABLE, MONOSTABLE, 4INV, 24VAC + EMBASE	RMIA4524AC + ZMI4SA	CARLO GAVAZZI	1
40KA04	RELAIS INDUSTRIEL EMBROCHABLE, MONOSTABLE, 4INV, 24VAC + EMBASE	RMIA4524AC + ZMI4SA	CARLO GAVAZZI	1
40KA05	RELAIS INDUSTRIEL EMBROCHABLE, MONOSTABLE, 4INV, 24VAC + EMBASE	RMIA4524AC + ZMI4SA	CARLO GAVAZZI	1
40S01	COMMUTATEUR LP	K1H014QLH	SCHNEIDER ELECTRIC	1
41KA01	RELAIS INDUSTRIEL EMBROCHABLE, MONOSTABLE, 4INV, 24VAC + EMBASE	RMIA4524AC + ZMI4SA	CARLO GAVAZZI	1
41KA02	RELAIS INDUSTRIEL EMBROCHABLE, MONOSTABLE, 4INV, 24VAC + EMBASE	RMIA4524AC + ZMI4SA	CARLO GAVAZZI	1
41KA03	RELAIS INDUSTRIEL EMBROCHABLE, MONOSTABLE, 4INV, 24VAC + EMBASE	RMIA4524AC + ZMI4SA	CARLO GAVAZZI	1
41KA04	RELAIS INDUSTRIEL EMBROCHABLE, MONOSTABLE, 4INV, 24VAC + EMBASE	RMIA4524AC + ZMI4SA	CARLO GAVAZZI	1
41KA05	RELAIS INDUSTRIEL EMBROCHABLE, MONOSTABLE, 4INV, 24VAC + EMBASE	RMIA4524AC + ZMI4SA	CARLO GAVAZZI	1
41KA06	RELAIS INDUSTRIEL EMBROCHABLE, MONOSTABLE, 4INV, 24VAC + EMBASE	RMIA4524AC + ZMI4SA	CARLO GAVAZZI	1
41S01	TETE BOUTON TOURNANT 3 POSITIONS	ZB4BD3	SCHNEIDER ELECTRIC	1
	CORPS CONTACT 2NO	ZB4BZ103	SCHNEIDER ELECTRIC	1
41S02	TETE BOUTON TOURNANT 3 POSITIONS	ZB4BD3	SCHNEIDER ELECTRIC	1
	CORPS CONTACT 2NO	ZB4BZ103	SCHNEIDER ELECTRIC	1
41S03	TETE BOUTON TOURNANT 3 POSITIONS	ZB4BD3	SCHNEIDER ELECTRIC	1
	CORPS CONTACT 2NO	ZB4BZ103	SCHNEIDER ELECTRIC	1
42H01	SIRENE ELECTROMECHANIQUE COURANT ALTERNATIF, 24VAC	041536	LEGRAND	1
42H02	EMBASE ET COUVERCLE	XVBC21	SCHNEIDER ELECTRIC	1
	ELEMENT LUMINEUX A SIGNALISATION CLIGNOTANTE, DEL INTEGREE, 24V AC/DC, ROUGE	XVBC5B4	SCHNEIDER ELECTRIC	1
	ELEMENT SONORE	XVBC9B	SCHNEIDER ELECTRIC	1
	TUBE ALUMINIUM DIA. 25mm AVEC SOCLE PLASTIQUE NOIR, 80mm, ALUMINIUM NOIR	XVBZ02	SCHNEIDER ELECTRIC	1
43E01	CLAVIER POUR ALARME ET CONTROLE D'ACCES 60 CODES, 2 RELAIS	SU2-SAB	ACIE	1
43KA01	RELAIS INDUSTRIEL EMBROCHABLE, MONOSTABLE, 4INV, 24VAC + EMBASE	RMIA4524AC + ZMI4SA	CARLO GAVAZZI	1
45H01	VOYANT INCOLORE DEL 24V	XB7EV07BP	SCHNEIDER ELECTRIC	1
45H02	VOYANT VERT DEL 24V	XB7EV03BP	SCHNEIDER ELECTRIC	1
45H03	VOYANT ROUGE DEL 24V	XB7EV04BP	SCHNEIDER ELECTRIC	1
45H04	VOYANT VERT DEL 24V	XB7EV03BP	SCHNEIDER ELECTRIC	1
45H05	VOYANT ROUGE DEL 24V	XB7EV04BP	SCHNEIDER ELECTRIC	1
45H06	VOYANT VERT DEL 24V	XB7EV03BP	SCHNEIDER ELECTRIC	1
45H07	VOYANT ROUGE DEL 24V	XB7EV04BP	SCHNEIDER ELECTRIC	1
45H08	VOYANT ROUGE DEL 24V	XB7EV04BP	SCHNEIDER ELECTRIC	1
45PCH01	COMPTEUR HORAIRE TOTALISATEUR 10...30V, 50Hz	3220401071	KUBLER	1



3, Rue Pierre Curie
91230 MONTGERON
Tél. : 01.69.52.47.00 - Fax : 01.69.52.47.01
e-mail : seguin@automatismes-seguin.fr
http://www.automatismes-seguin.fr

NOMENCLATURE

CLIENT ET NOM DU DOSSIER / CUSTOMER AND NAME OF FOLDER		INDICE / REVIEW
SAUR		0
Coffret Reprise QUINCY		
DESSINATEUR DRAWER	F.C.	FOLIO/SHEET 61 / 62
N° AFFAIRE N° PROJECT	170096	
		IGE-XAO VAR2

