





LETTRE DE REPERAGE DES ELEMENTS DU SCHEMA

QI	INTERRUPTEUR	PCPI	CONTROLEUR D'ISOLEMENT	KT	RELAIS TEMPORISE	SA	COMMUTATEUR D'AMPEREMETRE
QIG	INTERRUPTEUR GENERAL	TR	TRANSFORMATEUR DE TENSION	KAU	RELAIS ARRÊT D'URGENCE	SV	COMMUTATEUR DE VOLTMETRE
QD	DISJONCTEUR	TC	TRANSFORMATEUR DE COURANT	UF	VARIATEUR	ECH	RESISTANCE CHAUFFANTE
QDG	DISJONCTEUR GENERAL	U	ONDULEUR, ALIMENTATION	UM	DEMARREUR	ECL	ECLAIRAGE
FP	PARAFONDRE	KIC	INTER CREPUSCULAIRE	S	ORGANE DE COMMANDE	G	BATTERIE
FU	FUSIBLE	KIH	HORLOGE	H	VOYANT, SIRENE	P	INSTRUMENTATION
F	THERMIQUE	KTH	THERMOSTAT	PCH	COMPTEUR HORAIRE	X	PRISE DE COURANT, BORNIER
QF	SECTIONNEUR FUSIBLE	KM	CONTACTEUR	PA	AMPEREMETRE	E	MATERIELS AUTRES
PF	CONTROLEUR DE PHASE	KA	RELAIS	PV	VOLTMETRE	KTL	TELERUPTEUR

LETTER CODES FOR ITEMS DESIGNATION ON THE DRAWING

QI	SWITCH	PCPI	INSULATION CONTROLLER	KT	TEMPORIZES RELAY	SA	AMPEREMETER SWITCH
QIG	GENERAL SWITCH	TR	TENSION TRANSFORMER	KAU	EMERGENCY STOP RELAY	SV	VOLTMETER SWITCH
QD	BREAKER	TC	CURRENT TRANSFORMER	UF	VELOCITY VARIATOR	ECL	LIGHT
QDG	GENERAL BREAKER	U	INVERTER, SUPPLY	UM	MOTOR STARTER	ECH	HEATER
FP	LIGHTNING PROTECTOR	KIC	DIMMER	S	CONTROL UNIT	G	BATTERY
FU	FUSE	KIH	CLOCK	H	INDICATOR	P	INSTRUMENTATION
F	THERMAL RELAY	KTH	THERMOSTAT	PCH	TIMER	X	SOCKET, TERMINAL BLOCK
QF	DISCONNECTING SWITCH	KM	CONTACTOR	PA	AMPEREMETER	E	OTHER EQUIPMENTS
PF	PHASE CONTROLLER	KA	RELAY	PV	VOLTMETER	KTL	TELEBREAKER

COULEURS DE FILS

TRI 400V: <= 6 mm2 Noir Rouge Brun  
> 6 mm2 Noir Bagué Noir Rouge Brun

NEUTRE: Bleu Clair

230VAC: Rouge avec Commun Bobines Blanc (\*)

230VAC ONDULE: Neutre Bleu Clair Bagué Orange  
Phase Noir Bagué Orange

110VAC: Noir avec Commun Bobines Blanc (\*)

24VAC: Violet avec Commun Bobines Blanc (\*)

24VDC: Bleu Foncé avec Commun Bobines Blanc (\*)

48VAC: Violet avec Commun Bobines Blanc (\*)

48VDC: Bleu Foncé avec Commun Bobines Blanc (\*)

REPORTS: Orange

TERRE: Vert/Jaune

ANALOGIQUE: Une Paire + Brun - Blanc  
Unifilaire Blanc

TENSION EXTERNE PERMANENTE INTER GENERAL OUVERT: Orange

ATTENTION

Si plusieurs tensions de télécommande, alors prendre uniquement le 230VAC avec Commun Bobines Blanc

(\*) Si Télécommande

WIRE COLOR

TRI 400V: <= 6 mm2 Black Red Brown  
> 6 mm2 Black with Ring Black Red Brown

NEUTRE: Light Blue

230VAC: Red with Spods Common White (\*)

230VAC UPS: Neutre Light Blue with Ring Orange  
Phase Black with Ring Orange

110VAC: Black with Spods Common White (\*)

24VAC: Purple with Spods Common White (\*)

24VDC: Dark Bleu with Spods Common White (\*)

48VAC: Purple with Spods Common White (\*)

48VDC: Dark Bleu with Spods Common White (\*)

REPORTS: Orange

GROUND: Green/Yellow

ANALOGICAL: One Pair + Brown - White  
Unifilar White

PERMANENTLY EXTERNAL POWER GENERAL BREAKER OPEN: Orange

CAUTION

If There are Several Tensions of Command Then to take Only the 230VAC with Spods Common White

(\*) If Command

TYPE DE RELAIS ET DE CONTACT DANS LE SCHEMA



RELAY AND CONTACT TYPE IN THE DRAWING

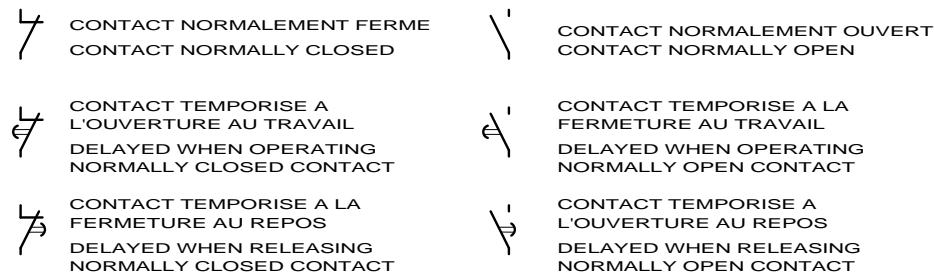

LE SCHEMA EST REPRESENTÉ HORS TENSION ET GENERATEUR HORS SERVICE

THE DRAWING IS SHOWN OUT OF VOLTAGE AND WITH GENERATOR OUT OF SERVICE



3, Rue Pierre Curie  
91230 MONTGERON  
Tél. : 01.69.52.47.00 - Fax : 01.69.52.47.01  
e-mail : seguin@automatismes-seguin.fr  
http://www.automatismes-seguin.fr

LEGENDE DU SCHEMA ELECTRIQUE

CLIENT ET NOM DU DOSSIER / CUSTOMER AND NAME OF FOLDER		INDICE / REVIEW
SAUR		0
Coffret petit LORIBEAU		
DESSINATEUR / DRAWER	K.C.	IGE-XAO
N° AFFAIRE / N° PROJECT	190464	FOLIO/SHEET 03/04
		VARS SERVICE PACK 4 - (L84C)

CODE DU REPERAGE

LETTER CODE

1/ DES APPAREILS DANS LES ARMOIRES  
APPARATUS IN THE CABINETS

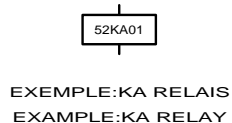

52 KA 01

N° D'ORDRE DANS LE FOLIO D'ORIGINE  
ORDER NUMBER ON ORIGINAL SHEET

LETTRE DE REPERAGE  
LETTER CODES FOR ITEM

N° DU FOLIO D'ORIGINE  
ORIGINAL SHEET NUMBER

2/ DES FILS DE CABLAGE  
WIRING

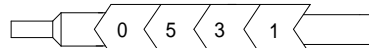

N° DU FOLIO D'ORIGINE  
ORIGINAL SHEET NUMBER

N° DU FIL DANS LE FOLIO D'ORIGINE  
NUMBER OF THE WIRE ON ORIGINAL SHEET

3/ REPORT DES CONTACTS DANS LE SCHEMA  
CONTACT REPORT IN THE DRAWING



17.29

N° DE LA COLONNE OU EST UTILISE LE CONTACT  
COLUMN NUMBER WHERE THE CONTACT IS USED

N° DU FOLIO OU EST UTILISE LE CONTACT  
SHEET NUMBER WHERE THE CONTACT IS USED

4/ REPRESENTATION DES BORNES ET BORNIERES DANS LE SCHEMA  
BINDINGS SCREWS VIEW IN THE DRAWING



N° D'ORDRE (SI NECESSAIRE)  
ORDER NUMBER (IF NECESSARY)

NATURE DU BORNIER  
NATURE OF TERMINAL BLOCK

- A : ALIMENTATION
- P : PUISSANCE
- T : TELECOMMANDE
- M : MESURE
- R : REPORTS



LE SCHEMA EST REPRESENTE HORS TENSION ET GENERATEUR HORS SERVICE

THE DRAWING IS SHOWN OUT OF VOLTAGE AND WITH GENERATOR OUT OF SERVICE



3, Rue Pierre Curie  
91230 MONTGERON  
Tél. : 01.69.52.47.00 - Fax : 01.69.52.47.01  
e-mail : seguin@automatismes-seguin.fr  
http://www.automatismes-seguin.fr

## LEGENDE DU SCHEMA ELECTRIQUE

CLIENT ET NOM DU DOSSIER / CUSTOMER AND NAME OF FOLDER		INDICE / REVIEW
SAUR		0
Coffret petit LORIBEAU		
DESSINATEUR DRAWER	K.C.	FOLIO/SHEET 04/05
N° AFFAIRE N° PROJECT	190464	
		IGE XAO VAR3 SERVICE PACK 4 - (L84C)

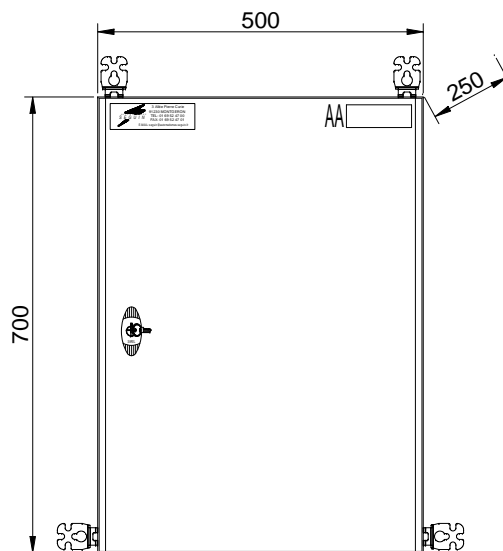

ETIQUETTE 200x30

AA - PETIT LORIBEAU

IMPLANTATION FACADE



3, Rue Pierre Curie  
91230 MONTGERON  
Tél. : 01.69.52.47.00 - Fax : 01.69.52.47.01  
e-mail : seguin@automatismes-seguin.fr  
http://www.automatismes-seguin.fr

IMPLANTATION EXTERNE

CLIENT ET NOM DU DOSSIER / CUSTOMER AND NAME OF FOLDER		INDICE / REVIEW
SAUR Coffret petit LORIBEAU		0
DESSINATEUR DRAWER	K.C.	FOLIO/SHEET 05 / 10
N° AFFAIRE N° PROJECT	190464	
		IGE XAO VARS SERVICE PACK 4 - (A,B,C)

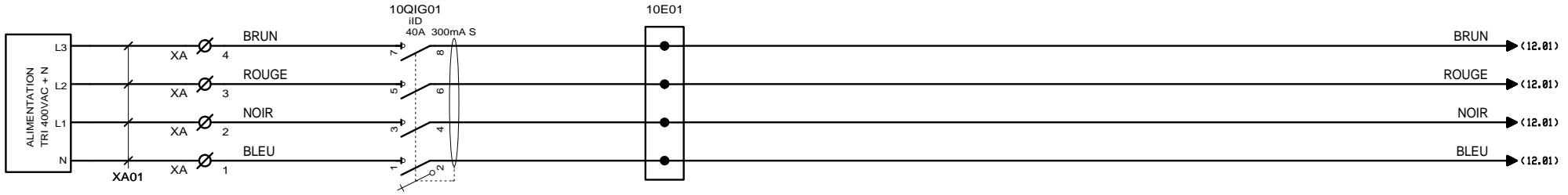

TARIF : Bleu  
 Ik3 :  
 Ik1 :  
 REGIME DE NEUTRE : TT  
 COMPTAGE :

**ARRIVEE 230VAC**

CLIENT ET NOM DU DOSSIER / CUSTOMER AND NAME OF FOLDER		INDICE / REVIEW
SAUR Coffret petit LORIBEAU		0
DESSINATEUR DRAWER	K.C.	FOLIO/SHEET 10 / 12
N° AFFAIRE N° PROJECT	190464	
		IGE XAO VAR3 SERVICE PACK 4 - (4.843)

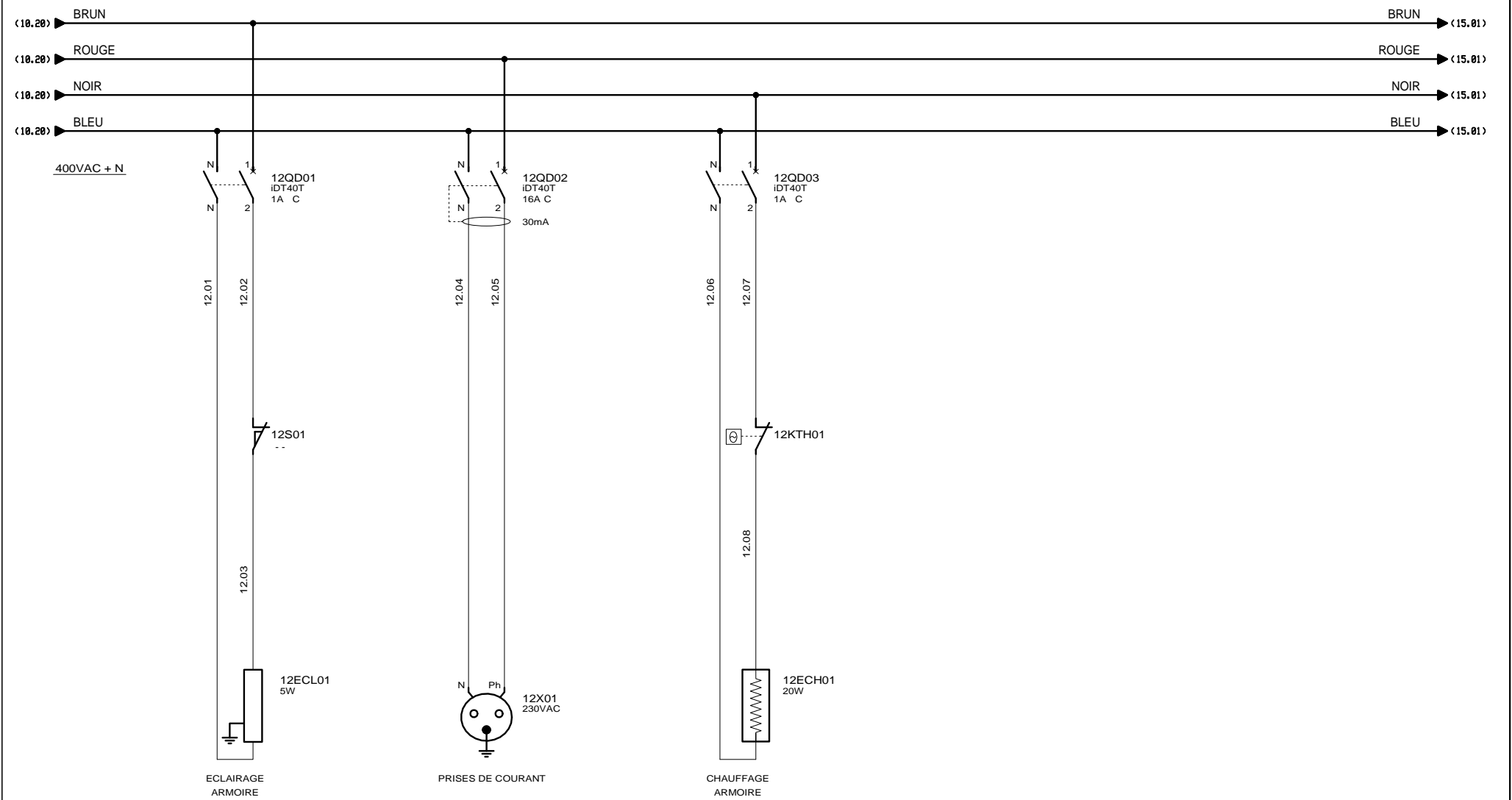

**AUTOMATISMES SEGUIN**  
 Systeme Qualité  
 3, Rue Pierre Curie  
 91230 MONTGERON  
 Tél. : 01.69.52.47.00 - Fax : 01.69.52.47.01  
 e-mail : seguin@automatismes-seguin.fr  
 http://www.automatismes-seguin.fr

**DISTRIBUTION 400VAC+N  
 UTILITES**

CLIENT ET NOM DU DOSSIER / CUSTOMER AND NAME OF FOLDER		INDICE / REVIEW
SAUR Coffret petit LORIBEAU		0
DESSINATEUR DRAWER	K.C.	FOLIO/SHEET 12 / 15
N° AFFAIRE N° PROJECT	190464	
VARS SERVICE PACK 4 - (4.843)		

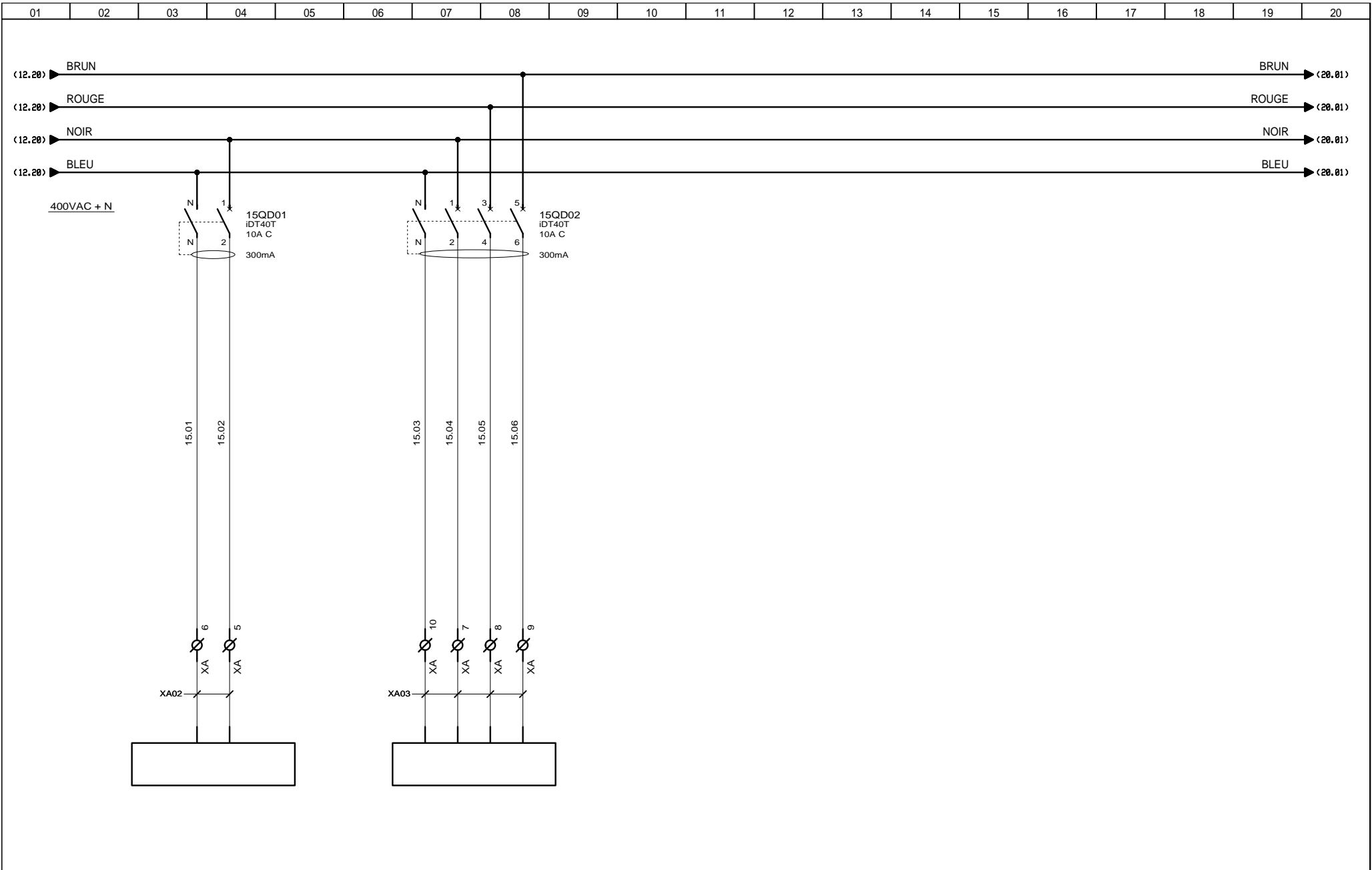



 3, Rue Pierre Curie  
 91230 MONTGERON  
 Tél. : 01.69.52.47.00 - Fax : 01.69.52.47.01  
 e-mail : seguin@automatismes-seguin.fr  
 http://www.automatismes-seguin.fr

### DISTRIBUTION 400VAC+N

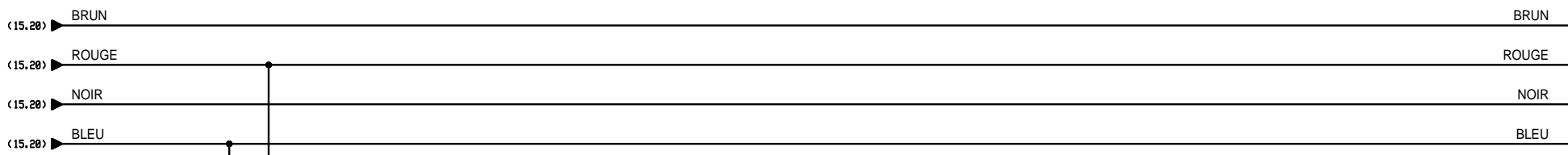
CLIENT ET NOM DU DOSSIER / CUSTOMER AND NAME OF FOLDER		INDICE / REVIEW
SAUR Coffret petit LORIBEAU		0
DESSINATEUR DRAWER	K.C.	FOLIO/SHEET 15 / 20
N° AFFAIRE N° PROJECT	190464	
		IGE-XAO VAR3 SERVICE PACK 4 - (4.843)

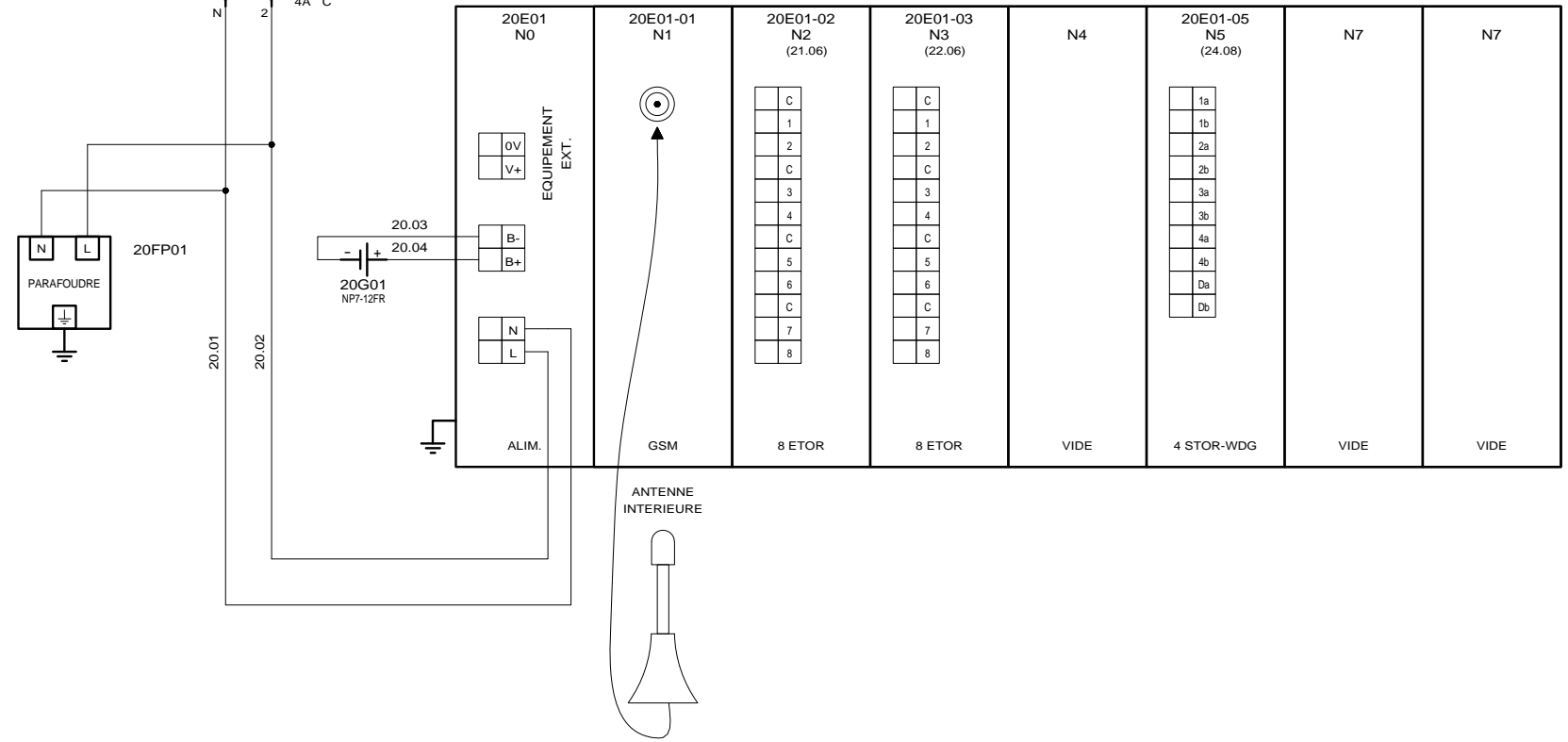

SOFREL S550 (VUE DE DESSOUS)



CONFIGURATION SOFREL

CLIENT ET NOM DU DOSSIER / CUSTOMER AND NAME OF FOLDER		INDICE / REVIEW
SAUR Coffret petit LORIBEAU		0
DESSINATEUR / DRAWER	K.C.	FOLIO/SHEET 20/21
N° AFFAIRE / N° PROJECT	190464	
		IGE-XAO VAR3 SERVICE PACK 4 - (4.843)

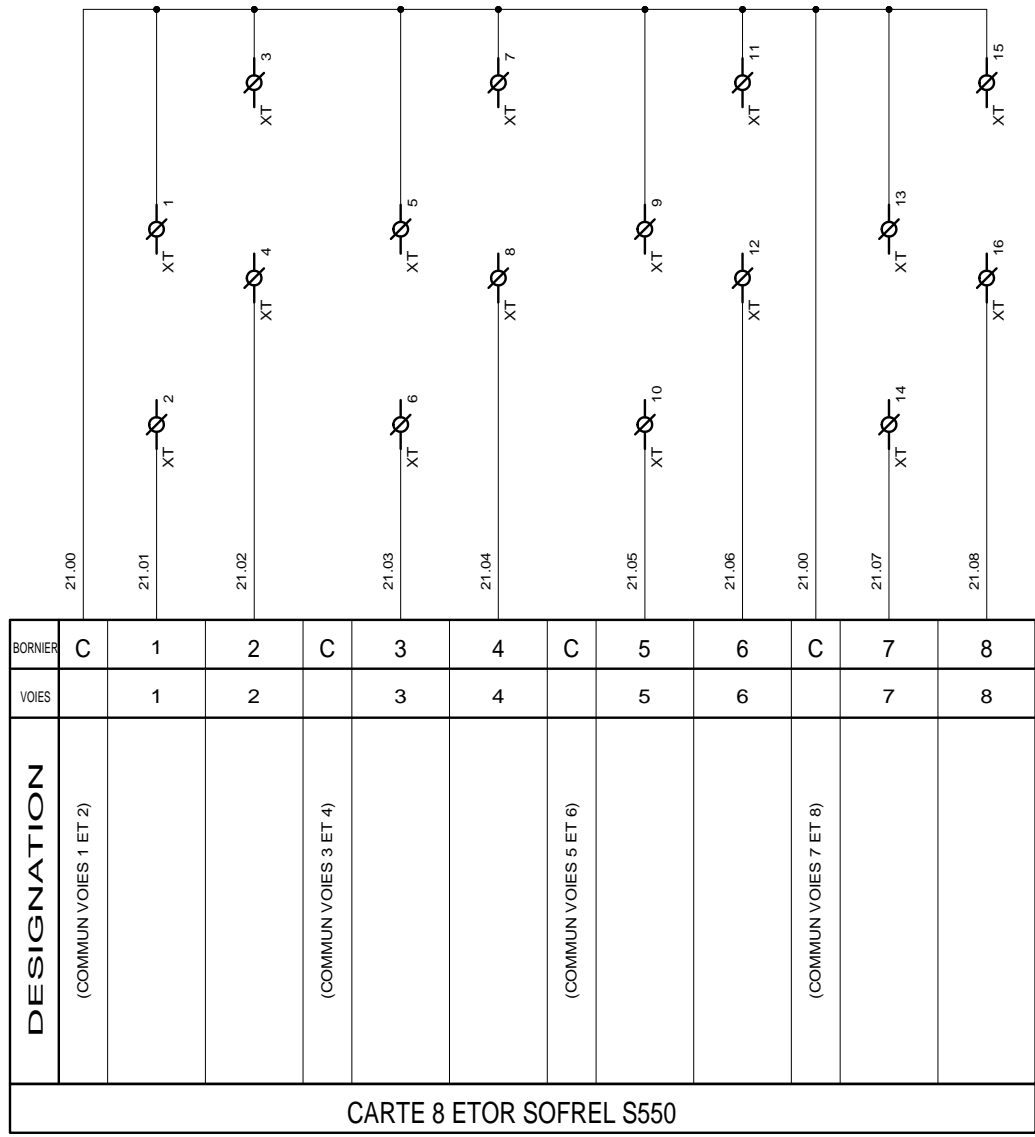

20E01-02  
(20.09)

CARTE 8 ETOR SOFREL S550

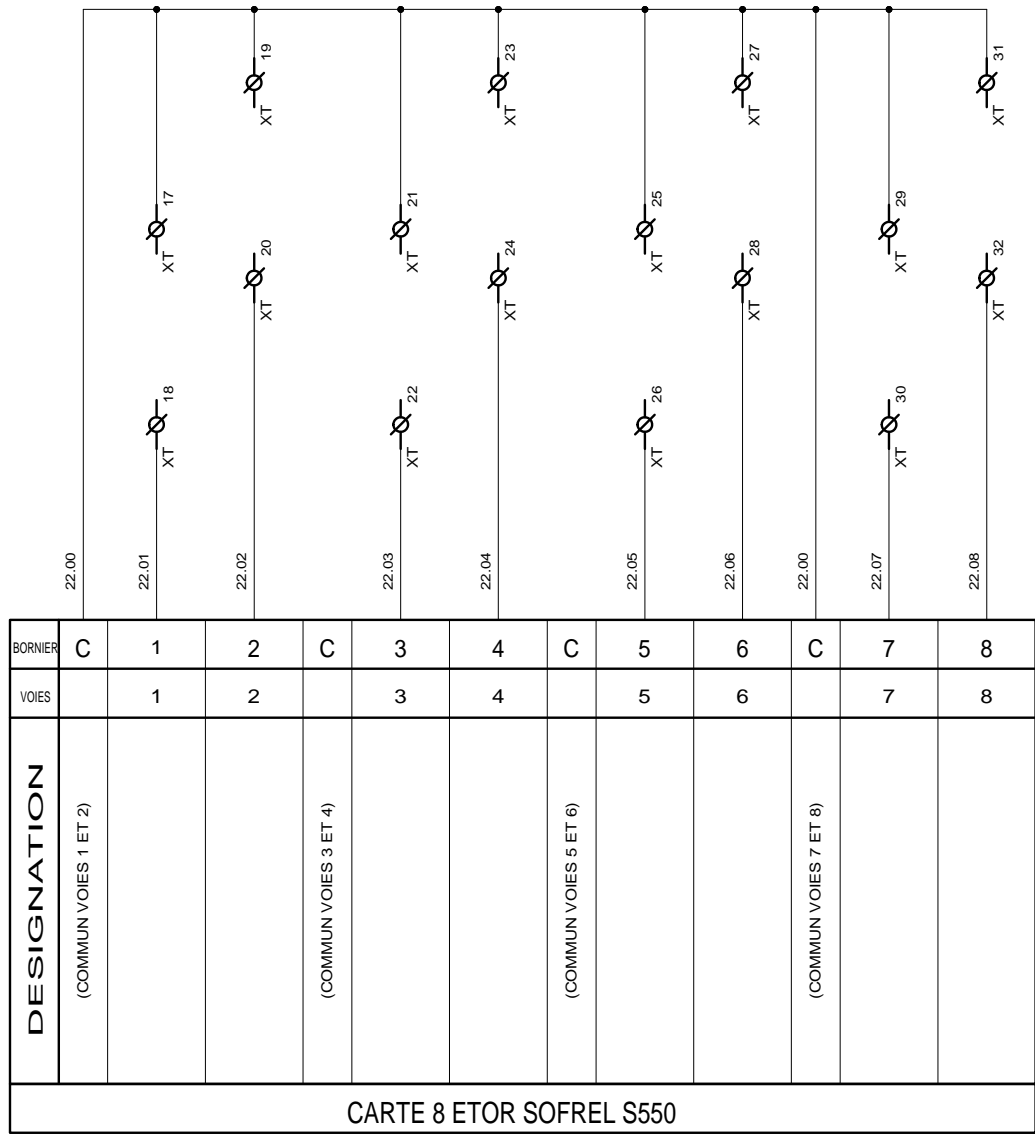

20E01-03  
(20.10)

### CARTE 8 ENTRES TOR EMPLACEMENT 3

CLIENT ET NOM DU DOSSIER / CUSTOMER AND NAME OF FOLDER		INDICE / REVIEW
SAUR Coffret petit LORIBEAU		0
DESSINATEUR DRAWER	K.C.	FOLIO/SHEET 22 / 24
N° AFFAIRE N° PROJECT	190464	
		VARS SERVICE PACK 4 - (4.84C)

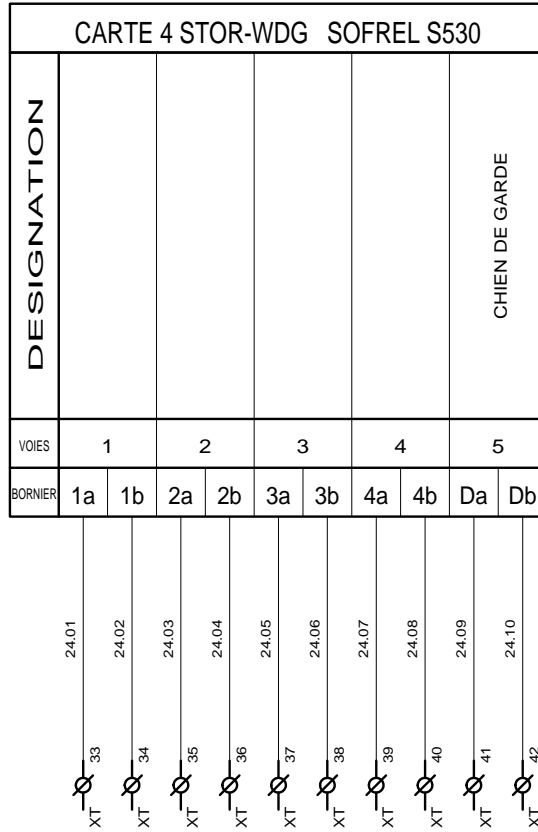

20E01-05  
(20.13)



3, Rue Pierre Curie  
91230 MONTGERON  
Tél. : 01.69.52.47.00 - Fax : 01.69.52.47.01  
e-mail : seguin@automatismes-seguin.fr  
http://www.automatismes-seguin.fr

### CARTE 4 SORTIES TOR EMPLACEMENT 5

CLIENT ET NOM DU DOSSIER / CUSTOMER AND NAME OF FOLDER		INDICE / REVIEW
SAUR Coffret petit LORIBEAU		0
DESSINATEUR DRAWER	K.C.	FOLIO/SHEET 24 / 40
N° AFFAIRE N° PROJECT	190464	
		VARS SERVICE PACK 4 - (A.843)

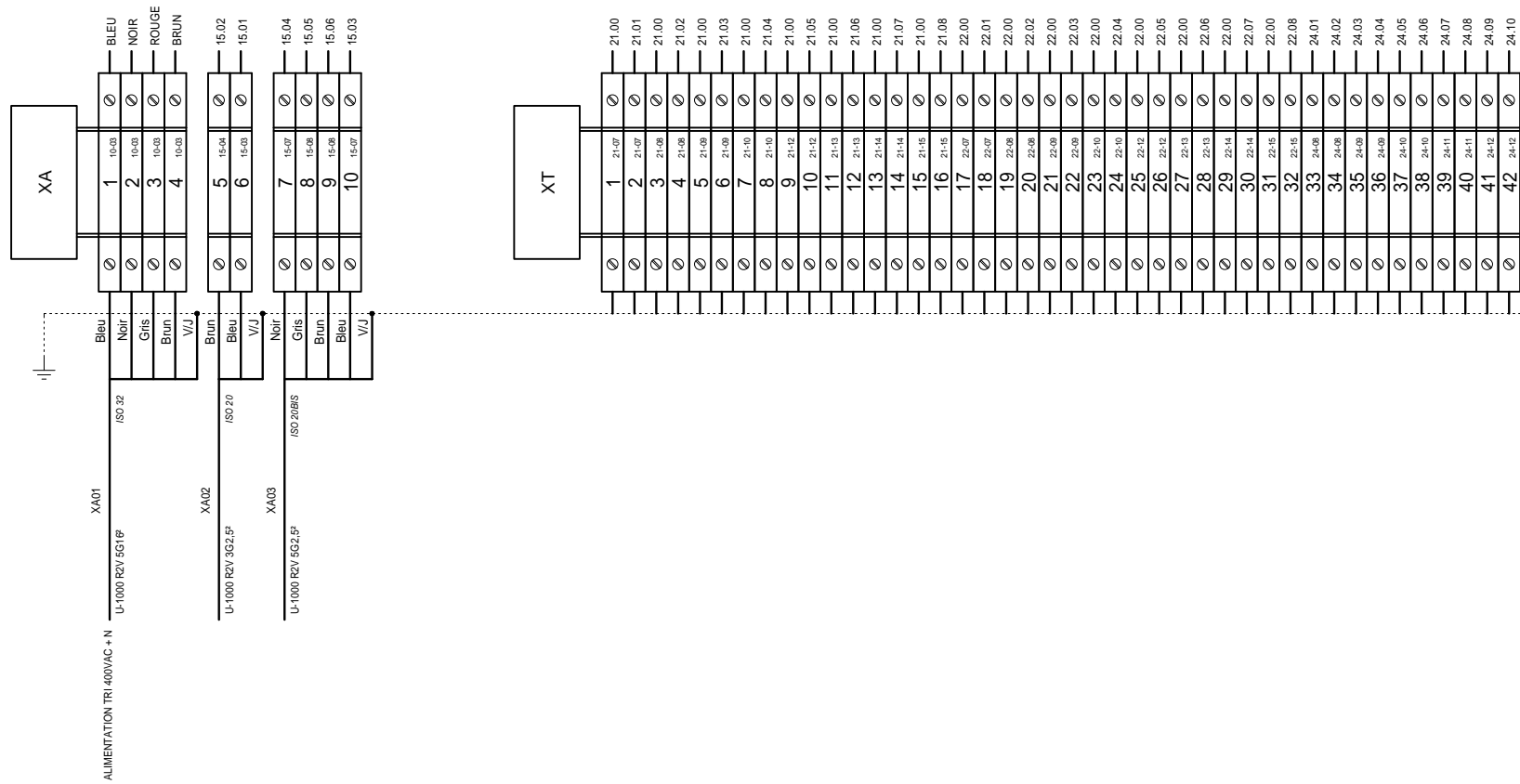

**BORNIERS**

3, Rue Pierre Curie  
91230 MONTGERON  
Tél. : 01.69.52.47.00 - Fax : 01.69.52.47.01  
e-mail : seguin@automatismes-seguin.fr  
http://www.automatismes-seguin.fr

CLIENT ET NOM DU DOSSIER / CUSTOMER AND NAME OF FOLDER		INDICE / REVIEW
SAUR Coffret petit LORIBEAU		0
DESSINATEUR DRAWER	K.C.	 VARS SERVICE PACK 4 - (4.84C)
N° AFFAIRE N° PROJECT	190464	
FOLIO/SHEET		40 / 45

