

19/11/2018	1	M.H.	RETOUR CHANTIER	F.C.	R.M.
09/10/2018	0	A.C.	RETOUR ESSAIS	F.C.	R.M.
12/07/2018	A	M.H.	PREMIERE EMISSION	F.C.	R.M.
DATE	REV.	DESSINE PAR	MODIFICATIONS	VERIFIE PAR	APPROUVE PAR
DATE	REV.	DRAWN BY	REVISIONS	CHECKED BY	APPROVED BY

SCHEMA ELECTRIQUE ELECTRICAL DRAWING



3, Rue Pierre Curie
91230 MONTGERON
Tél. : 01.69.52.47.00 - Fax : 01.69.52.47.01
e-mail : seguin@automatismes-seguin.fr
<http://www.automatismes-seguin.fr>

PLAN: 180253	REV: 1
CDE: 18084848	

Ce document est notre propriété. Il ne peut être reproduit et / ou communiqué sans autorisation.
This document is our property. It cannot be reproduced and / or transmitted without authorization.



Armoire De Surpression Du Ruvet

LETTRE DE REPERAGE DES ELEMENTS DU SCHEMA

QI	INTERRUPTEUR	PCPI	CONTROLEUR D'ISOLEMENT	KT	RELAIS TEMPORISE	SA	COMMUTATEUR D'AMPEREMETRE
QIG	INTERRUPTEUR GENERAL	TR	TRANSFORMATEUR DE TENSION	KAU	RELAIS ARRET D'URGENCE	SV	COMMUTATEUR DE VOLTMETRE
QD	DISJONCTEUR	TC	TRANSFORMATEUR DE COURANT	UF	VARIATEUR	ECH	RESISTANCE CHAUFFANTE
QDG	DISJONCTEUR GENERAL	U	ONDULEUR, ALIMENTATION	UM	DEMARREUR	ECL	ECLAIRAGE
FP	PARAFODRE	KIC	INTER CREPUSCULAIRE	S	ORGANE DE COMMANDE	G	BATTERIE
FU	FUSIBLE	KIH	HORLOGE	H	VOYANT, SIRENE	P	INSTRUMENTATION
F	THERMIQUE	KTH	THERMOSTAT	PCH	COMPTEUR HORAIRE	X	PRISE DE COURANT, BORNIER
QF	SECTIONNEUR FUSIBLE	KM	CONTACTEUR	PA	AMPEREMETRE	E	MATERIELS AUTRES
PF	CONTROLEUR DE PHASE	KA	RELAIS	PV	VOLTMETRE	KTL	TELERUPTEUR

LETTER CODES FOR ITEMS DESIGNATION ON THE DRAWING

QI	SWITCH	PCPI	INSULATION CONTROLLER	KT	TEMPORIZES RELAY	SA	AMPEREMETER SWITCH
QIG	GENERAL SWITCH	TR	TENSION TRANSFORMER	KAU	EMERGENCY STOP RELAY	SV	VOLTMETER SWITCH
QD	BREAKER	TC	CURRENT TRANSFORMER	UF	VELOCITY VARIATOR	ECL	LIGHT
QDG	GENERAL BREAKER	U	INVERTER, SUPPLY	UM	MOTOR STARTER	ECH	HEATER
FP	LIGHTNING PROTECTOR	KIC	DIMMER	S	CONTROL UNIT	G	BATTERY
FU	FUSE	KIH	CLOCK	H	INDICATOR	P	INSTRUMENTATION
F	THERMAL RELAY	KTH	THERMOSTAT	PCH	TIMER	X	SOCKET, TERMINAL BLOCK
QF	DISCONNECTING SWITCH	KM	CONTACTOR	PA	AMPEREMETER	E	OTHER EQUIPMENTS
PF	PHASE CONTROLLER	KA	RELAY	PV	VOLTMETER	KTL	TELEBREAKER

COULEURS DE FILS

TRI 400V: <= 6 mm2 Noir Rouge Brun
> 6 mm2 Noir Bagué Noir Rouge Brun

NEUTRE: Bleu Clair

230VAC: Rouge avec Commun Bobines Blanc (*)

230VAC ONDULE: Neutre Bleu Clair Bagué Orange
Phase Noir Bagué Orange

110VAC: Noir avec Commun Bobines Blanc (*)

24VAC: Violet avec Commun Bobines Blanc (*)

24VDC: Bleu Foncé avec Commun Bobines Blanc (*)

48VAC: Violet avec Commun Bobines Blanc (*)

48VDC: Bleu Foncé avec Commun Bobines Blanc (*)

REPORTS: Orange

TERRE: Vert/Jaune

ANALOGIQUE: Une Paire + Brun - Blanc
Unifilaire Blanc

TENSION EXTERNE PERMANENTE INTER GENERAL OUVERT: Orange

ATTENTION

Si plusieurs tensions de télécommande, alors prendre uniquement le 230VAC avec Commun Bobines Blanc

(*) Si Télécommande

WIRE COLOR

TRI 400V: <= 6 mm2 Black Red Brown
> 6 mm2 Black with Ring Black Red Brown

NEUTRE: Light Blue

230VAC: Red with Spods Common White (*)

230VAC UPS: Neutre Light Blue with Ring Orange
Phase Black with Ring Orange
Black with Spods Common White (*)

110VAC: Black with Spods Common White (*)

24VAC: Purple with Spods Common White (*)

24VDC: Dark Bleu with Spods Common White (*)

48VAC: Purple with Spods Common White (*)

48VDC: Dark Bleu with Spods Common White (*)

REPORTS: Orange

GROUND: Green/Yellow

ANALOGICAL: One Pair + Brown - White
Unifilar White

PERMANENTLY EXTERNAL POWER GENERAL BREAKER OPEN: Orange

CAUTION

If There are Several Tensions of Command Then to take Only the 230VAC with Spods Common White

(*) If Command

TYPE DE RELAIS ET DE CONTACT DANS LE SCHEMA

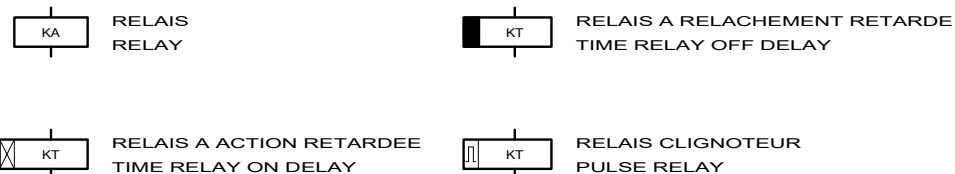

RELAY AND CONTACT TYPE IN THE DRAWING

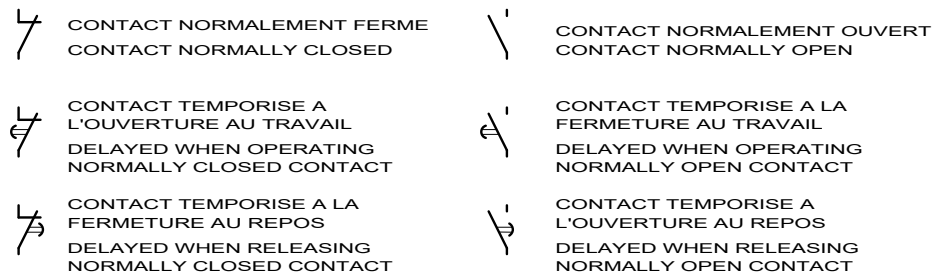

LE SCHEMA EST REPRESENTÉ HORS TENSION ET GENERATEUR HORS SERVICE

THE DRAWING IS SHOWN OUT OF VOLTAGE AND WITH GENERATOR OUT OF SERVICE



3, Rue Pierre Curie
91230 MONTGERON
Tél. : 01.69.52.47.00 - Fax : 01.69.52.47.01
e-mail : seguin@automatismes-seguin.fr
http://www.automatismes-seguin.fr

LEGENDE DU SCHEMA ELECTRIQUE

CLIENT ET NOM DU DOSSIER / CUSTOMER AND NAME OF FOLDER		INDICE / REVIEW
SAUR		0
Armoire De Supression Du Ruvet		
DESSINATEUR DRAWER	M.H.	FOLIO/SHEET 03/04
N° AFFAIRE N° PROJECT	180253	
IGE-XAO		VARZ SERVICE PACK 11-14-49-FI

CODE DU REPERAGE

LETTER CODE

1/ DES APPAREILS DANS LES ARMOIRES
APPARATUS IN THE CABINETS



EXEMPLE:KA RELAIS
EXAMPLE:KA RELAY

52 KA 01

N° D'ORDRE DANS LE FOLIO D'ORIGINE
ORDER NUMBER ON ORIGINAL SHEET

LETTRE DE REPERAGE
LETTER CODES FOR ITEM

N° DU FOLIO D'ORIGINE
ORIGINAL SHEET NUMBER

2/ DES FILS DE CABLAGE
WIRING

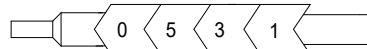

N° DU FOLIO D'ORIGINE
ORIGINAL SHEET NUMBER

N° DU FIL DANS LE FOLIO D'ORIGINE
NUMBER OF THE WIRE ON ORIGINAL SHEET

3/ REPORT DES CONTACTS DANS LE SCHEMA
CONTACT REPORT IN THE DRAWING

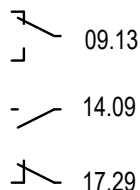

17.29

N° DE LA COLONNE OU EST UTILISE LE CONTACT
COLUMN NUMBER WHERE THE CONTACT IS USED

N° DU FOLIO OU EST UTILISE LE CONTACT
SHEET NUMBER WHERE THE CONTACT IS USED

4/ REPRESENTATION DES BORNES ET BORNIERES DANS LE SCHEMA
BINDINGS SCREWS VIEW IN THE DRAWING



N° D'ORDRE (SI NECESSAIRE)
ORDER NUMBER (IF NECESSARY)

NATURE DU BORNIER
NATURE OF TERMINAL BLOCK

A : ALIMENTATION
P : PUISSANCE
T : TELECOMMANDE
M : MESURE
R : REPORTS



LE SCHEMA EST REPRESENTE HORS TENSION ET GENERATEUR HORS SERVICE

THE DRAWING IS SHOWN OUT OF VOLTAGE AND WITH GENERATOR OUT OF SERVICE



3, Rue Pierre Curie
91230 MONTGERON
Tél. : 01.69.52.47.00 - Fax : 01.69.52.47.01
e-mail : seguin@automatismes-seguin.fr
http://www.automatismes-seguin.fr

LEGENDE DU SCHEMA ELECTRIQUE

CLIENT ET NOM DU DOSSIER / CUSTOMER AND NAME OF FOLDER		INDICE / REVIEW
SAUR		0
Armoire De Surpression Du Ruvet		
DESSINATEUR DRAWER	M.H.	FOLIO/SHEET 04/05
N° AFFAIRE N° PROJECT	180253	
IGE-XAO		VARZ SERVICE PACK.11-(A.49.F)

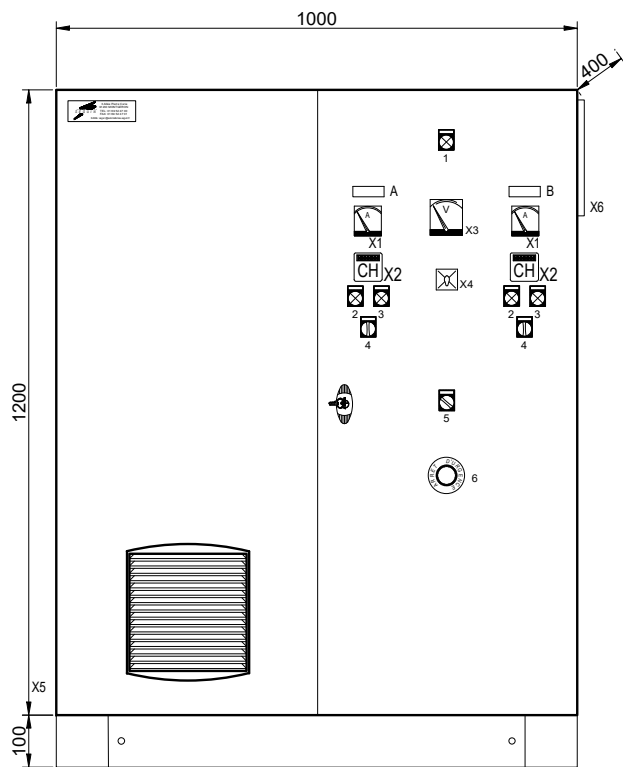

IMPLANTATION FACADE

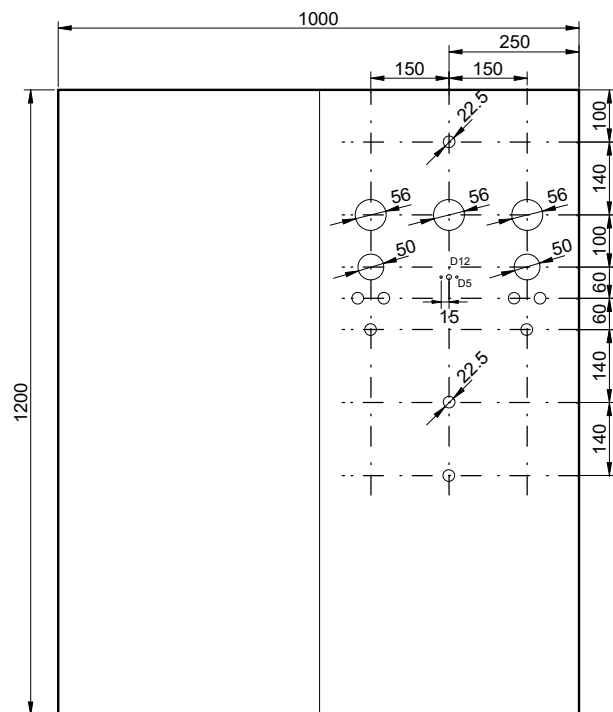

IMPLANTATION DECOUPE

ETIQUETTES SCHNEIDER

- 1 - PRESENCE TENSION
- 2 - MARCHÉ
- 3 - DEFAULT
- 4 - AUTO/0/MANU
- 5 - MODE DEGRADE
- 6 - ARRÊT D'URGENCE

ETIQUETTES 60x20

- A - POMPE 1
- B - POMPE 2

DIVERS

- X1 - AMPEREMETRE
- X2 - COMPTEUR HORAIRE
- X3 - VOLTMETRE
- X4 - COMMUTATEUR DE VOLTMETRE
- X5 - VENTILATEUR
- X6 - OUIE





3, Rue Pierre Curie
91230 MONTGERON
Tél. : 01.69.52.47.00 - Fax : 01.69.52.47.01
e-mail : seguin@automatismes-seguin.fr
http://www.automatismes-seguin.fr

IMPLANTATION EXTERNE

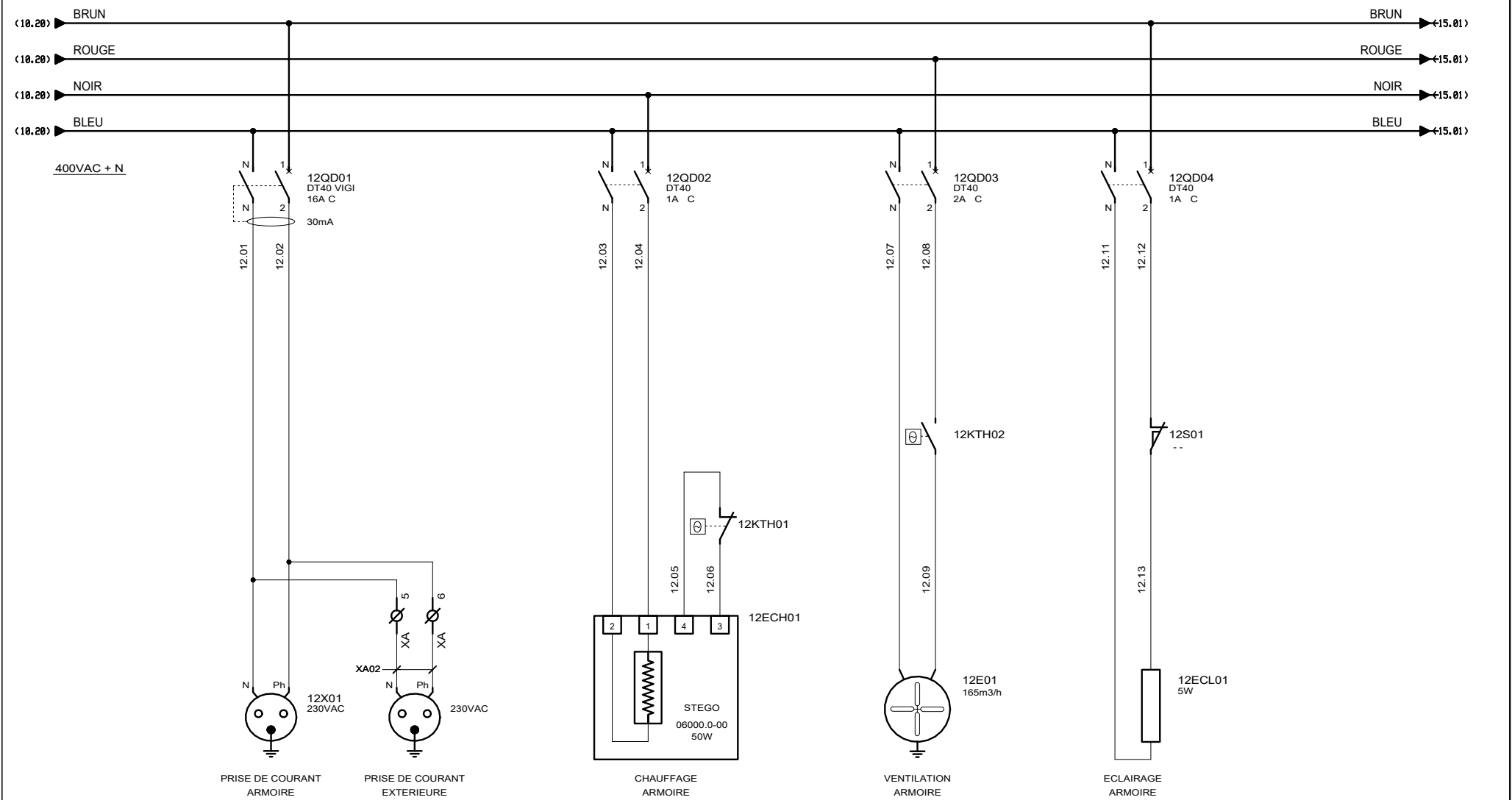
CLIENT ET NOM DU DOSSIER / CUSTOMER AND NAME OF FOLDER		INDICE / REVIEW
SAUR		0
Armoire De Surpression Du Ruvet		
DESSINATEUR DRAWER	M.H.	FOLIO/SHEET 05 / 10
N° AFFAIRE N° PROJECT	180253	
VARZ SERVICE PACK.11-(4.49.F)		

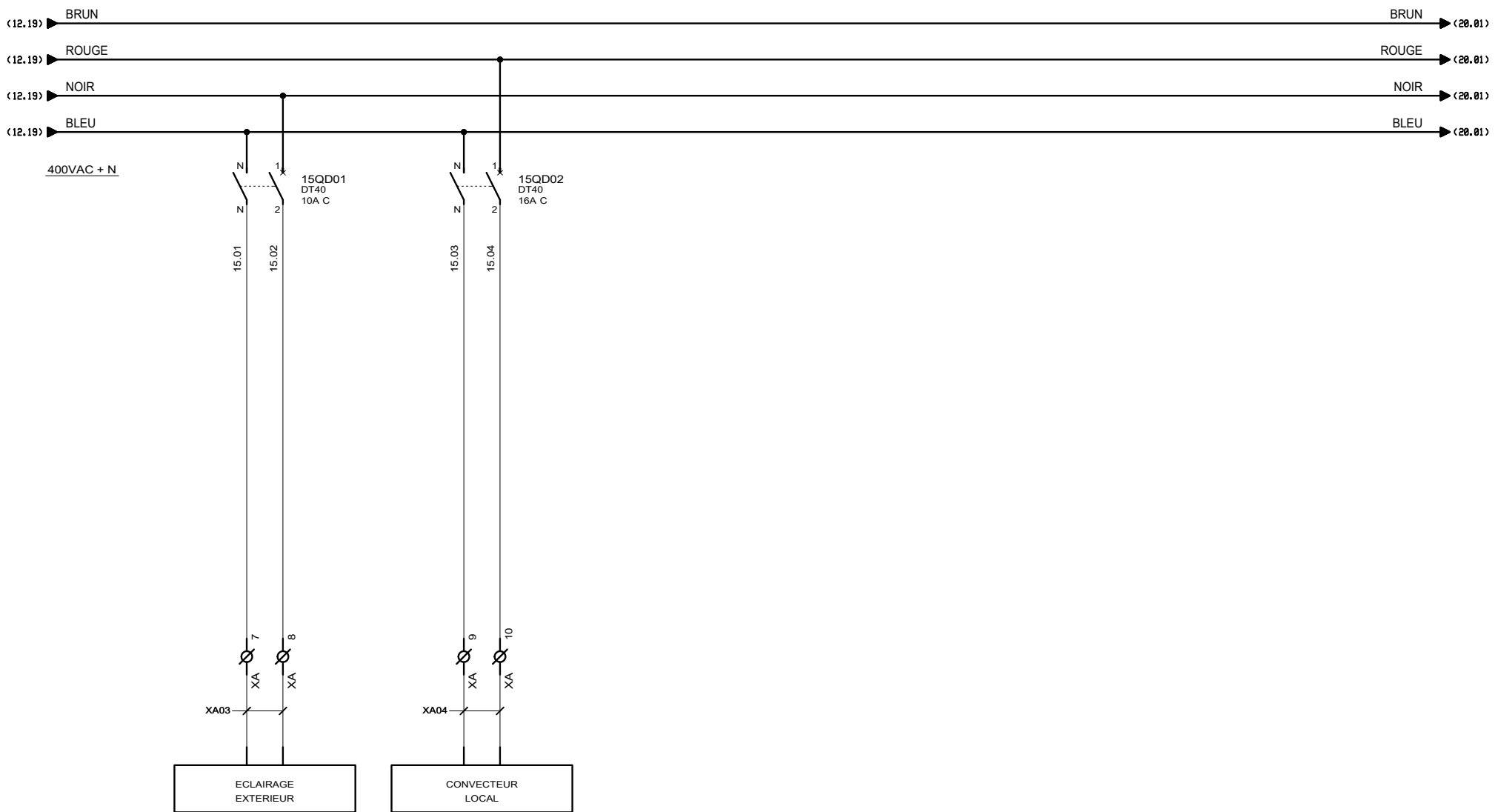





 3, Rue Pierre Curie
 91230 MONTGERON
 Tél. : 01.69.52.47.00 - Fax : 01.69.52.47.01
 e-mail : seguin@automatismes-seguin.fr
 http://www.automatismes-seguin.fr

DISTRIBUTION 400VAC + N

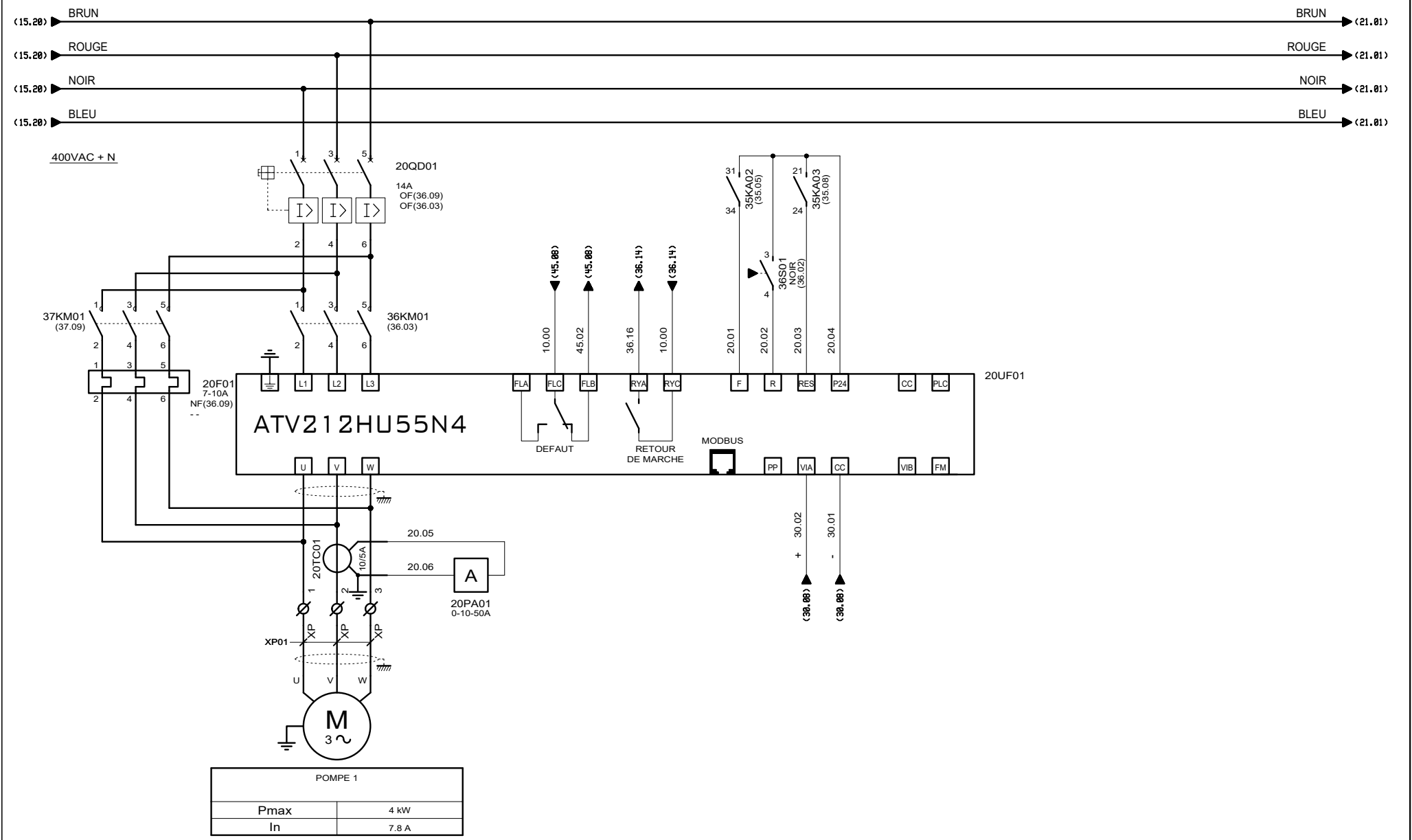
CLIENT ET NOM DU DOSSIER / CUSTOMER AND NAME OF FOLDER		INDICE / REVIEW
SAUR		1
Armoire De Surpression Du Ruvet		
DESSINATEUR DRAWER	M.H.	FOLIO/SHEET 15 / 20
N° AFFAIRE N° PROJECT	180253	
		IGE-XAO VARZ SERVICE PACK.11-(4.49.F)





AUTOMATISMES SEGUIN
Systeme Qualité

3, Rue Pierre Curie
91230 MONTGERON
Tél. : 01.69.52.47.00 - Fax : 01.69.52.47.01
e-mail : seguin@automatismes-seguin.fr
http://www.automatismes-seguin.fr

PUISSANCE POMPE 1

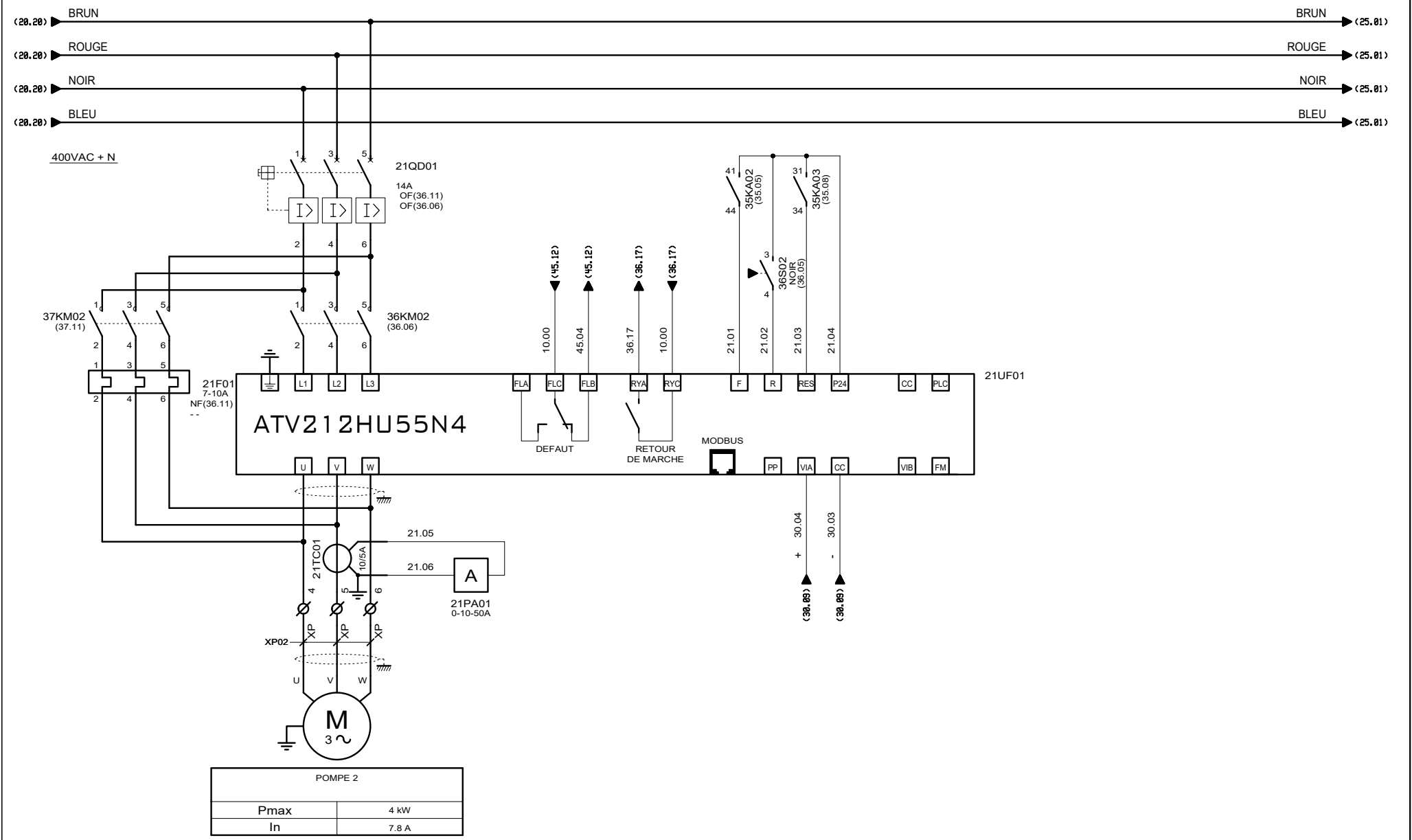
CLIENT ET NOM DU DOSSIER / CUSTOMER AND NAME OF FOLDER		INDICE / REVIEW
SAUR		0
Armoire De Surpression Du Ruvet		
DESSINATEUR DRAWER	M.H.	FOLIO/SHEET 20 / 21
N° AFFAIRE N° PROJECT	180253	
IGE XAO		VARZ SERVICE PACK.11-(4.49.F)





 3, Rue Pierre Curie
 91230 MONTGERON
 Tél. : 01.69.52.47.00 - Fax : 01.69.52.47.01
 e-mail : seguin@automatismes-seguin.fr
 http://www.automatismes-seguin.fr

PUISSANCE POMPE 2

CLIENT ET NOM DU DOSSIER / CUSTOMER AND NAME OF FOLDER			INDICE / REVIEW
SAUR			0
Armoire De Surpression Du Ruvet			
DESSINATEUR DRAWER	M.H.	FOLIO/SHEET	21 / 25
N° AFFAIRE N° PROJECT	180253		

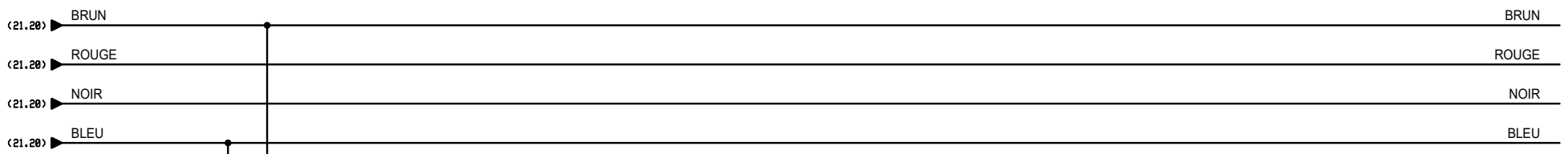



SOFREL S550 (VUE DE DESSOUS)

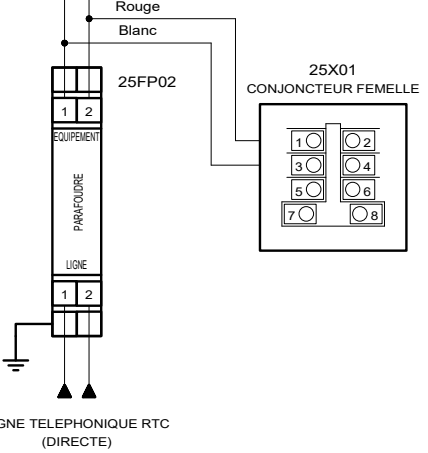
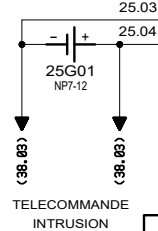
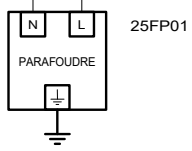
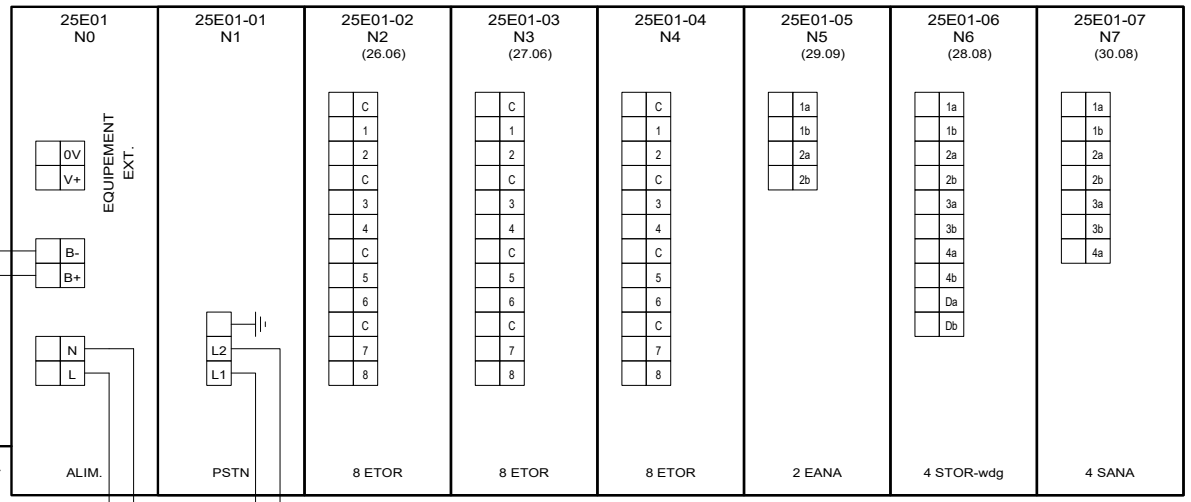

ALIMENTATION SOFREL S550

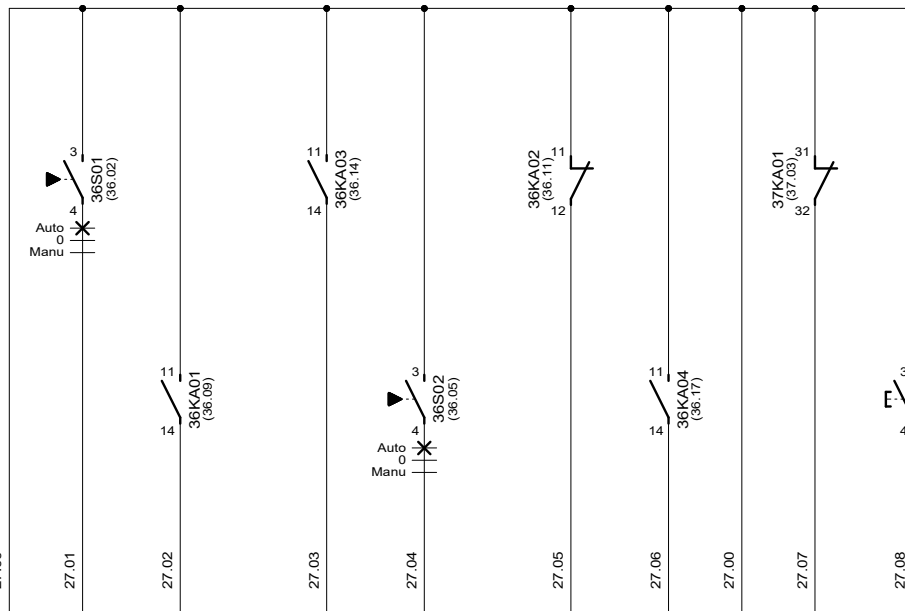

BORNIER	C	1	2	C	3	4	C	5	6	C	7	8
VOIES		1	2		3	4		5	6		7	8
DESIGNATION		AUTO POMPE 1 (COMMUN VOIES 1 ET 2)	DEFAULT POMPE 1		RETOUR DE MARCHE POMPE 1 (COMMUN VOIES 3 ET 4)	AUTO POMPE 2		DEFAULT POMPE 2 (COMMUN VOIES 5 ET 6)	RETOUR DE MARCHE POMPE 2		COMMUTATEUR EN MODE AUTO / DEGRADE (COMMUN VOIES 7 ET 8)	BOUTON REARMEMENT DEFAULT
CARTE 8 ETOR SOFREL S550												

25E01-03
(25.10)



3, Rue Pierre Curie
91230 MONTGERON
Tél. : 01.69.52.47.00 - Fax : 01.69.52.47.01
e-mail : seguin@automatismes-seguin.fr
http://www.automatismes-seguin.fr

CARTE 8 ENTrees TOR EMPLACEMENT 3

CLIENT ET NOM DU DOSSIER / CUSTOMER AND NAME OF FOLDER		INDICE / REVIEW
SAUR Armoire De Surpression Du Ruvet		1
DESSINATEUR DRAWER	M.H.	FOLIO/SHEET 27 / 28
N° AFFAIRE N° PROJECT	180253	
		VARD SERVICE PACK.11-(4.49.F)

CARTE 4 STOR-wdg SOFREL S550										
DESIGNATION	COMMANDE POMPE 1		COMMANDE POMPE 2						CHIEN DE GARDE	
	1		2		3		4		5	
	1a	1b	2a	2b	3a	3b	4a	4b	Da	Db

25E01-06
(25.14)

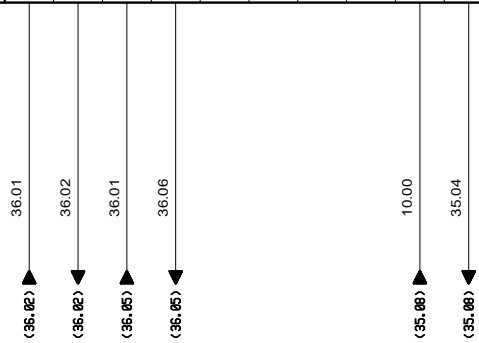

3, Rue Pierre Curie
91230 MONTGERON
Tél. : 01.69.52.47.00 - Fax : 01.69.52.47.01
e-mail : seguin@automatismes-seguin.fr
http://www.automatismes-seguin.fr

**CARTE 4 SORTIES TOR
EMPLACEMENT 6**

CLIENT ET NOM DU DOSSIER / CUSTOMER AND NAME OF FOLDER			INDICE / REVIEW
SAUR			0
Armoire De Surpression Du Ruvet			 <small>VARD SERVICE PACK.11-(4.49.F)</small>
DESSINATEUR DRAWER	M.H.	FOLIO/SHEET	
N° AFFAIRE N° PROJECT	180253	28 / 29	

RACCORDEMENT :
POUR CAPTEUR AUTONOME

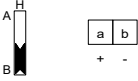

RACCORDEMENT :
POUR CAPTEUR TELEALIMENTE

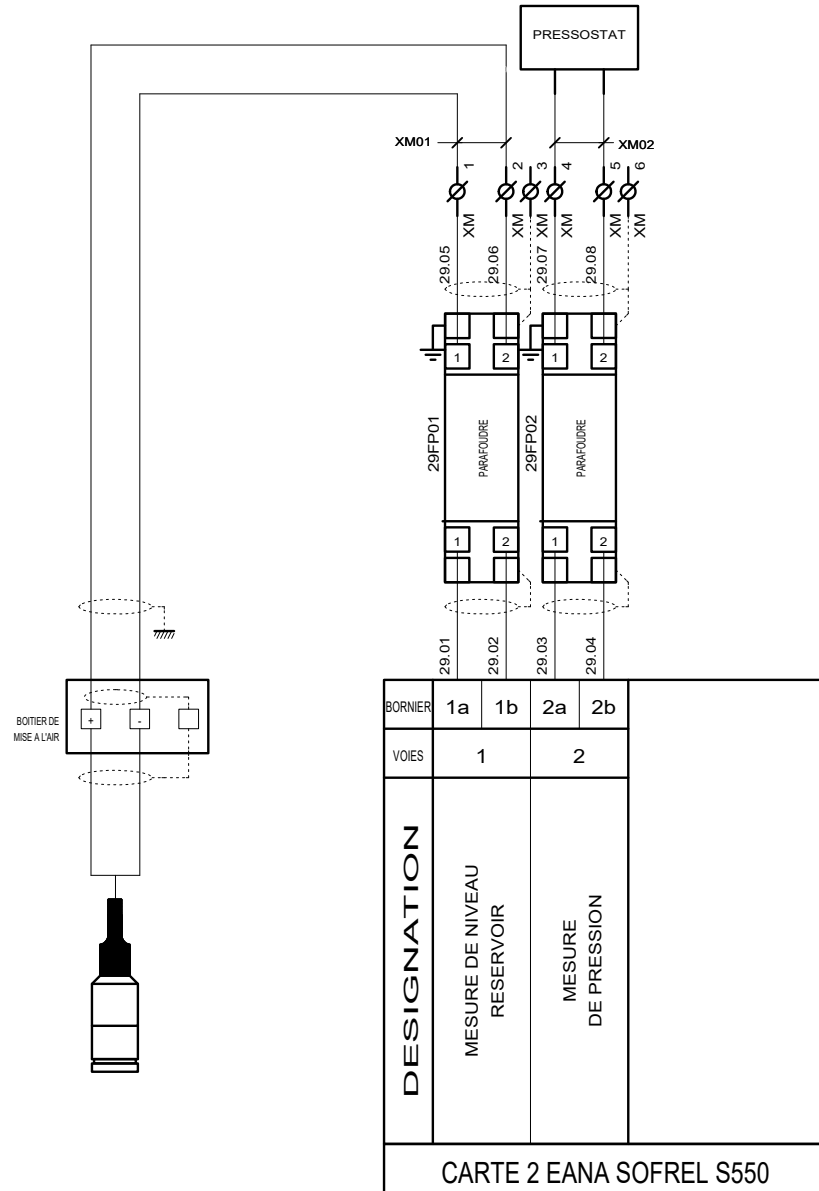
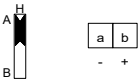

25E01-05
(25.13)



3, Rue Pierre Curie
91230 MONTGERON
Tél. : 01.69.52.47.00 - Fax : 01.69.52.47.01
e-mail : seguin@automatismes-seguin.fr
http://www.automatismes-seguin.fr

CARTE 2 ENTREES ANALOGIQUES EMPLACEMENT 5

CLIENT ET NOM DU DOSSIER / CUSTOMER AND NAME OF FOLDER		INDICE / REVIEW
SAUR Armoire De Surpression Du Ruvet		0
DESSINATEUR DRAWER	M.H.	FOLIO/SHEET 29 / 30
N° AFFAIRE N° PROJECT	180253	
		 <small>VARZ SERVICE PACK.11-(A.49.F)</small>

CARTE 4 SANA SOFREL S550								
DESIGNATION	CONSIGNE VARIATEUR POMPE 1		CONSIGNE VARIATEUR POMPE 2					
	1		2		3		4	
VOIES	1		2		3		4	
POLARITE	+	-	+	-	+	-	+	-
BORNIER	1a	1b	2a	2b	3a	3b	4a	4b

25E01-07
(25.16)

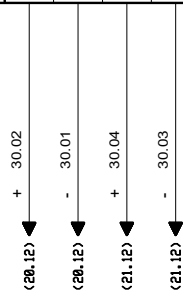

3, Rue Pierre Curie
91230 MONTGERON
Tél. : 01.69.52.47.00 - Fax : 01.69.52.47.01
e-mail : seguin@automatismes-seguin.fr
http://www.automatismes-seguin.fr

**CARTE 4 SORTIES ANALOGIQUES
EMPLACEMENT 7**

CLIENT ET NOM DU DOSSIER / CUSTOMER AND NAME OF FOLDER		INDICE / REVIEW
SAUR		0
Armoire De Surpression Du Ruvet		
DESSINATEUR DRAWER	M.H.	FOLIO/SHEET 30 / 35
N° AFFAIRE N° PROJECT	180253	
		IGE XAO VARZ SERVICE PACK.11-(A.49.F)

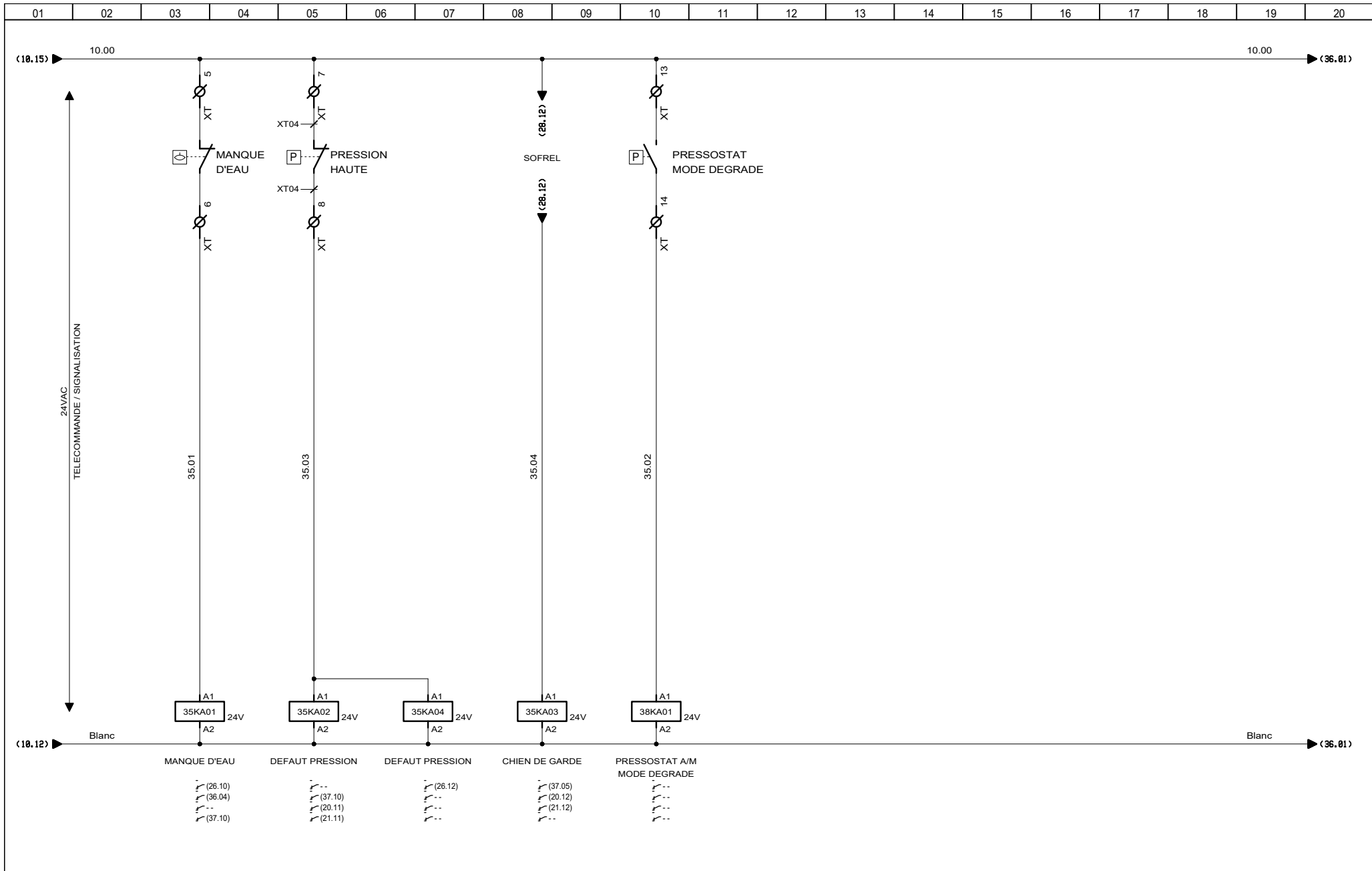

3, Rue Pierre Curie
91230 MONTGERON
Tél. : 01.69.52.47.00 - Fax : 01.69.52.47.01
e-mail : seguin@automatismes-seguin.fr
http://www.automatismes-seguin.fr

RELAYAGE DEFAUTS

CLIENT ET NOM DU DOSSIER / CUSTOMER AND NAME OF FOLDER		INDICE / REVIEW
SAUR		1
Armoire De Surpression Du Ruvet		
DESSINATEUR DRAWER	M.H.	IGE XAO
N° AFFAIRE N° PROJECT	180253	FOLIO/SHEET 35 / 36
VARZ SERVICE PACK.11-(A.49.F)		

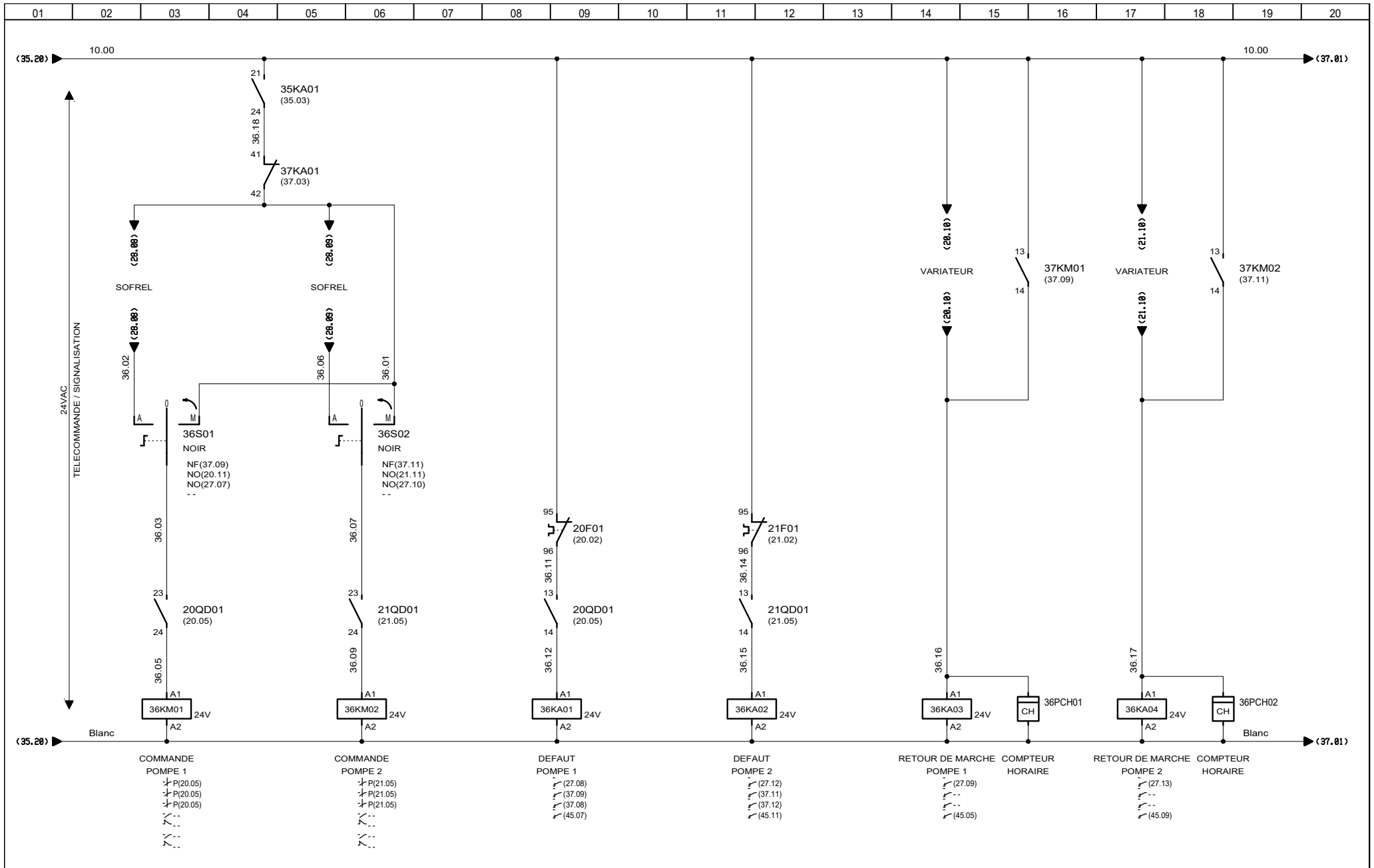

3, Rue Pierre Curie
 91230 MONTGERON
 Tél. : 01.69.52.47.00 - Fax : 01.69.52.47.01
 e-mail : seguin@automatismes-seguin.fr
 http://www.automatismes-seguin.fr

RELAYAGE POMPES

CLIENT ET NOM DU DOSSIER / CUSTOMER AND NAME OF FOLDER		INDICE / REVIEW
SAUR		1
Armoire De Surpression Du Ruvet		
DESSINATEUR / DRAWER	M.H.	FOLIO/SHEET 36 / 37
N° AFFAIRE / N° PROJECT	180253	
VARZ SERVICE PACK.11-(4.49.F)		

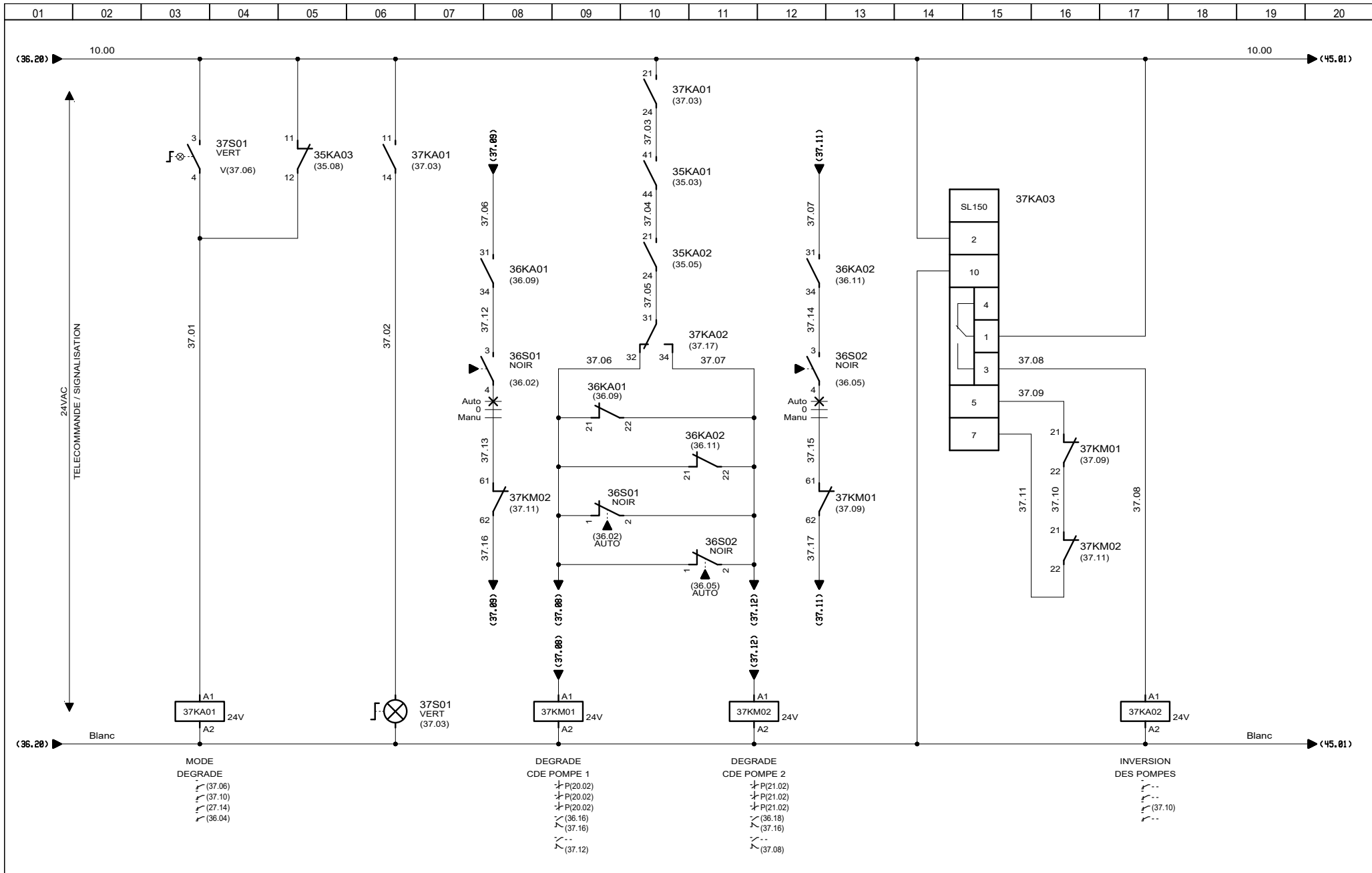

3, Rue Pierre Curie
91230 MONTGERON
Tél. : 01.69.52.47.00 - Fax : 01.69.52.47.01
e-mail : seguin@automatismes-seguin.fr
http://www.automatismes-seguin.fr

TELECOMMANDE DEGRADE

CLIENT ET NOM DU DOSSIER / CUSTOMER AND NAME OF FOLDER		INDICE / REVIEW
SAUR		0
Armoire De Surpression Du Ruvet		
DESSINATEUR DRAWER	M.H.	FOLIO/SHEET 37/38
N° AFFAIRE N° PROJECT	180253	
VARZ SERVICE PACK.11-(A.49.F)		

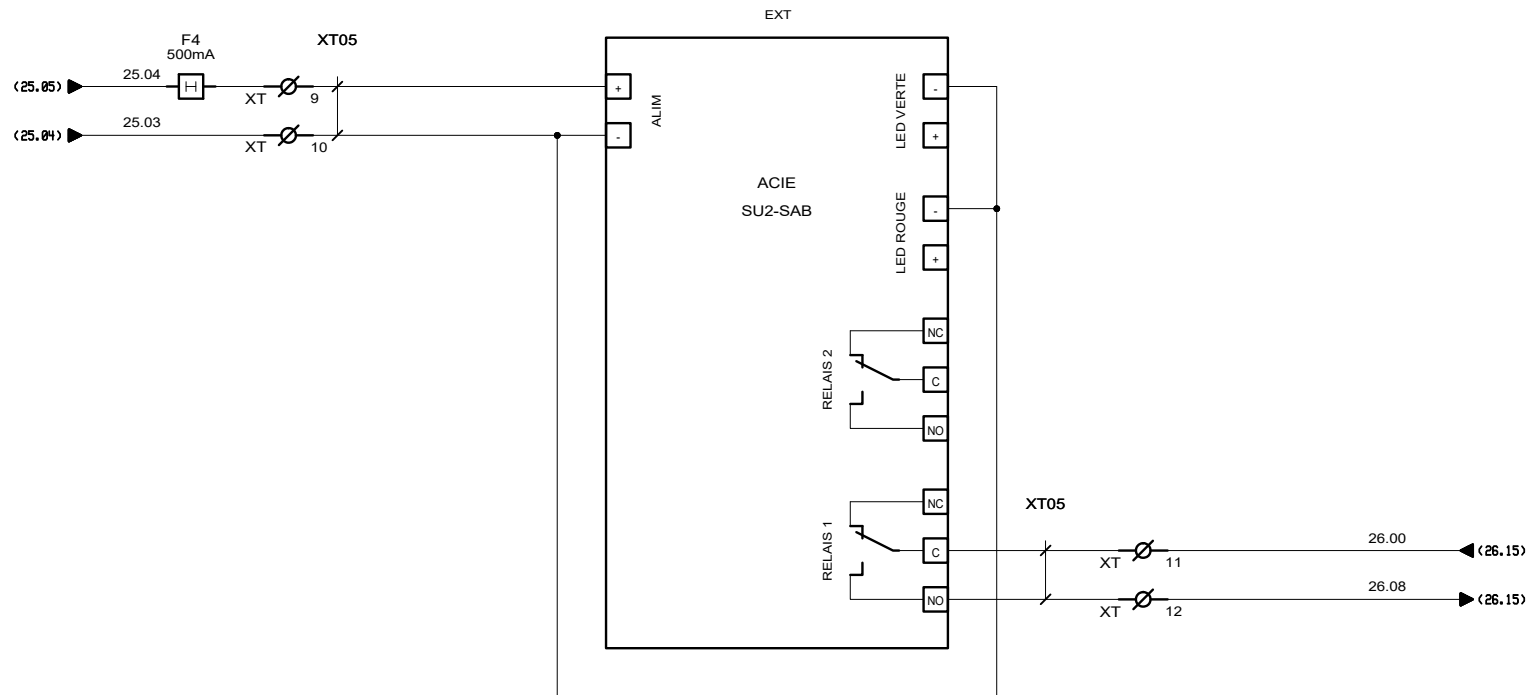

CLAVIER CODE

TELECOMMANDE INTRUSION

CLIENT ET NOM DU DOSSIER / CUSTOMER AND NAME OF FOLDER		INDICE / REVIEW
SAUR		1
Armoire De Surpression Du Ruvet		
DESSINATEUR / DRAWER	M.H.	FOLIO/SHEET 38 / 45
N° AFFAIRE / N° PROJECT	180253	
		<small>VARD SERVICE PACK.11-(4.49.F)</small>

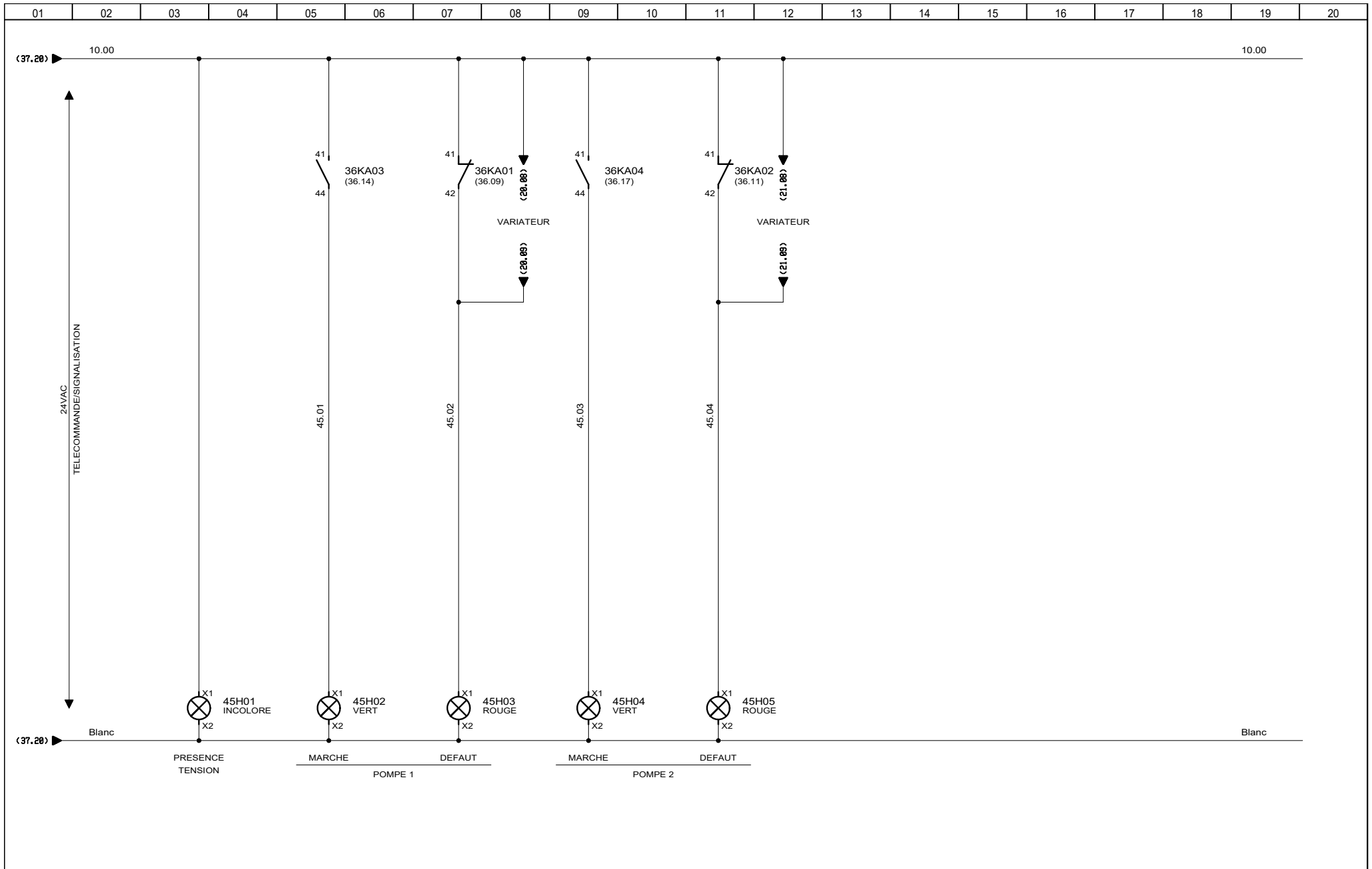

3, Rue Pierre Curie
91230 MONTGERON
Tél. : 01.69.52.47.00 - Fax : 01.69.52.47.01
e-mail : seguin@automatismes-seguin.fr
http://www.automatismes-seguin.fr

SIGNALISATION

CLIENT ET NOM DU DOSSIER / CUSTOMER AND NAME OF FOLDER		INDICE / REVIEW
SAUR		1
Armoire De Surpression Du Ruvet		
DESSINATEUR DRAWER	M.H.	FOLIO/SHEET 45 / 50
N° AFFAIRE N° PROJECT	180253	
		IGE XAO VARZ SERVICE PACK.11-(A.49.F)

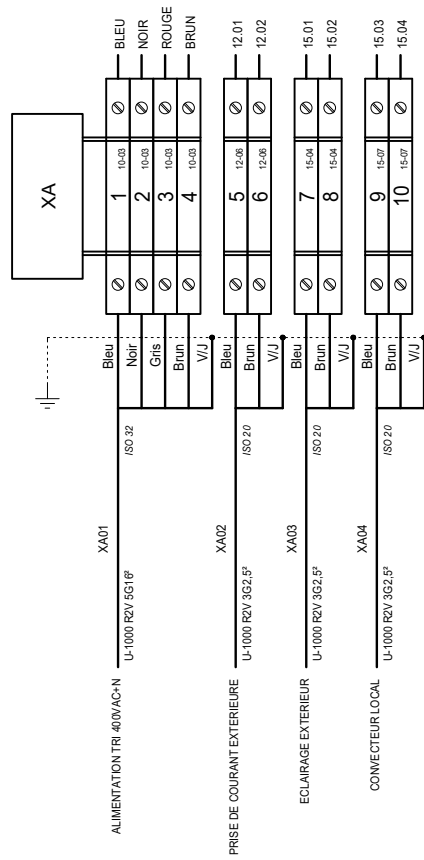

3, Rue Pierre Curie
91230 MONTGERON
Tél. : 01.69.52.47.00 - Fax : 01.69.52.47.01
e-mail : seguin@automatismes-seguin.fr
<http://www.automatismes-seguin.fr>

BORNIER XA ALIMENTATION

CLIENT ET NOM DU DOSSIER / CUSTOMER AND NAME OF FOLDER		INDICE / REVIEW
SAUR		1
Armoire De Surpression Du Ruvet		
DESSINATEUR DRAWER	M.H.	FOLIO/SHEET 50 / 51
N° AFFAIRE N° PROJECT	180253	
IGE XAO		VARD SERVICE PACK.11-(4.49.F)

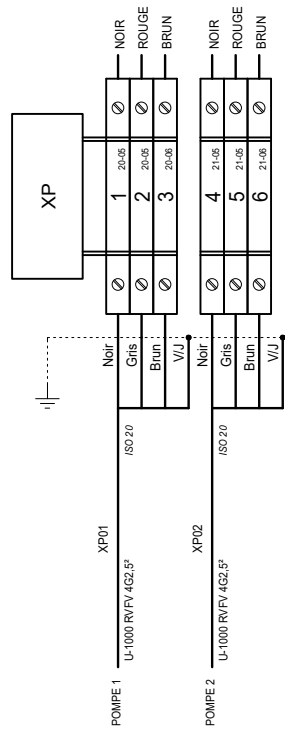

3, Rue Pierre Curie
91230 MONTGERON
Tél. : 01.69.52.47.00 - Fax : 01.69.52.47.01
e-mail : seguin@automatismes-seguin.fr
http://www.automatismes-seguin.fr

BORNIER XP PUISSANCE

CLIENT ET NOM DU DOSSIER / CUSTOMER AND NAME OF FOLDER		INDICE / REVIEW
SAUR		0
Armoire De Surpression Du Ruvet		
DESSINATEUR DRAWER	M.H.	FOLIO/SHEET 51/52
N° AFFAIRE N° PROJECT	180253	
		IGE XAO VARZ SERVICE PACK.11-(4.49.F)

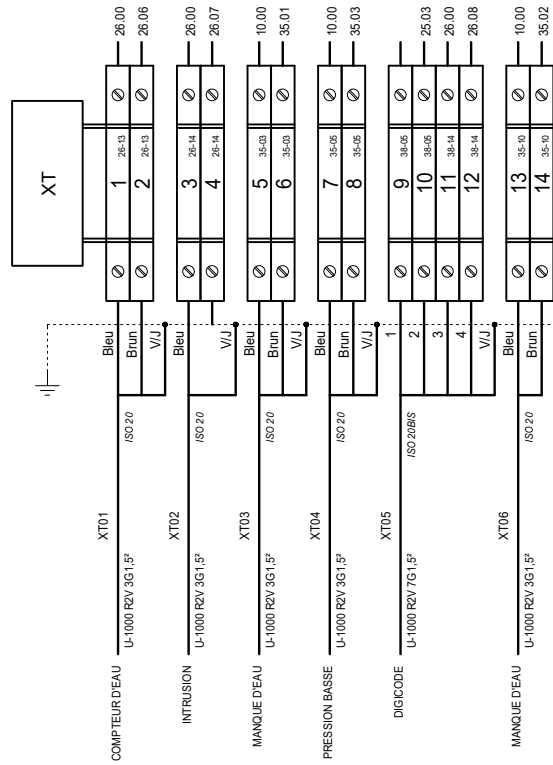

3, Rue Pierre Curie
 91230 MONTGERON
 Tél. : 01.69.52.47.00 - Fax : 01.69.52.47.01
 e-mail : seguin@automatismes-seguin.fr
 http://www.automatismes-seguin.fr

BORNIER XT TELECOMMANDE

CLIENT ET NOM DU DOSSIER / CUSTOMER AND NAME OF FOLDER		INDICE / REVIEW
SAUR		1
Armoire De Surpression Du Ruvet		
DESSINATEUR DRAWER	M.H.	FOLIO/SHEET 52 / 53
N° AFFAIRE N° PROJECT	180253	
		IGE XAO VARZ SERVICE PACK.11-(A.49.F)

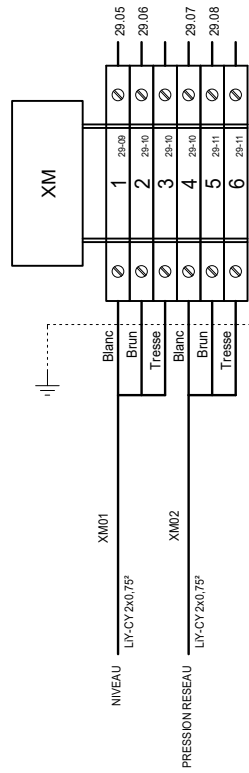

BORNIER XM MESURE

CLIENT ET NOM DU DOSSIER / CUSTOMER AND NAME OF FOLDER		INDICE / REVIEW
SAUR		0
Armoire De Surpression Du Ruvet		
DESSINATEUR DRAWER	M.H.	FOLIO/SHEET 53/60
N° AFFAIRE N° PROJECT	180253	
		 <small>VAR2 SERVICE PACK.11-(4.49.F)</small>

REPERE	DESIGNATION	REFERENCE	MARQUE	QTE
TOLERIE	COFFRET UNIVERSEL AVEC PORTE PLEINE SANS CHASSIS 1200x1000x400, IP55, RAL7035	NSYS3D121040D	SCHNEIDER ELECTRIC	1
	POIGNEE A CLE 2433A PR COFF.3D	NSYAEDL2433S3D	SCHNEIDER ELECTRIC	1
	PORTE SCHEMA A4	NSYDPA4	SCHNEIDER ELECTRIC	1
	CHASSIS SYMETRIQUE DIN POUR COFFRET H800xL1000	NSYSDR100A	SCHNEIDER ELECTRIC	1
	SOCLE FRONTAL SF/SM 100x1000	NSYSPF10100	SCHNEIDER ELECTRIC	1
	JEU DE 2 TRAPPES LATERALES POUR ARMOIRE P400	NSYSPS4100	SCHNEIDER ELECTRIC	1
	JEU 2 PL PR SOCLE SD 400x100	NSYSPS4100SD	SCHNEIDER ELECTRIC	1
10E01	REPARTITEUR TETRAPOLAIRE TD 40 A, 12 CONNEXIONS	563740	ERICO	1
10E02	BARRETTE DE COUPURE BASSE, PLATINE PLASTIQUE 95x20mm, L = 125mm	034389	LEGRAND	1
10KA01	RELAIS INDUSTRIEL EMBROCHABLE, MONOSTABLE, 4INV, 24VAC + EMBASE + ETRIER	2903686 + 2900934 + 2900954	PHOENIX CONTACT	1
10PF01	RELAIS DE CONTROLE TRIPHASE POUR L'ORDRE ET LA PERTE DE PHASES, 208-480VAC, 1INV	DPA51CM44	CARLO GAVAZZI	1
10PV01	VOLTMETRE ROTEX R72A90-V, ALTERNATIF 0-500V DIRECT DEV 90D	192G2107	SOCOMEK	1
	2 CAPUCHONS	192Z1016	SOCOMEK	1
10QD01	DISJONCTEUR DT40 1P+N 1A 6kA, COURBE C	A9N21019	SCHNEIDER ELECTRIC	1
10QD02	DISJONCTEUR IC60N 3P 1A, 440VAC/25kA, 133VDC/6kA, COURBE C	A9F74301	SCHNEIDER ELECTRIC	1
10QD03	DISJONCTEUR IC60N 2P 2A, 440VAC/25kA, 133VDC/6kA, COURBE C	A9F74202	SCHNEIDER ELECTRIC	1
10QD04	DISJONCTEUR DT40 1P+N 4A 6kA, COURBE C	A9N21022	SCHNEIDER ELECTRIC	1
10QD05	DISJONCTEUR IC60N 4P 1A, 440VAC/25kA, 250VDC/6kA, COURBE C	A9F74401	SCHNEIDER ELECTRIC	1
10QIG01	INTERRUPTEUR DIFFERENTIEL iID TYPE AC 415VAC 4P 40A 300mA	A9R14440	SCHNEIDER ELECTRIC	1
	DECLENCHEUR A EMISSION DE TENSION MX+OF 100-415V 50-60Hz / 110-130VDC	A9N26946	SCHNEIDER ELECTRIC	1
10S01	TETE ARRET D'URGENCE	ZB4BS844	SCHNEIDER ELECTRIC	1
	CORPS CONTACT NO	ZB4BZ101	SCHNEIDER ELECTRIC	1
10SV01	COMMUTATEUR VOLT 7POS VIS	192K0013	SOCOMEK	1
10TR01	TRANSFORMATEUR DE COMMANDE ET DE SIGNALISATION MONOPHASEE 230-400V/24-48V, 100VA	044233	LEGRAND	1
12E01	VENTILATEUR A FILTRE 223x223 165m3/h, 230VAC, RAL7035	NSYCVF165M230PF	SCHNEIDER ELECTRIC	1
	GRILLE DE SORTIE POUR VENTILATEUR 223x223, RAL7032	NSYCAG223LPC	SCHNEIDER ELECTRIC	1
12ECH01	RESISTANCE CHAUFFANTE PTC CS 060, 120-240V AC/DC, 50W	06000-0-00	STEGO	1
12ECL01	LAMPE LED 5W 220V 50-60Hz 500lm	NSYLAM75LD1	SCHNEIDER ELECTRIC	1
12KTH01	PETIT THERMOSTAT KTO 011, 1NF, 0..60°C	01146-9-00	STEGO	1
12KTH02	PETIT THERMOSTAT KTS 011, 1NO, 0..60°C	01147-9-00	STEGO	1
12QD01	DISJONCTEUR DT40 VIGI 1P+N CLASSE AC 16A 30mA COURBE C	A9N21444	SCHNEIDER ELECTRIC	1
12QD02	DISJONCTEUR DT40 1P+N 1A 6kA, COURBE C	A9N21019	SCHNEIDER ELECTRIC	1
12QD03	DISJONCTEUR DT40 1P+N 2A 6kA, COURBE C	A9N21020	SCHNEIDER ELECTRIC	1
12QD04	DISJONCTEUR DT40 1P+N 1A 6kA, COURBE C	A9N21019	SCHNEIDER ELECTRIC	1
12S01	CONTACT DE PORTE	NSYINLCRN	SCHNEIDER ELECTRIC	1
12X01	PRISE DE COURANT 2P+T 10/16A, 250VAC A ECLIPS	004280	LEGRAND	1
15QD01	DISJONCTEUR DT40 1P+N 10A 6kA COURBE C	A9N21024	SCHNEIDER ELECTRIC	1
15QD02	DISJONCTEUR DT40 1P+N 16A 6kA, COURBE C	A9N21025	SCHNEIDER ELECTRIC	1
20F01	RELAIS DE PROTECTION THERMIQUE 7-10A	LRD14	SCHNEIDER ELECTRIC	1
20PA01	AMPEREMETRE ROTEX R72A90-A, 0-10A-50A/5A DEV. 90D	192D3301	SOCOMEK	1
	2 CAPUCHONS	192Z1016	SOCOMEK	1
20QD01	DISJONCTEUR MOTEUR MAGNETIQUE 14A	GV2L16	SCHNEIDER ELECTRIC	1
	ADDITIF FRONTAL F+F	GVAE20	SCHNEIDER ELECTRIC	1
20TC01	TRANSFORMATEUR DE COURANT A PRIMAIRE BOBINE 10/5A	192T0510	SOCOMEK	1
20UF01	VARIATEUR DE VITESSE ATV 212 POUR MOTEUR 5.5kW, 380...480V TRI	ATV212HU55N4	SCHNEIDER ELECTRIC	1
21F01	RELAIS DE PROTECTION THERMIQUE 7-10A	LRD14	SCHNEIDER ELECTRIC	1
21PA01	AMPEREMETRE ROTEX R72A90-A, 0-10A-50A/5A DEV. 90D	192D3301	SOCOMEK	1



3, Rue Pierre Curie
91230 MONTGERON
Tél. : 01.69.52.47.00 - Fax : 01.69.52.47.01
e-mail : seguin@automatismes-seguin.fr
http://www.automatismes-seguin.fr

NOMENCLATURE

CLIENT ET NOM DU DOSSIER / CUSTOMER AND NAME OF FOLDER		INDICE / REVIEW
SAUR		1
Armoire De Surpression Du Ruvet		
DESSINATEUR DRAWER	M.H.	FOLIO/SHEET 60 / 61
N° AFFAIRE N° PROJECT	180253	
		IGE XAO VARZ SERVICE PACK 11-14-49-FI

REPERE	DESIGNATION	REFERENCE	MARQUE	QTE
	2 CAPUCHONS	192Z1016	SOCOMEK	1
21QD01	DISJONCTEUR MOTEUR MAGNETIQUE 14A	GV2L16	SCHNEIDER ELECTRIC	1
	ADDITIF FRONTAL F+F	GVAE20	SCHNEIDER ELECTRIC	1
21TC01	TRANSFORMATEUR DE COURANT A PRIMAIRE BOBINE 10/5A	192T0510	SOCOMEK	1
21UF01	VARIATEUR DE VITESSE ATV 212 POUR MOTEUR 5.5kW, 380...480V TRI	ATV212HU55N4	SCHNEIDER ELECTRIC	1
25E01	RACK S550 8 EMBLEMENTS AVEC ALIM SECTEUR 230VAC	T9950A100	SOFREL	1
25E01-01	MODULE DE COMMUNICATION PSTN (RTC) 33.600 bps	V5900510	SOFREL	1
25E01-02	MODULE D'ENTREES, 8E TOR	V5900210	SOFREL	1
25E01-03	MODULE D'ENTREES, 8E TOR	V5900210	SOFREL	1
25E01-04	MODULE D'ENTREES, 8E TOR	V5900210	SOFREL	1
25E01-05	MODULE D'ENTREES, 2E ANA MULTISTANDARD	V5900260	SOFREL	1
25E01-06	MODULE DE SORTIES, 4S TOR 1S TOR WDG 50V 1A	V5900310	SOFREL	1
25E01-07	MODULE DE SORTIES, 4S ANA 0/4-20mA 0-10V	V5900350	SOFREL	1
25FP01	PROTECTION SECTEUR 230V, 5kA, Up=1.2kV	T5300011	SOFREL	1
25FP02	PROTECTION RTC	T5300012	SOFREL	1
25G01	BATTERIE 12V, 7Ah	NP7-12	YUASA	1
25QD01	DISJONCTEUR DT40 1P+N 4A 6kA, COURBE C	A9N21022	SCHNEIDER ELECTRIC	1
25X01	PRISE TELEPHONIQUE SAILLIE - 8 CONTACTS	051219	LEGRAND	1
26S01	TETE BOUTON TOURNANT 2 POSITIONS	ZB4BD2	SCHNEIDER ELECTRIC	1
	CORPS CONTACT NF	ZB4BZ102	SCHNEIDER ELECTRIC	1
26S02	TETE BOUTON POUSSOIR NOIR	ZB4BA2	SCHNEIDER ELECTRIC	1
	CORPS CONTACT NF	ZB4BZ102	SCHNEIDER ELECTRIC	1
27S01	TETE BOUTON POUSSOIR BLEU	ZB4BA6	SCHNEIDER ELECTRIC	1
	CORPS CONTACT NF	ZB4BZ102	SCHNEIDER ELECTRIC	1
29FP01	PROTECTION AI 4-20mA	T5300014	SOFREL	1
29FP02	PROTECTION AI 4-20mA	T5300014	SOFREL	1
35KA01	RELAIS INDUSTRIEL EMBROCHABLE, MONOSTABLE, 4INV, 24VAC + EMBASE + ETRIER	2903686 + 2900934 + 2900954	PHOENIX CONTACT	1
35KA02	RELAIS INDUSTRIEL EMBROCHABLE, MONOSTABLE, 4INV, 24VAC + EMBASE + ETRIER	2903686 + 2900934 + 2900954	PHOENIX CONTACT	1
35KA03	RELAIS INDUSTRIEL EMBROCHABLE, MONOSTABLE, 4INV, 24VAC + EMBASE + ETRIER	2903686 + 2900934 + 2900954	PHOENIX CONTACT	1
35KA04	RELAIS INDUSTRIEL EMBROCHABLE, MONOSTABLE, 4INV, 24VAC + EMBASE + ETRIER	2903686 + 2900934 + 2900954	PHOENIX CONTACT	1
38KA01	RELAIS INDUSTRIEL EMBROCHABLE, MONOSTABLE, 4INV, 24VAC + EMBASE + ETRIER	2903686 + 2900934 + 2900954	PHOENIX CONTACT	1
36KA01	RELAIS INDUSTRIEL EMBROCHABLE, MONOSTABLE, 4INV, 24VAC + EMBASE + ETRIER	2903686 + 2900934 + 2900954	PHOENIX CONTACT	1
36KA02	RELAIS INDUSTRIEL EMBROCHABLE, MONOSTABLE, 4INV, 24VAC + EMBASE + ETRIER	2903686 + 2900934 + 2900954	PHOENIX CONTACT	1
36KA03	RELAIS INDUSTRIEL EMBROCHABLE, MONOSTABLE, 4INV, 24VAC + EMBASE + ETRIER	2903686 + 2900934 + 2900954	PHOENIX CONTACT	1
36KA04	RELAIS INDUSTRIEL EMBROCHABLE, MONOSTABLE, 4INV, 24VAC + EMBASE + ETRIER	2903686 + 2900934 + 2900954	PHOENIX CONTACT	1
36KM01	CONTACTEUR DE PUISSANCE 9A 1NO+1NF 24V 50/60Hz	LC1D09B7	SCHNEIDER ELECTRIC	1
	BLOC DE CONTACTS AUXILIAIRES 1NO+1NF FRONTAL	LADN11	SCHNEIDER ELECTRIC	1
36KM02	CONTACTEUR DE PUISSANCE 9A 1NO+1NF 24V 50/60Hz	LC1D09B7	SCHNEIDER ELECTRIC	1
	BLOC DE CONTACTS AUXILIAIRES 1NO+1NF FRONTAL	LADN11	SCHNEIDER ELECTRIC	1
36PCH01	COMPTEUR HORAIRE TOTALISATEUR 10...30V, 50Hz	3220401071	KUBLER	1
	CADRE POUR COMPTEUR DIN H57	BT008171	KUBLER	1
36PCH02	COMPTEUR HORAIRE TOTALISATEUR 10...30V, 50Hz	3220401071	KUBLER	1
	CADRE POUR COMPTEUR DIN H57	BT008171	KUBLER	1
36S01	TETE BOUTON TOURNANT 3 POSITIONS, RAPPEL DE DROITE AU CENTRE	ZB4BD8	SCHNEIDER ELECTRIC	1
	CORPS CONTACT 2NO	ZB4BZ103	SCHNEIDER ELECTRIC	1
	CONTACT VIS ETRIER 1NF	ZBE102	SCHNEIDER ELECTRIC	1
36S02	TETE BOUTON TOURNANT 3 POSITIONS, RAPPEL DE DROITE AU CENTRE	ZB4BD8	SCHNEIDER ELECTRIC	1



3, Rue Pierre Curie
91230 MONTGERON
Tél. : 01.69.52.47.00 - Fax : 01.69.52.47.01
e-mail : seguin@automatismes-seguin.fr
http://www.automatismes-seguin.fr

NOMENCLATURE

CLIENT ET NOM DU DOSSIER / CUSTOMER AND NAME OF FOLDER		INDICE / REVIEW
SAUR		1
Armoire De Surpression Du Ruvet		
DESSINATEUR DRAWER	M.H.	FOLIO/SHEET 61/62
N° AFFAIRE N° PROJECT	180253	
		IGE XAO VARZ SERVICE PACK 11-14-49-FI

