

01/09/2017	0	F.CO.	RETOUR ESSAIS	F.C.	R.M.
12/07/2017	A	M.D.	PREMIERE EMISSION	F.C.	R.M.
DATE	REV.	DESSINE PAR	MODIFICATIONS	VERIFIE PAR	APPROUVE PAR
DATE	REV.	DRAWN BY	REVISIONS	CHECKED BY	APPROVED BY

***SCHEMA ELECTRIQUE  
ELECTRICAL DRAWING***



**AUTOMATISMES  
SEGUIN**  
*Système Qualité*

3, Rue Pierre Curie  
91230 MONTGERON  
Tél. : 01.69.52.47.00 - Fax : 01.69.52.47.01  
e-mail : [seguin@automatismes-seguin.fr](mailto:seguin@automatismes-seguin.fr)  
<http://www.automatismes-seguin.fr>

PLAN: 170260	REV: 0
CDE: 17072791 YP 00900	

Ce document est notre propriété. Il ne peut être reproduit et / ou communiqué sans autorisation.  
This document is our property. It cannot be reproduced and / or transmitted without authorization.



*Armoire de commande vannage*

*Perray en Yvelines*



LETTRE DE REPERAGE DES ELEMENTS DU SCHEMA

QI	INTERRUPTEUR	PCPI	CONTROLEUR D'ISOLEMENT	KT	RELAIS TEMPORISE	SA	COMMUTATEUR D'AMPEREMETRE
QIG	INTERRUPTEUR GENERAL	TR	TRANSFORMATEUR DE TENSION	KAU	RELAIS ARRET D'URGENCE	SV	COMMUTATEUR DE VOLTMETRE
QD	DISJONCTEUR	TC	TRANSFORMATEUR DE COURANT	UF	VARIATEUR	ECH	RESISTANCE CHAUFFANTE
QDG	DISJONCTEUR GENERAL	U	ONDULEUR, ALIMENTATION	UM	DEMARREUR	ECL	ECLAIRAGE
FP	PARAFODRE	KIC	INTER CREPUSCULAIRE	S	ORGANE DE COMMANDE	G	BATTERIE
FU	FUSIBLE	KIH	HORLOGE	H	VOYANT, SIRENE	P	INSTRUMENTATION
F	THERMIQUE	KTH	THERMOSTAT	PCH	COMPTEUR HORAIRE	X	PRISE DE COURANT, BORNIER
QF	SECTIONNEUR FUSIBLE	KM	CONTACTEUR	PA	AMPEREMETRE	E	MATERIELS AUTRES
PF	CONTROLEUR DE PHASE	KA	RELAIS	PV	VOLTMETRE	KTL	TELERUPTEUR

LETTER CODES FOR ITEMS DESIGNATION ON THE DRAWING

QI	SWITCH	PCPI	INSULATION CONTROLLER	KT	TEMPORIZES RELAY	SA	AMPEREMETER SWITCH
QIG	GENERAL SWITCH	TR	TENSION TRANSFORMER	KAU	EMERGENCY STOP RELAY	SV	VOLTMETER SWITCH
QD	BREAKER	TC	CURRENT TRANSFORMER	UF	VELOCITY VARIATOR	ECL	LIGHT
QDG	GENERAL BREAKER	U	INVERTER, SUPPLY	UM	MOTOR STARTER	ECH	HEATER
FP	LIGHTNING PROTECTOR	KIC	DIMMER	S	CONTROL UNIT	G	BATTERY
FU	FUSE	KIH	CLOCK	H	INDICATOR	P	INSTRUMENTATION
F	THERMAL RELAY	KTH	THERMOSTAT	PCH	TIMER	X	SOCKET, TERMINAL BLOCK
QF	DISCONNECTING SWITCH	KM	CONTACTOR	PA	AMPEREMETER	E	OTHER EQUIPMENTS
PF	PHASE CONTROLLER	KA	RELAY	PV	VOLTMETER	KTL	TELEBREAKER

COULEURS DE FILS

TRI 400V: <= 6 mm2 Noir Rouge Brun  
> 6 mm2 Noir Bagué Noir Rouge Brun

NEUTRE: Bleu Clair

230VAC: Rouge avec Commun Bobines Blanc (\*)

230VAC ONDULE: Neutre Bleu Clair Bagué Orange  
Phase Noir Bagué Orange

110VAC: Noir avec Commun Bobines Blanc (\*)

24VAC: Violet avec Commun Bobines Blanc (\*)

24VDC: Bleu Foncé avec Commun Bobines Blanc (\*)

48VAC: Violet avec Commun Bobines Blanc (\*)

48VDC: Bleu Foncé avec Commun Bobines Blanc (\*)

REPORTS: Orange

TERRE: Vert/Jaune

ANALOGIQUE: Une Paire + Brun - Blanc  
Unifilaire Blanc

TENSION EXTERNE PERMANENTE INTER GENERAL OUVERT: Orange

ATTENTION

Si plusieurs tensions de télécommande, alors prendre uniquement le 230VAC avec Commun Bobines Blanc

(\*) Si Télécommande

WIRE COLOR

TRI 400V: <= 6 mm2 Black Red Brown  
> 6 mm2 Black with Ring Black Red Brown

NEUTRE: Light Blue

230VAC: Red with Spods Common White (\*)

230VAC UPS: Neutre Light Blue with Ring Orange  
Phase Black with Ring Orange

110VAC: Black with Spods Common White (\*)

24VAC: Purple with Spods Common White (\*)

24VDC: Dark Blue with Spods Common White (\*)

48VAC: Purple with Spods Common White (\*)

48VDC: Dark Blue with Spods Common White (\*)

REPORTS: Orange

GROUND: Green/Yellow

ANALOGICAL: One Pair + Brown - White  
Unifilar White

PERMANENTLY EXTERNAL POWER GENERAL BREAKER OPEN: Orange

CAUTION

If There are Several Tensions of Command Then to take Only the 230VAC with Spods Common White

(\*) If Command

TYPE DE RELAIS ET DE CONTACT DANS LE SCHEMA

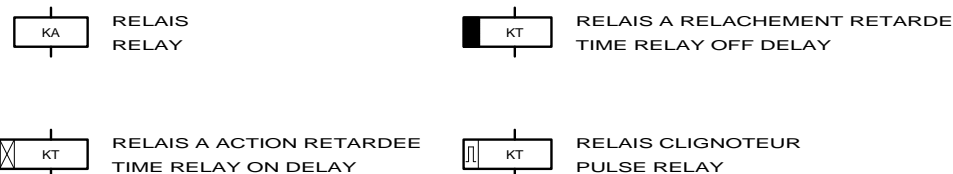

RELAY AND CONTACT TYPE IN THE DRAWING

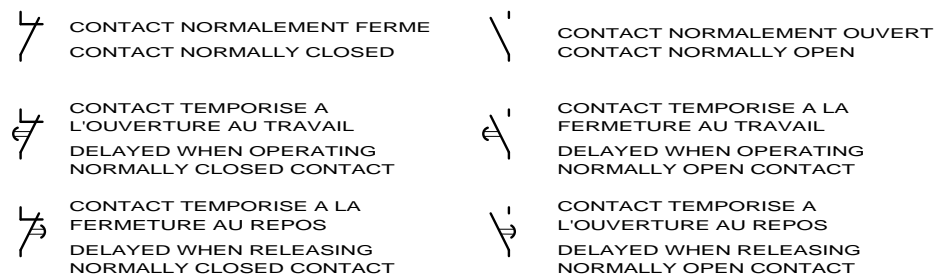

LE SCHEMA EST REPRESENTE HORS TENSION ET GENERATEUR HORS SERVICE

THE DRAWING IS SHOWN OUT OF VOLTAGE AND WITH GENERATOR OUT OF SERVICE



3, Rue Pierre Curie  
91230 MONTGERON  
Tél. : 01.69.52.47.00 - Fax : 01.69.52.47.01  
e-mail : seguin@automatismes-seguin.fr  
http://www.automatismes-seguin.fr

LEGENDE DU SCHEMA ELECTRIQUE

CLIENT ET NOM DU DOSSIER / CUSTOMER AND NAME OF FOLDER		INDICE / REVIEW
SAUR		0
Armoire de commande vannage		IGE-XAO
DESSINATEUR / DRAWER	M.D.	FOLIO/SHEET 03/04
N° AFFAIRE / N° PROJECT	170260	VARZ

CODE DU REPERAGE

LETTER CODE

1/ DES APPAREILS DANS LES ARMOIRES  
APPARATUS IN THE CABINETS



52 KA 01

N° D'ORDRE DANS LE FOLIO D'ORIGINE  
ORDER NUMBER ON ORIGINAL SHEET

LETTRE DE REPERAGE  
LETTER CODES FOR ITEM

N° DU FOLIO D'ORIGINE  
ORIGINAL SHEET NUMBER

2/ DES FILS DE CABLAGE  
WIRING

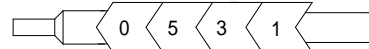

N° DU FOLIO D'ORIGINE  
ORIGINAL SHEET NUMBER

N° DU FIL DANS LE FOLIO D'ORIGINE  
NUMBER OF THE WIRE ON ORIGINAL SHEET

3/ REPORT DES CONTACTS DANS LE SCHEMA  
CONTACT REPORT IN THE DRAWING



17.29

N° DE LA COLONNE OU EST UTILISE LE CONTACT  
COLUMN NUMBER WHERE THE CONTACT IS USED

N° DU FOLIO OU EST UTILISE LE CONTACT  
SHEET NUMBER WHERE THE CONTACT IS USED

4/ REPRESENTATION DES BORNES ET BORNIERES DANS LE SCHEMA  
BINDINGS SCREWS VIEW IN THE DRAWING



N° D'ORDRE (SI NECESSAIRE)  
ORDER NUMBER (IF NECESSARY)

NATURE DU BORNIER  
NATURE OF TERMINAL BLOCK

- A : ALIMENTATION
- P : PUISSANCE
- T : TELECOMMANDE
- M : MESURE
- R : REPORTS



LE SCHEMA EST REPRESENTE HORS TENSION ET GENERATEUR HORS SERVICE

THE DRAWING IS SHOWN OUT OF VOLTAGE AND WITH GENERATOR OUT OF SERVICE



3, Rue Pierre Curie  
91230 MONTGERON  
Tél. : 01.69.52.47.00 - Fax : 01.69.52.47.01  
e-mail : seguin@automatismes-seguin.fr  
http://www.automatismes-seguin.fr

LEGENDE DU SCHEMA ELECTRIQUE

CLIENT ET NOM DU DOSSIER / CUSTOMER AND NAME OF FOLDER		INDICE / REVIEW
SAUR		0
Armoire de commande vannage		IGE-XAO
DESSINATEUR DRAWER	M.D.	FOLIO/SHEET 04/05
N° AFFAIRE N° PROJECT	170260	V4R2

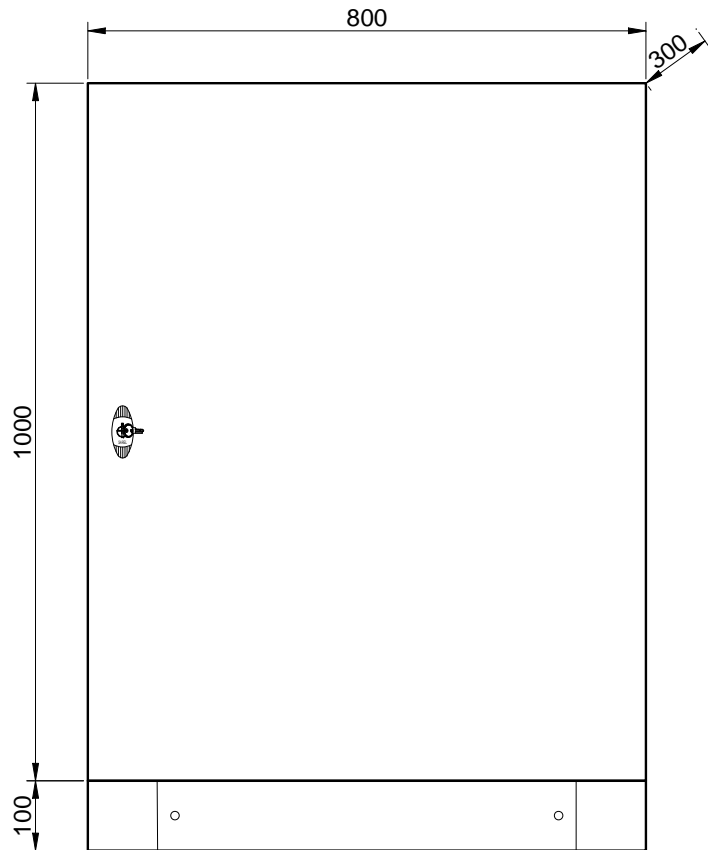

IMPLANTATION FACADE



 3, Rue Pierre Curie  
 91230 MONTGERON  
 Tél. : 01.69.52.47.00 - Fax : 01.69.52.47.01  
 e-mail : seguin@automatismes-seguin.fr  
 http://www.automatismes-seguin.fr

IMPLANTATION EXTERNE

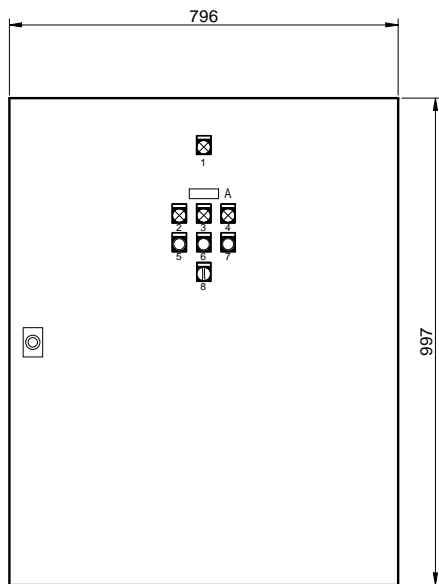
CLIENT ET NOM DU DOSSIER / CUSTOMER AND NAME OF FOLDER		INDICE / REVIEW
SAUR		0
Armoire de commande vannage		
DESSINATEUR / DRAWER	M.D.	FOLIO/SHEET 05 / 06
N° AFFAIRE / N° PROJECT	170260	V4R2

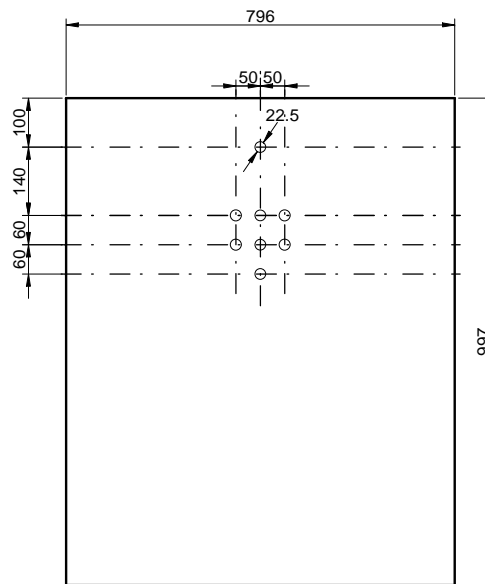

IMPLANTATION FACADE  
PORTE INTERIEURE



PLAN DE DECOUPE  
PORTE INTERIEURE

**ETIQUETTES 60x20**

A - VANNE

**ETIQUETTES SCHNEIDER**

- 1 - SOUS TENSION
- 2 - OUVERTE
- 3 - DEFAULT
- 4 - FERMEE
- 5 - OUVERTURE
- 6 - ARRET
- 7 - FERMETURE
- 8 - AUTO / 0 / MAIN



3, Rue Pierre Curie  
91230 MONTGERON  
Tél. : 01.69.52.47.00 - Fax : 01.69.52.47.01  
e-mail : seguin@automatismes-seguin.fr  
http://www.automatismes-seguin.fr

**IMPLANTATION PORTE INTERIEURE**

CLIENT ET NOM DU DOSSIER / CUSTOMER AND NAME OF FOLDER		INDICE / REVIEW
SAUR		0
Armoire de commande vannage		<b>IGE-XAO</b>
DESSINATEUR DRAWER	M.D.	FOLIO/SHEET 06 / 10
N° AFFAIRE N° PROJECT	170260	V4R2

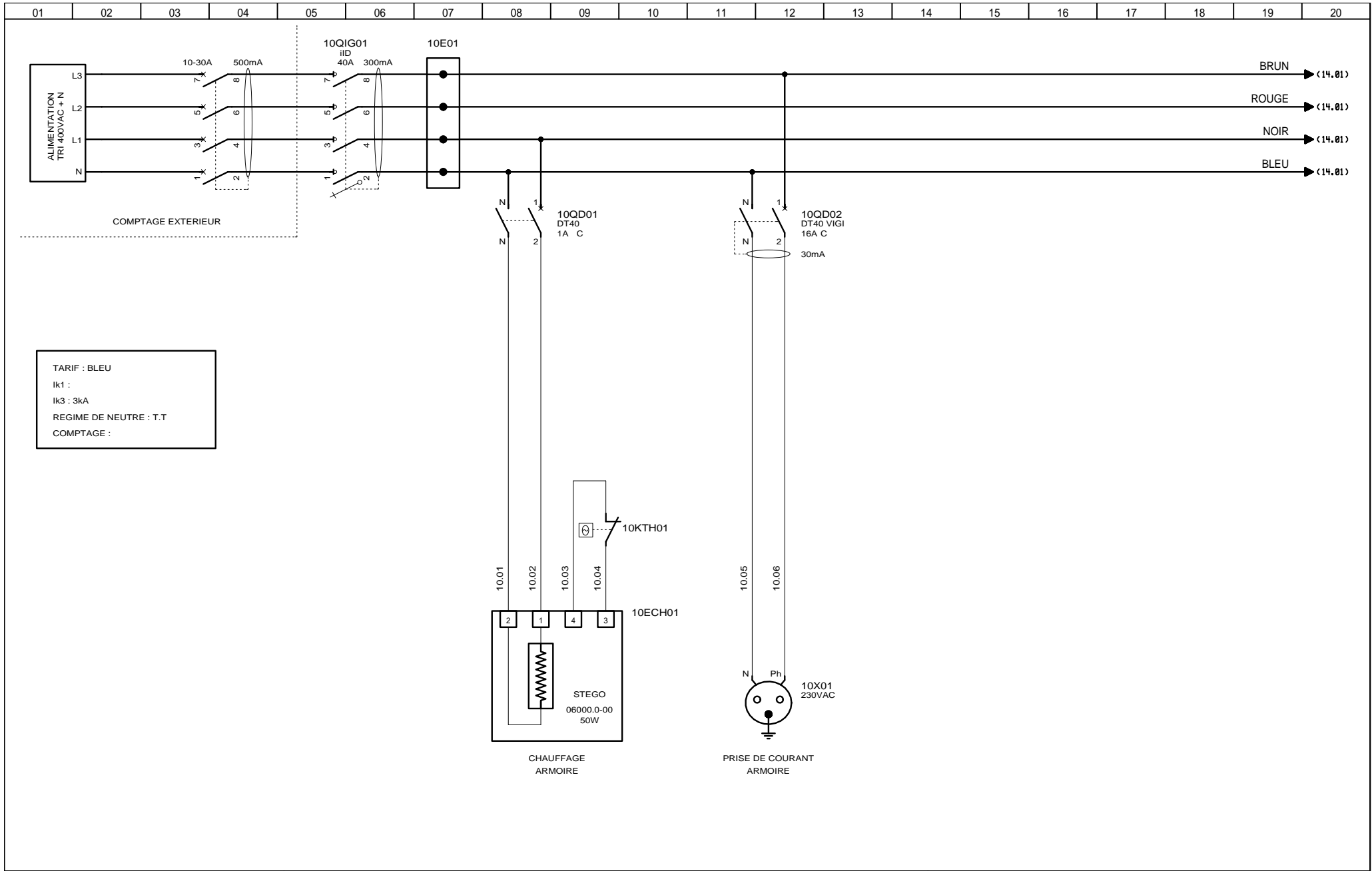

TARIF : BLEU  
 Ik1 :  
 Ik3 : 3kA  
 REGIME DE NEUTRE : T.T  
 COMPTAGE :

**DISTRIBUTION 400VAC + N**

CLIENT ET NOM DU DOSSIER / CUSTOMER AND NAME OF FOLDER		INDICE / REVIEW
SAUR		0
Armoire de commande vannage		<b>IGE-XAO</b>
DESSINATEUR / DRAWER	M.D.	FOLIO/SHEET 10 / 14
N° AFFAIRE / N° PROJECT	170260	V4R2

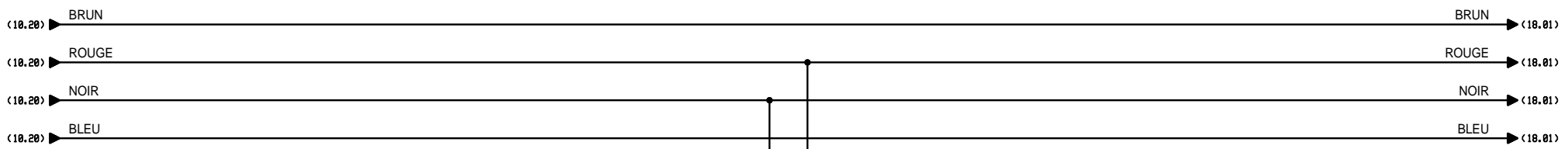

400VAC + N

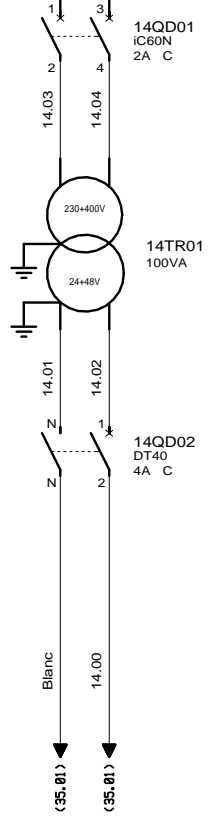

TELECOMMANDE  
SIGNALISATION



3, Rue Pierre Curie  
91230 MONTGERON  
Tél. : 01.69.52.47.00 - Fax : 01.69.52.47.01  
e-mail : seguin@automatismes-seguin.fr  
http://www.automatismes-seguin.fr

## FORMATION DES TENSIONS

CLIENT ET NOM DU DOSSIER / CUSTOMER AND NAME OF FOLDER		INDICE / REVIEW
SAUR		O
Armoire de commande vannage		 V4R2
DESSINATEUR / DRAWER	M.D.	
N° AFFAIRE / N° PROJECT	170260	
FOLIO/SHEET 14 / 18		

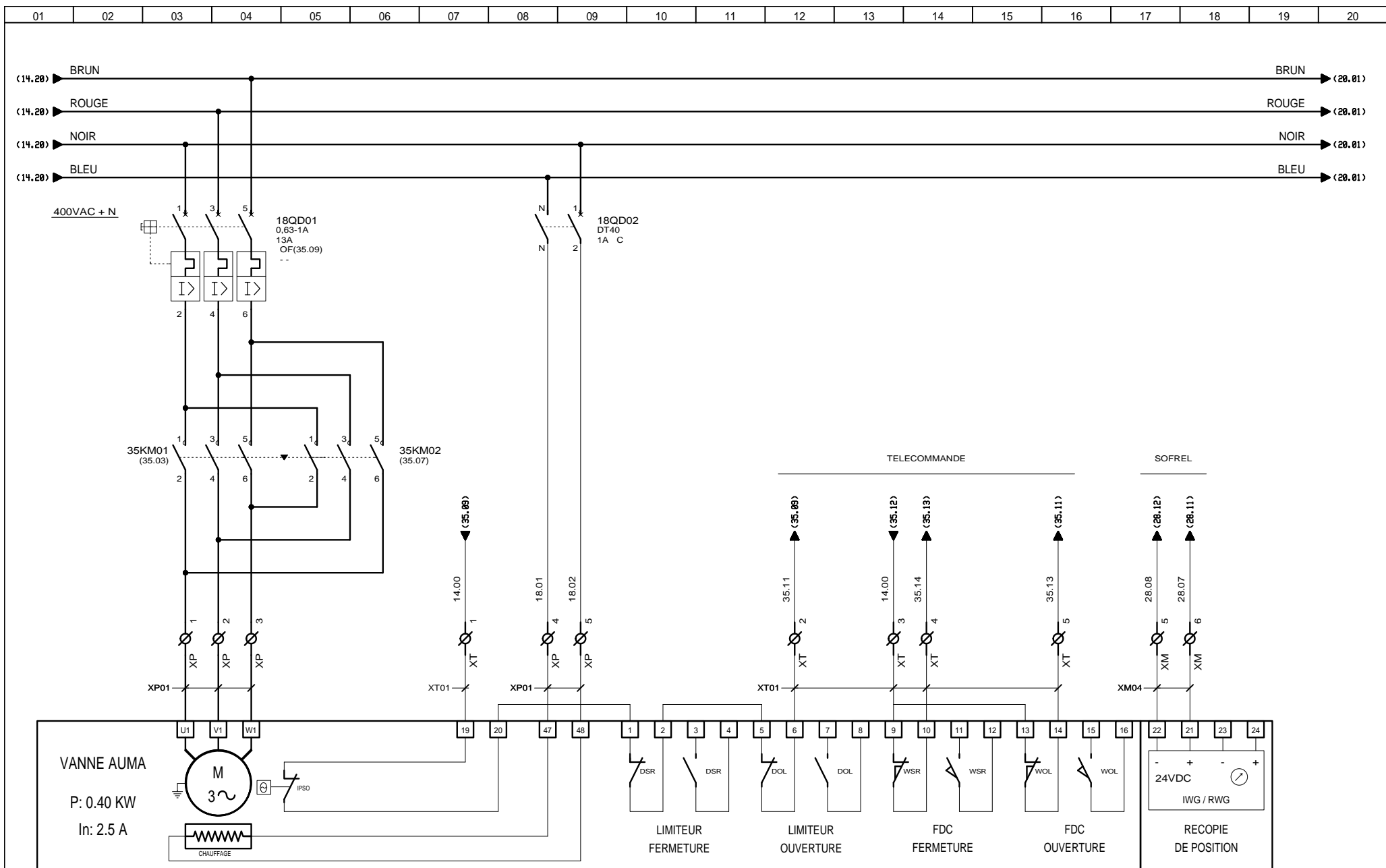

3, Rue Pierre Curie  
91230 MONTGERON  
Tél. : 01.69.52.47.00 - Fax : 01.69.52.47.01  
e-mail : seguin@automatismes-seguin.fr  
http://www.automatismes-seguin.fr

## PUISSANCE VANNE

CLIENT ET NOM DU DOSSIER / CUSTOMER AND NAME OF FOLDER		INDICE / REVIEW
SAUR		O
Armoire de commande vannage		IGE-XAO
DESSINATEUR DRAWER	M.D.	FOLIO/SHEET 18/20
N° AFFAIRE N° PROJECT	170260	VAR2

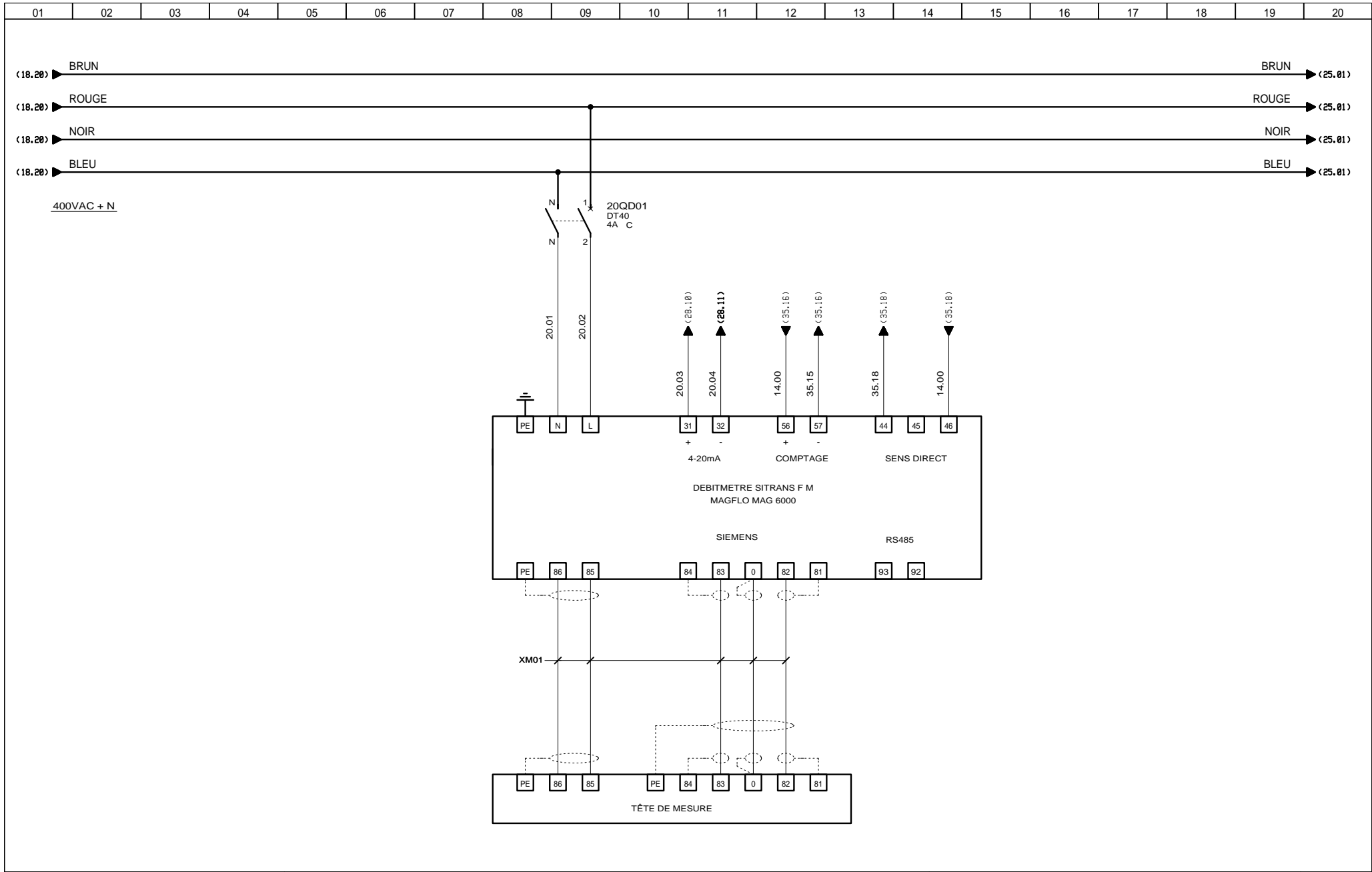

3, Rue Pierre Curie  
91230 MONTGERON  
Tél. : 01.69.52.47.00 - Fax : 01.69.52.47.01  
e-mail : seguin@automatismes-seguin.fr  
http://www.automatismes-seguin.fr

### MESURE DE DEBIT

CLIENT ET NOM DU DOSSIER / CUSTOMER AND NAME OF FOLDER		INDICE / REVIEW
SAUR		O
Armoire de commande vannage		 VAR2
DESSINATEUR / DRAWER	M.D.	
N° AFFAIRE / N° PROJECT	170260	
FOLIO/SHEET 20 / 25		

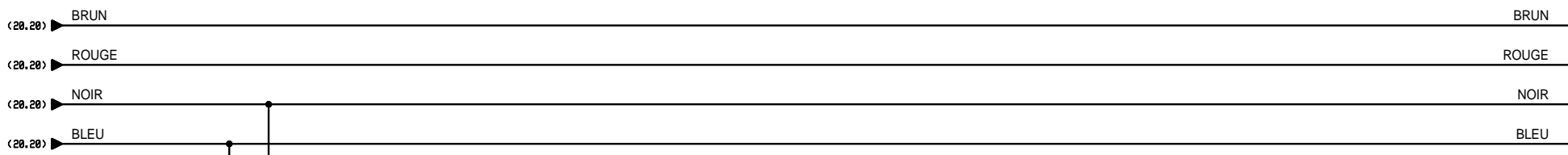

SOFREL S550 (VUE DE DESSOUS)

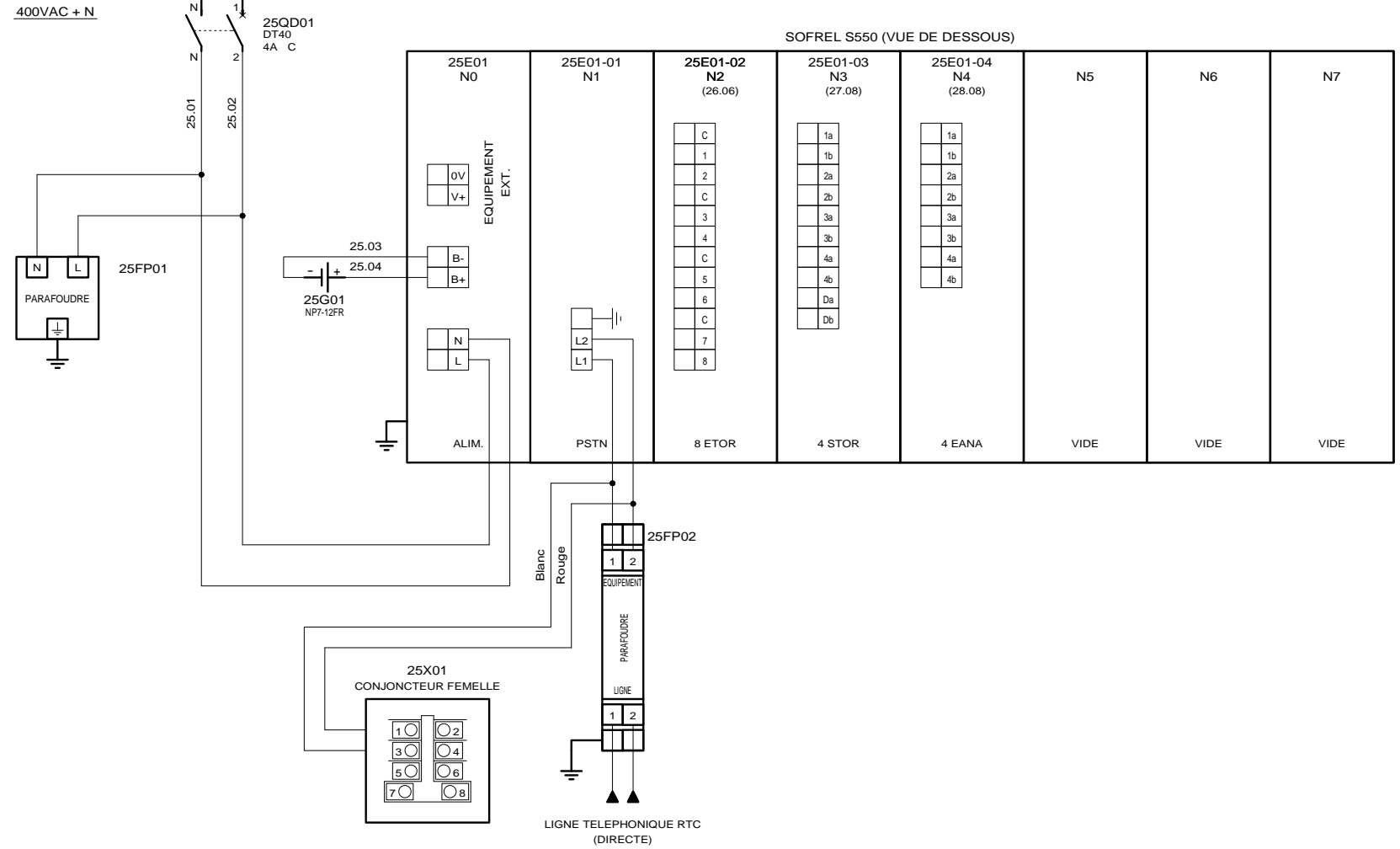

3, Rue Pierre Curie  
91230 MONTGERON  
Tél. : 01.69.52.47.00 - Fax : 01.69.52.47.01  
e-mail : seguin@automatismes-seguin.fr  
http://www.automatismes-seguin.fr

## ARCHITECTURE SOFREL S550

CLIENT ET NOM DU DOSSIER / CUSTOMER AND NAME OF FOLDER		INDICE / REVIEW
SAUR		0
Armoire de commande vannage		
DESSINATEUR / DRAWER	M.D.	FOLIO/SHEET 25 / 26
N° AFFAIRE / N° PROJECT	170260	
		VARZ

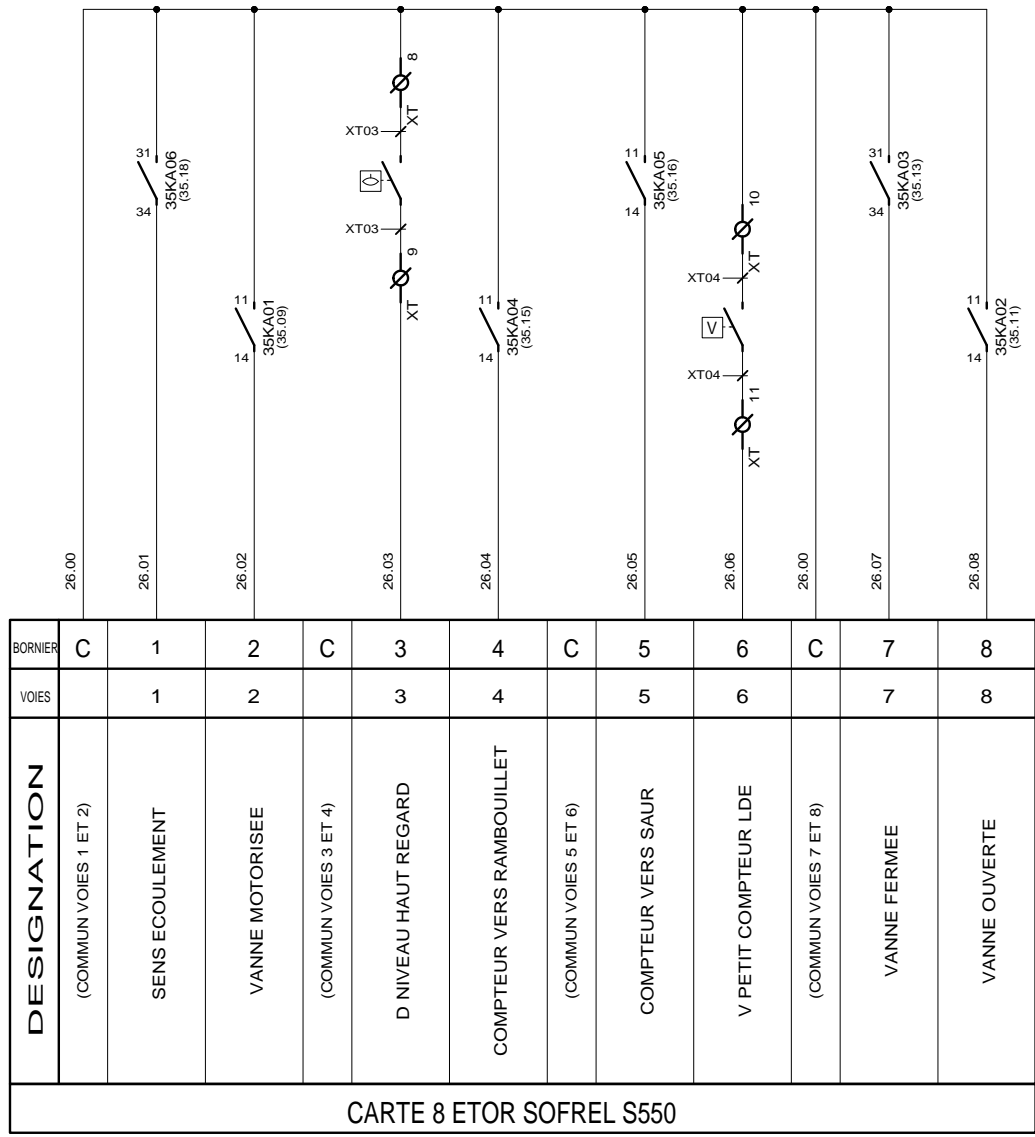

25E01-02  
(25.09)

### CARTE 8 ENTrees TOR EMPLACEMENT 2

CLIENT ET NOM DU DOSSIER / CUSTOMER AND NAME OF FOLDER		INDICE / REVIEW
SAUR		0
Armoire de commande vannage		
DESSINATEUR DRAWER	M.D.	FOLIO/SHEET 26 / 27
N° AFFAIRE N° PROJECT	170260	
		VLRZ

CARTE 4 STOR-WDG SOFREL S550										
DESIGNATION	OUVERTURE VANNE		FERMETURE VANNE							
VOIES	1		2		3		4		5	
BORNIER	1a	1b	2a	2b	3a	3b	4a	4b	Da	Db

25E01-03  
(25.10)

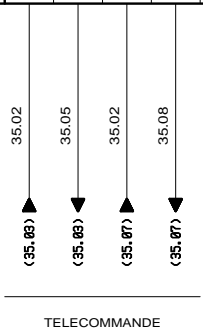

RACCORDEMENT :  
POUR CAPTEUR AUTONOME



RACCORDEMENT :  
POUR CAPTEUR TELEALIMENTE

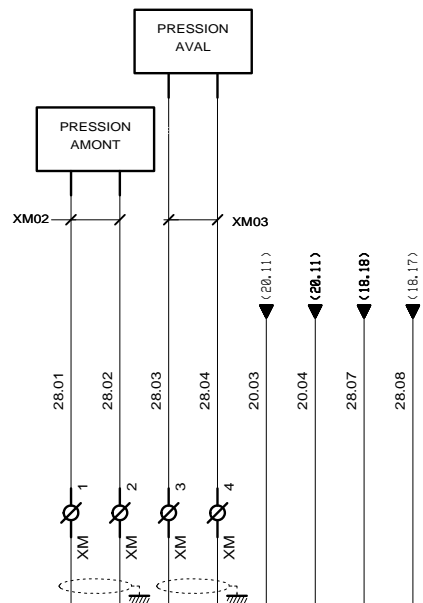

25E01-04  
(25.11)

BORNIER	1a	1b	2a	2b	3a	3b	4a	4b
VOIES	1		2		3		4	
DESIGNATION	MESURE DE PRESSION AMONT		MESURE DE PRESSION AVAL		RECOPIE VANNE DE POSITION		DEBIT	
CARTE 4 EANA SOFREL S550								



3, Rue Pierre Curie  
91230 MONTGERON  
Tél. : 01.69.52.47.00 - Fax : 01.69.52.47.01  
e-mail : seguin@automatismes-seguin.fr  
http://www.automatismes-seguin.fr

### CARTE 2 ENTrees ANA EMPLACEMENT 4

CLIENT ET NOM DU DOSSIER / CUSTOMER AND NAME OF FOLDER			INDICE / REVIEW
SAUR Armoire de commande vannage			0
DESSINATEUR DRAWER	M.D.	FOLIO/SHEET	28 / 35
N° AFFAIRE N° PROJECT	170260		V4R2

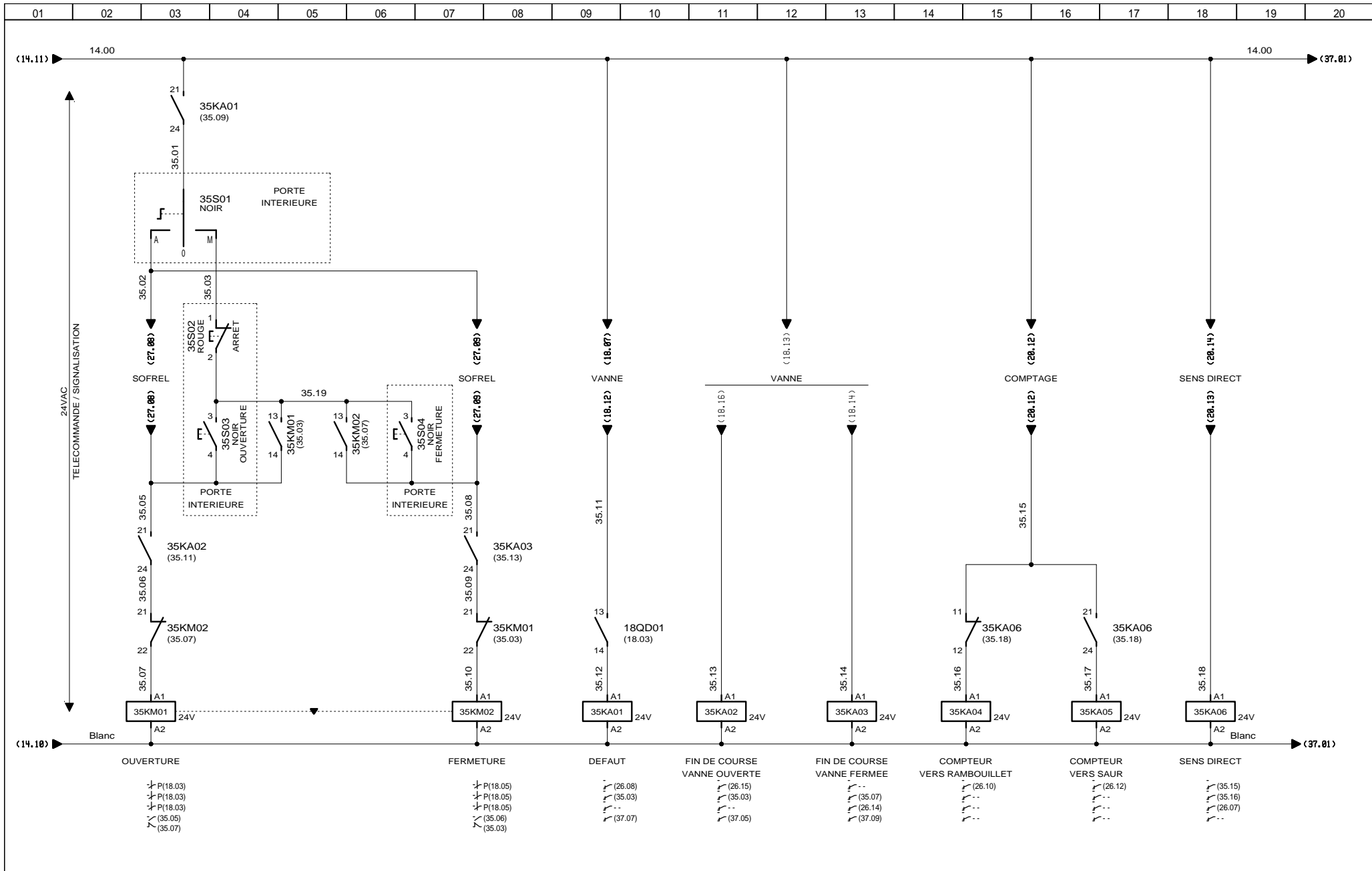

3, Rue Pierre Curie  
91230 MONTGERON  
Tél. : 01.69.52.47.00 - Fax : 01.69.52.47.01  
e-mail : seguin@automatismes-seguin.fr  
http://www.automatismes-seguin.fr

## TELECOMMANDE VANNE

CLIENT ET NOM DU DOSSIER / CUSTOMER AND NAME OF FOLDER		INDICE / REVIEW
SAUR		O
Armoire de commande vannage		IGE XAO
DESSINATEUR DRAWER	M.D.	VAR2
N° AFFAIRE N° PROJECT	170260	FOLIO/SHEET 35 / 37

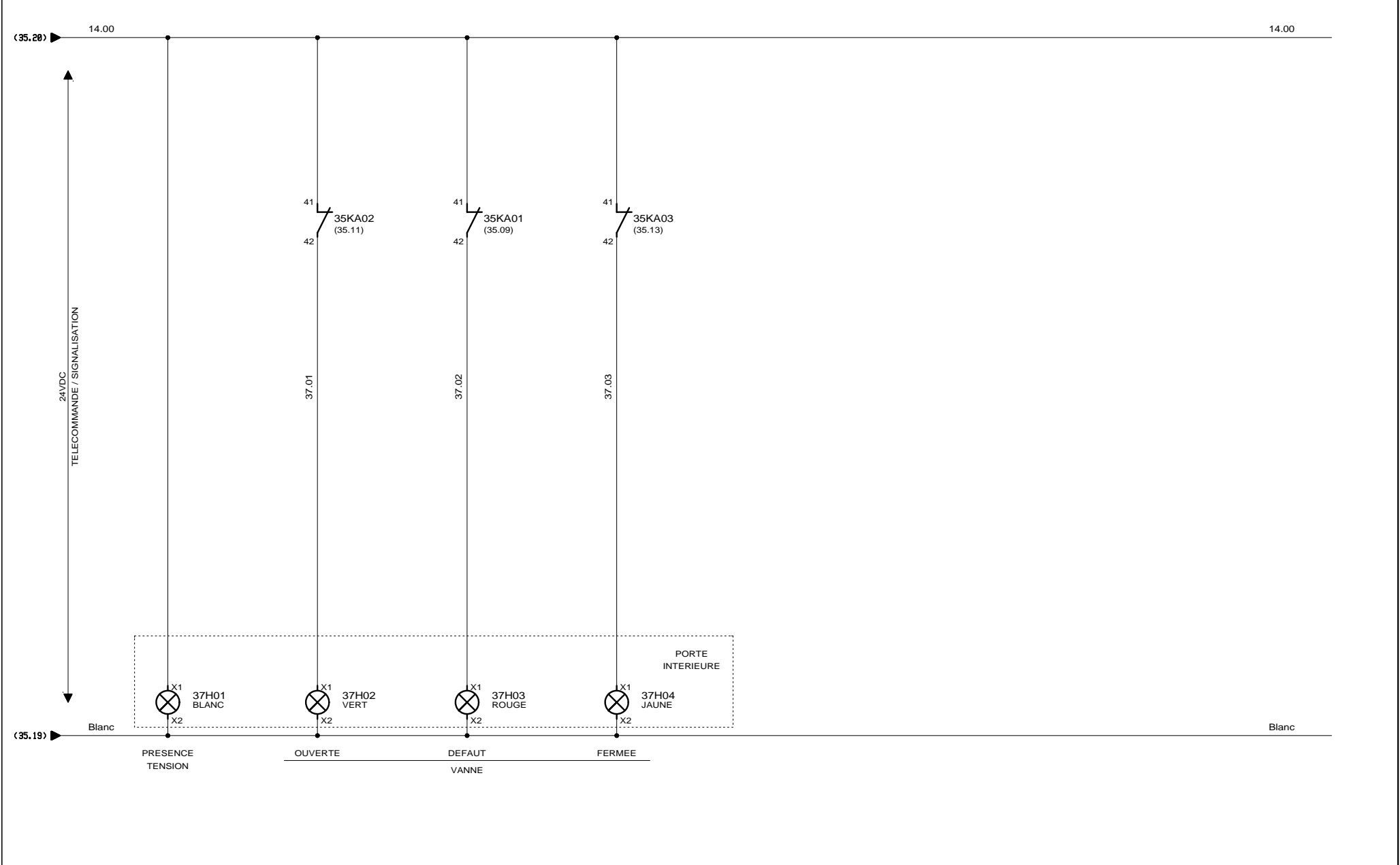

 3, Rue Pierre Curie  
 91230 MONTGERON  
 Tél. : 01.69.52.47.00 - Fax : 01.69.52.47.01  
 e-mail : seguin@automatismes-seguin.fr  
 http://www.automatismes-seguin.fr

## SIGNALISATION

CLIENT ET NOM DU DOSSIER / CUSTOMER AND NAME OF FOLDER		INDICE / REVIEW
SAUR		0
Armoire de commande vannage		
DESSINATEUR DRAWER	M.D.	
N° AFFAIRE N° PROJECT	170260	FOLIO/SHEET 37 / 40
		VARZ

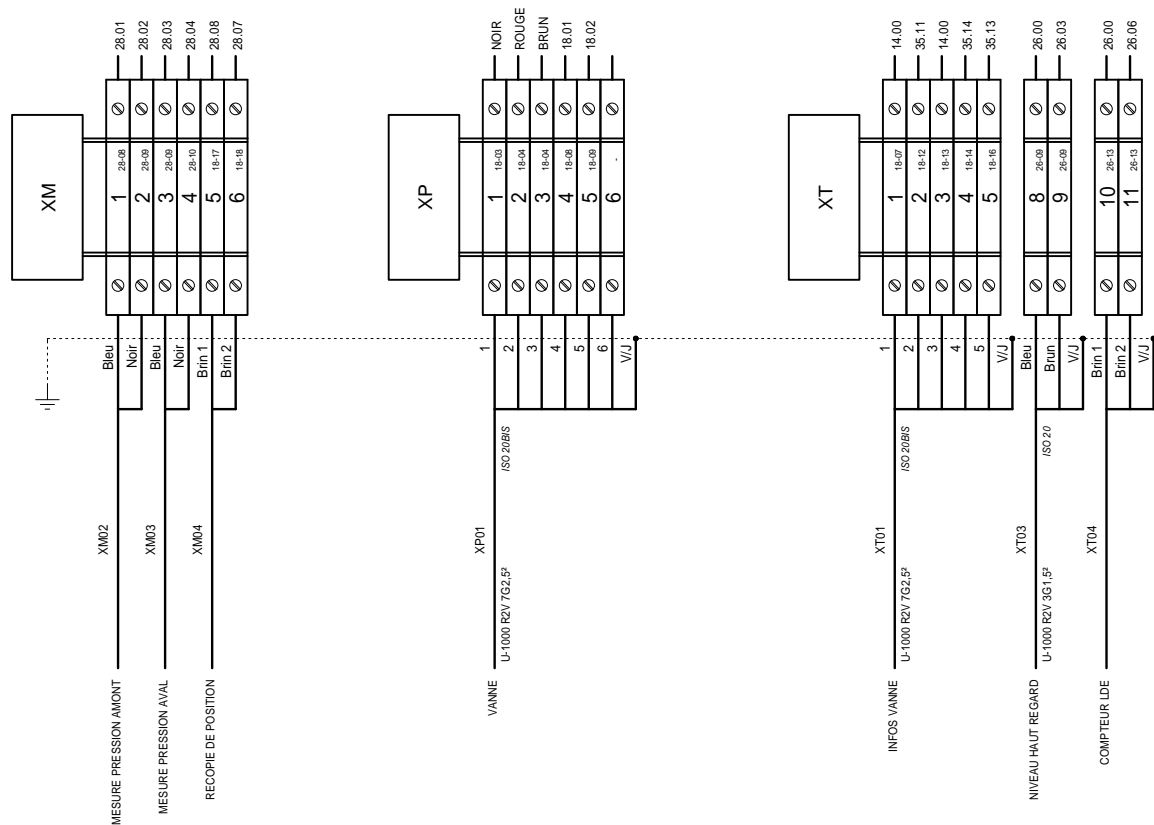

### BORNIERS

CLIENT ET NOM DU DOSSIER / CUSTOMER AND NAME OF FOLDER		INDICE / REVIEW
SAUR		0
Armoire de commande vannage		
DESSINATEUR / DRAWER	M.D.	FOLIO/SHEET 40 / 42
N° AFFAIRE / N° PROJECT	170260	
		VARZ

REPERE	DESIGNATION	REFERENCE	MARQUE	QTE
TOLERIE	COFFRET UNIVERSEL AVEC PORTE PLEINE SANS CHASSIS 1000x800x300, IP66, RAL7035	NSYS3D10830	SCHNEIDER ELECTRIC	1
	POIGNEE A CLE 1242ZE	NSYAEDL1242S3D	SCHNEIDER ELECTRIC	1
	PORTE INTERNE POUR COFFRET H1000xL800	NSYPIN108	SCHNEIDER ELECTRIC	1
	SOCLE FRONTAL SF/SM 100x800	NSYSPF8100	SCHNEIDER ELECTRIC	1
	JEU DE 2 TRAPPES LATERALES SOCLE SD 100X300	NSYSPS3100SD	SCHNEIDER ELECTRIC	1
10E01	REPARTITEUR TETRAPOLAIRE TD 40 A, 12 CONNEXIONS	563740	ERICO	1
10ECH01	RESISTANCE CHAUFFANTE PTC CS 060, 120-240V AC/DC, 50W	06000.0-00	STEGO	1
10KTH01	PETIT THERMOSTAT KTO 011, 1NF, 0..60°C	01146.9-00	STEGO	1
10QD01	DISJONCTEUR DT40 1P+N 1A 6kA, COURBE C	A9N21019	SCHNEIDER ELECTRIC	1
10QD02	DISJONCTEUR DT40 VIGI 1P+N CLASSE AC 16A 30mA COURBE C	A9N21444	SCHNEIDER ELECTRIC	1
10QIG01	INTERRUPTEUR DIFFERENTIEL IID TYPE AC 415VAC 4P 40A 300mA	A9R14440	SCHNEIDER ELECTRIC	1
10X01	PRISE DE COURANT 2P+T 10/16A, 250VAC A ECLIPS	004280	LEGRAND	1
14QD01	DISJONCTEUR IC60N 2P 2A, 440VAC/25kA, 133VDC/6kA, COURBE C	A9F74202	SCHNEIDER ELECTRIC	1
14QD02	DISJONCTEUR DT40 1P+N 4A 6kA, COURBE C	A9N21022	SCHNEIDER ELECTRIC	1
14TR01	TRANSFORMATEUR DE COMMANDE ET DE SIGNALISATION MONOPHASEE 230-400V/24-48V, 100VA	044233	LEGRAND	1
18QD01	DISJONCTEUR MOTEUR MAGNETO-THERMIQUE 0.63-1A, BORNES A VIS	GV2ME05	SCHNEIDER ELECTRIC	1
	ADDITIF FRONTAL F+O	GVAE11	SCHNEIDER ELECTRIC	1
18QD02	DISJONCTEUR DT40 1P+N 1A 6kA, COURBE C	A9N21019	SCHNEIDER ELECTRIC	1
20QD01	DISJONCTEUR DT40 1P+N 4A 6kA, COURBE C	A9N21022	SCHNEIDER ELECTRIC	1
25E01	RACK S550 8 EMBACEMENTS AVEC ALIM SECTEUR 230VAC	T9950A100	SOFREL	1
	AUTOMATISME PROGRAMMABLE EN LANGAGE ST	TS9500A10	SOFREL	1
25E01-01	MODULE DE COMMUNICATION PSTN (RTC) 33.600 bps	V5900510	SOFREL	1
25E01-02	MODULE D'ENTREES, 8E TOR	V5900210	SOFREL	1
25E01-03	MODULE DE SORTIES, 4S TOR 1S TOR WDG 50V 1A	V5900310	SOFREL	1
25E01-04	MODULE D'ENTREES, 4E ANA MULTISTANDARD	V5900250	SOFREL	1
25FP01	PROTECTION SECTEUR 230V, 5kA, Up=1.2kV	T5300011	SOFREL	1
25FP02	PROTECTION RTC	T5300012	SOFREL	1
25G01	BATTERIE 12V, 7Ah	NP7-12FR	YUASA	1
25QD01	DISJONCTEUR DT40 1P+N 4A 6kA, COURBE C	A9N21022	SCHNEIDER ELECTRIC	1
25X01	PRISE TELEPHONIQUE SAILLIE - 8 CONTACTS	051219	LEGRAND	1
35KA01	RELAIS INDUSTRIEL EMBROCHABLE, MONOSTABLE, 4INV, 24VAC + EMBASE	RMIA4524AC + ZMI4SA	CARLO GAVAZZI	1
35KA02	RELAIS INDUSTRIEL EMBROCHABLE, MONOSTABLE, 4INV, 24VAC + EMBASE	RMIA4524AC + ZMI4SA	CARLO GAVAZZI	1
35KA03	RELAIS INDUSTRIEL EMBROCHABLE, MONOSTABLE, 4INV, 24VAC + EMBASE	RMIA4524AC + ZMI4SA	CARLO GAVAZZI	1
35KA04	RELAIS INDUSTRIEL EMBROCHABLE, MONOSTABLE, 4INV, 24VAC + EMBASE	RMIA4524AC + ZMI4SA	CARLO GAVAZZI	1
35KA05	RELAIS INDUSTRIEL EMBROCHABLE, MONOSTABLE, 4INV, 24VAC + EMBASE	RMIA4524AC + ZMI4SA	CARLO GAVAZZI	1
35KA06	RELAIS INDUSTRIEL EMBROCHABLE, MONOSTABLE, 4INV, 24VAC + EMBASE	RMIA4524AC + ZMI4SA	CARLO GAVAZZI	1
35KM01/35KM02	INVERSEUR 9A 1NO+1NF 24V 50/60Hz	LC2D09B7	SCHNEIDER ELECTRIC	1
35S01	TETE BOUTON TOURNANT 3 POSITIONS	ZB4BD3	SCHNEIDER ELECTRIC	1
	CORPS CONTACT 2NO	ZB4BZ103	SCHNEIDER ELECTRIC	1
	CONTACT VIS ETRIER 1NO	ZBE101	SCHNEIDER ELECTRIC	1
35S02	TETE BOUTON POUSSOIR ROUGE	ZB4BA4	SCHNEIDER ELECTRIC	1
	CORPS CONTACT NF	ZB4BZ102	SCHNEIDER ELECTRIC	1
35S03	TETE BOUTON POUSSOIR NOIR	ZB4BA2	SCHNEIDER ELECTRIC	1
	CORPS CONTACT NO	ZB4BZ101	SCHNEIDER ELECTRIC	1
35S04	TETE BOUTON POUSSOIR NOIR	ZB4BA2	SCHNEIDER ELECTRIC	1
	CORPS CONTACT NO	ZB4BZ101	SCHNEIDER ELECTRIC	1
37H01	VOYANT INCOLORE DEL 24V	XB7EV07BP	SCHNEIDER ELECTRIC	1



3, Rue Pierre Curie  
91230 MONTGERON  
Tél. : 01.69.52.47.00 - Fax : 01.69.52.47.01  
e-mail : seguin@automatismes-seguin.fr  
http://www.automatismes-seguin.fr

NOMENCLATURE

CLIENT ET NOM DU DOSSIER / CUSTOMER AND NAME OF FOLDER		INDICE / REVIEW
SAUR		0
Armoire de commande vannage		
DESSINATEUR DRAWER	M.D.	FOLIO/SHEET 42 / 43
N° AFFAIRE N° PROJECT	170260	
		VAR2

