

11/10/2017	0	C.C.	RETOUR ESSAIS	F.C.	R.M.
26/07/2017	A	F.CO.	PREMIERE EMISSION	F.C.	R.M.
DATE	REV.	DESSINE PAR	MODIFICATIONS	VERIFIE PAR	APPROUVE PAR
DATE	REV.	DRAWN BY	REVISIONS	CHECKED BY	APPROVED BY

***SCHEMA ELECTRIQUE
ELECTRICAL DRAWING***



3, Rue Pierre Curie
91230 MONTGERON
Tél. : 01.69.52.47.00 - Fax : 01.69.52.47.01
e-mail : seguin@automatismes-seguin.fr
<http://www.automatismes-seguin.fr>

PLAN: 170264	REV: 0
CDE: 17072791 YP 00900	

Ce document est notre propriété. Il ne peut être reproduit et / ou communiqué sans autorisation.
This document is our property. It cannot be reproduced and / or transmitted without authorization.



Armoire Saint-Martin-des-Champs

LETTRE DE REPERAGE DES ELEMENTS DU SCHEMA

QI	INTERRUPTEUR	PCPI	CONTROLEUR D'ISOLEMENT	KT	RELAIS TEMPORISE	SA	COMMUTATEUR D'AMPEREMETRE
QIG	INTERRUPTEUR GENERAL	TR	TRANSFORMATEUR DE TENSION	KAU	RELAIS ARRÊT D'URGENCE	SV	COMMUTATEUR DE VOLTMETRE
QD	DISJONCTEUR	TC	TRANSFORMATEUR DE COURANT	UF	VARIATEUR	ECH	RESISTANCE CHAUFFANTE
QDG	DISJONCTEUR GENERAL	U	ONDULEUR, ALIMENTATION	UM	DEMARREUR	ECL	ECLAIRAGE
FP	PARAFODRE	KIC	INTER CREPUSCULAIRE	S	ORGANE DE COMMANDE	G	BATTERIE
FU	FUSIBLE	KIH	HORLOGE	H	VOYANT, SIRENE	P	INSTRUMENTATION
F	THERMIQUE	KTH	THERMOSTAT	PCH	COMPTEUR HORAIRE	X	PRISE DE COURANT, BORNIER
QF	SECTIONNEUR FUSIBLE	KM	CONTACTEUR	PA	AMPEREMETRE	E	MATERIELS AUTRES
PF	CONTROLEUR DE PHASE	KA	RELAIS	PV	VOLTMETRE	KTL	TELERUPTEUR

LETTER CODES FOR ITEMS DESIGNATION ON THE DRAWING

QI	SWITCH	PCPI	INSULATION CONTROLLER	KT	TEMPORIZES RELAY	SA	AMPEREMETER SWITCH
QIG	GENERAL SWITCH	TR	TENSION TRANSFORMER	KAU	EMERGENCY STOP RELAY	SV	VOLTMETER SWITCH
QD	BREAKER	TC	CURRENT TRANSFORMER	UF	VELOCITY VARIATOR	ECL	LIGHT
QDG	GENERAL BREAKER	U	INVERTER, SUPPLY	UM	MOTOR STARTER	ECH	HEATER
FP	LIGHTNING PROTECTOR	KIC	DIMMER	S	CONTROL UNIT	G	BATTERY
FU	FUSE	KIH	CLOCK	H	INDICATOR	P	INSTRUMENTATION
F	THERMAL RELAY	KTH	THERMOSTAT	PCH	TIMER	X	SOCKET, TERMINAL BLOCK
QF	DISCONNECTING SWITCH	KM	CONTACTOR	PA	AMPEREMETER	E	OTHER EQUIPMENTS
PF	PHASE CONTROLLER	KA	RELAY	PV	VOLTMETER	KTL	TELEBREAKER

COULEURS DE FILS

TRI 400V: <= 6 mm2 Noir Rouge Brun
> 6 mm2 Noir Bagué Noir Rouge Brun

NEUTRE: Bleu Clair

230VAC: Rouge avec Commun Bobines Blanc (*)

230VAC ONDULE: Neutre Bleu Clair Bagué Orange
Phase Noir Bagué Orange

110VAC: Noir avec Commun Bobines Blanc (*)

24VAC: Violet avec Commun Bobines Blanc (*)

24VDC: Bleu Foncé avec Commun Bobines Blanc (*)

48VAC: Violet avec Commun Bobines Blanc (*)

48VDC: Bleu Foncé avec Commun Bobines Blanc (*)

REPORTS: Orange

TERRE: Vert/Jaune

ANALOGIQUE: Une Paire + Brun - Blanc
Unifilaire Blanc

TENSION EXTERNE PERMANENTE INTER GENERAL OUVERT: Orange

ATTENTION

Si plusieurs tensions de télécommande, alors prendre uniquement le 230VAC avec Commun Bobines Blanc

(*) Si Télécommande

WIRE COLOR

TRI 400V: <= 6 mm2 Black Red Brown
> 6 mm2 Black with Ring Black Red Brown

NEUTRE: Light Blue

230VAC: Red with Spods Common White (*)

230VAC UPS: Neutre Light Blue with Ring Orange
Phase Black with Ring Orange

110VAC: Black with Spods Common White (*)

24VAC: Purple with Spods Common White (*)

24VDC: Dark Bleu with Spods Common White (*)

48VAC: Purple with Spods Common White (*)

48VDC: Dark Bleu with Spods Common White (*)

REPORTS: Orange

GROUND: Green/Yellow

ANALOGICAL: One Pair + Brown - White
Unifilar White

PERMANENTLY EXTERNAL POWER GENERAL BREAKER OPEN: Orange

CAUTION

If There are Several Tensions of Command Then to take Only the 230VAC with Spods Common White

(*) If Command

TYPE DE RELAIS ET DE CONTACT DANS LE SCHEMA



RELAY AND CONTACT TYPE IN THE DRAWING

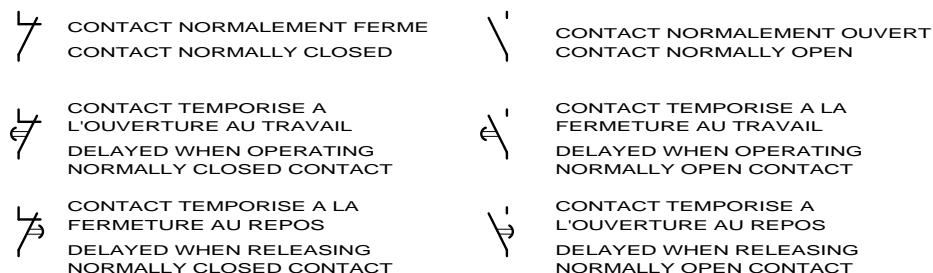

LE SCHEMA EST REPRESENTE HORS TENSION ET GENERATEUR HORS SERVICE

THE DRAWING IS SHOWN OUT OF VOLTAGE AND WITH GENERATOR OUT OF SERVICE



3, Rue Pierre Curie
91230 MONTGERON
Tél. : 01.69.52.47.00 - Fax : 01.69.52.47.01
e-mail : seguin@automatismes-seguin.fr
http://www.automatismes-seguin.fr

LEGENDE DU SCHEMA ELECTRIQUE

CLIENT ET NOM DU DOSSIER / CUSTOMER AND NAME OF FOLDER		INDICE / REVIEW
SAUR		0
Armoire Saint-Martin-des-Champs		IGE-XAO
DESSINATEUR DRAWER	F.CO.	
N° AFFAIRE N° PROJECT	170264	FOLIO/SHEET 03/04
		VARZ

CODE DU REPERAGE

LETTER CODE

1/ DES APPAREILS DANS LES ARMOIRES
APPARATUS IN THE CABINETS



52 KA 01

N° D'ORDRE DANS LE FOLIO D'ORIGINE
ORDER NUMBER ON ORIGINAL SHEET

LETTRE DE REPERAGE
LETTER CODES FOR ITEM

N° DU FOLIO D'ORIGINE
ORIGINAL SHEET NUMBER

2/ DES FILS DE CABLAGE
WIRING

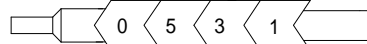

N° DU FOLIO D'ORIGINE
ORIGINAL SHEET NUMBER

N° DU FIL DANS LE FOLIO D'ORIGINE
NUMBER OF THE WIRE ON ORIGINAL SHEET

3/ REPORT DES CONTACTS DANS LE SCHEMA
CONTACT REPORT IN THE DRAWING



17.29

N° DE LA COLONNE OU EST UTILISE LE CONTACT
COLUMN NUMBER WHERE THE CONTACT IS USED

N° DU FOLIO OU EST UTILISE LE CONTACT
SHEET NUMBER WHERE THE CONTACT IS USED

4/ REPRESENTATION DES BORNES ET BORNIERES DANS LE SCHEMA
BINDINGS SCREWS VIEW IN THE DRAWING

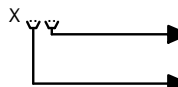

N° D'ORDRE (SI NECESSAIRE)
ORDER NUMBER (IF NECESSARY)

NATURE DU BORNIER
NATURE OF TERMINAL BLOCK

- A : ALIMENTATION
- P : PUISSANCE
- T : TELECOMMANDE
- M : MESURE
- R : REPORTS



LE SCHEMA EST REPRESENTE HORS TENSION ET GENERATEUR HORS SERVICE

THE DRAWING IS SHOWN OUT OF VOLTAGE AND WITH GENERATOR OUT OF SERVICE



3, Rue Pierre Curie
91230 MONTGERON
Tél. : 01.69.52.47.00 - Fax : 01.69.52.47.01
e-mail : seguin@automatismes-seguin.fr
http://www.automatismes-seguin.fr

LEGENDE DU SCHEMA ELECTRIQUE

CLIENT ET NOM DU DOSSIER / CUSTOMER AND NAME OF FOLDER		INDICE / REVIEW
SAUR		0
Armoire Saint-Martin-des-Champs		
DESSINATEUR DRAWER	F.CO.	IGE-XAO
N° AFFAIRE N° PROJECT	170264	FOLIO/SHEET 04 / 05
		VLRZ

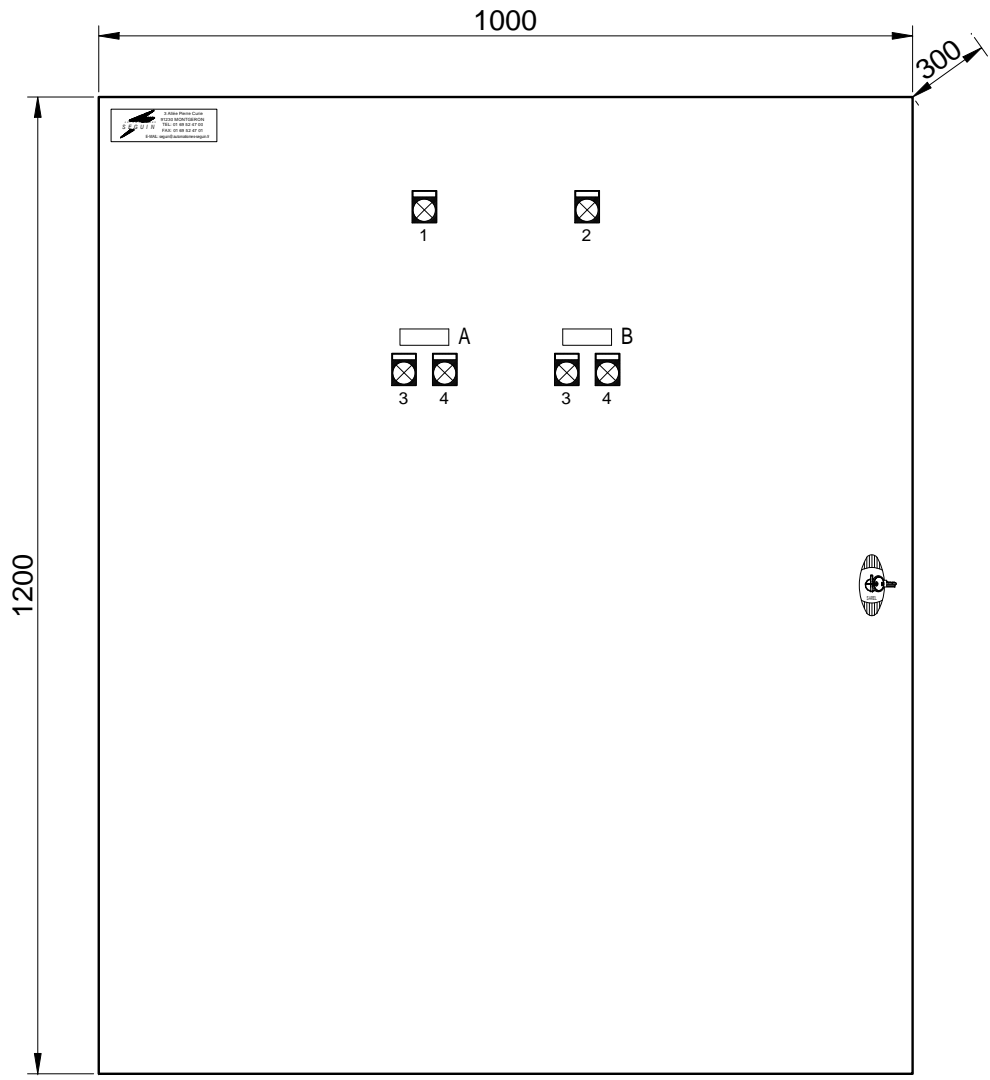

ETIQUETTES 60x20

- A - POMPE 1
- B - POMPE 2

ETIQUETTES SCHNEIDER

- 1 - SOUS TENSION
- 2 - NIVEAU TROP PLEIN
- 3 - MARCHE
- 4 - DEFAULT

IMPLANTATION FACADE



3, Rue Pierre Curie
91230 MONTGERON
Tél. : 01.69.52.47.00 - Fax : 01.69.52.47.01
e-mail : seguin@automatismes-seguin.fr
http://www.automatismes-seguin.fr

IMPLANTATION FACADE

CLIENT ET NOM DU DOSSIER / CUSTOMER AND NAME OF FOLDER		INDICE / REVIEW
SAUR		0
Armoire Saint-Martin-des-Champs		
DESSINATEUR / DRAWER	F.CO.	FOLIO/SHEET 05 / 10
N° AFFAIRE / N° PROJECT	170264	
		V4R2

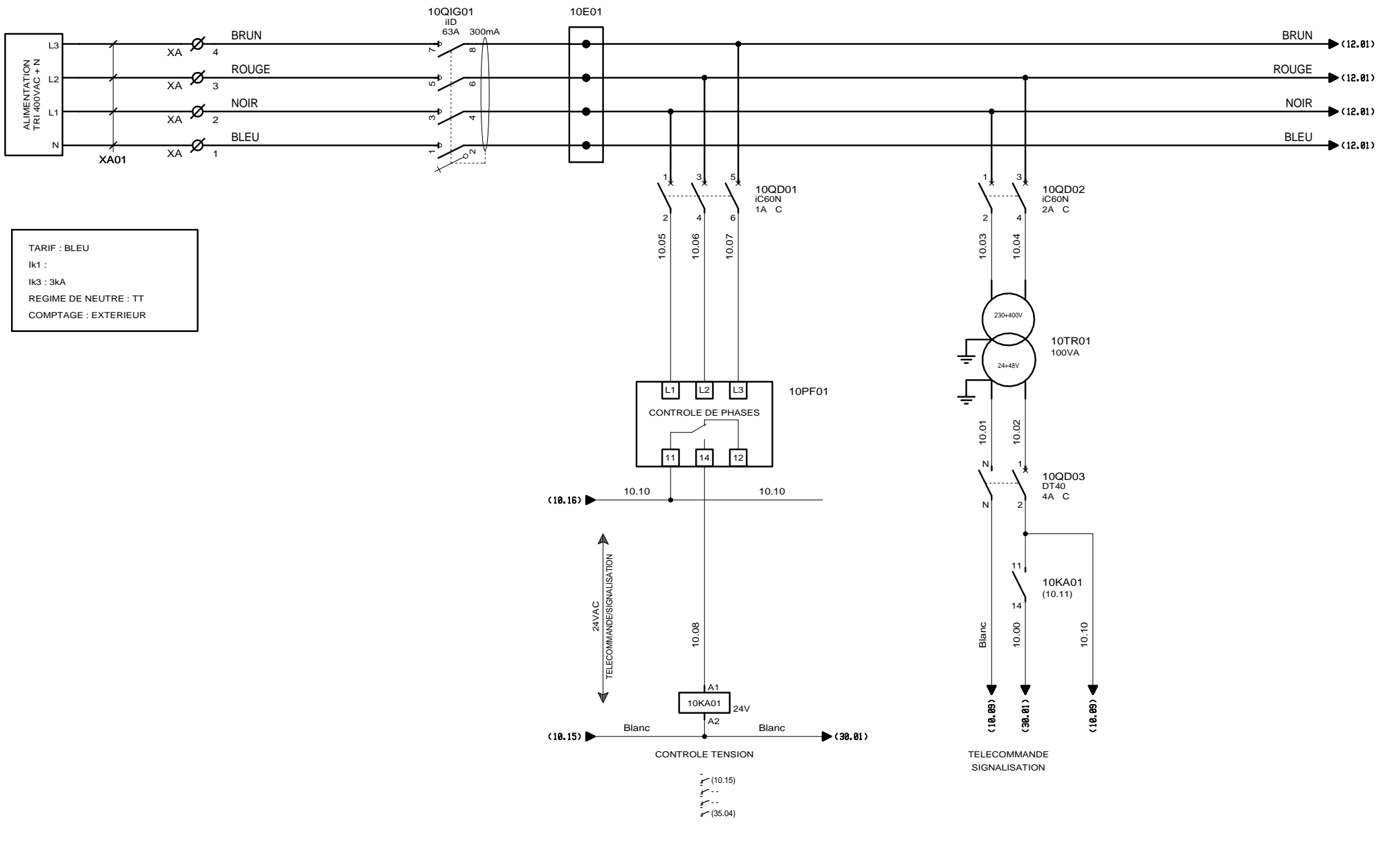



TARIF : BLEU
Ik1 :
Ik3 : 3kA
REGIME DE NEUTRE : TT
COMPTAGE : EXTERIEUR

ARRIVEE GENERALE

AUTOMATISMES SEGUIN
3, Rue Pierre Curie
91230 MONTGERON
Tél. : 01.69.52.47.00 - Fax : 01.69.52.47.01
e-mail : seguin@automatismes-seguin.fr
http://www.automatismes-seguin.fr

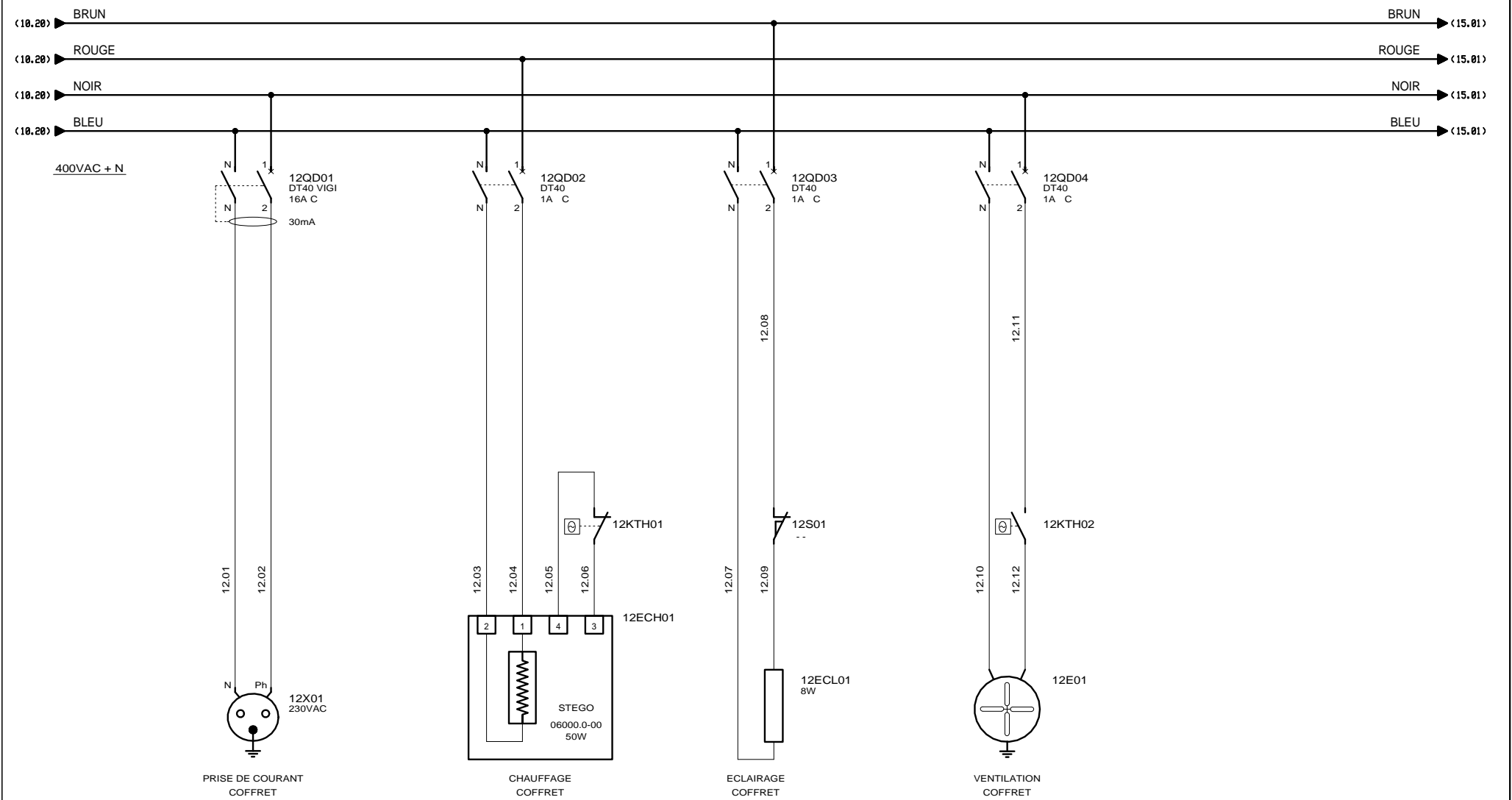
CLIENT ET NOM DU DOSSIER / CUSTOMER AND NAME OF FOLDER		INDICE / REVIEW
SAUR		O
Armoire Saint-Martin-des-Champs		
DESSINATEUR / DRAWER	F.CO.	FOLIO/SHEET 10 / 12
N° AFFAIRE / N° PROJECT	170264	
		VARZ





 3, Rue Pierre Curie
 91230 MONTGERON
 Tél. : 01.69.52.47.00 - Fax : 01.69.52.47.01
 e-mail : seguin@automatismes-seguin.fr
 http://www.automatismes-seguin.fr

UTILITES

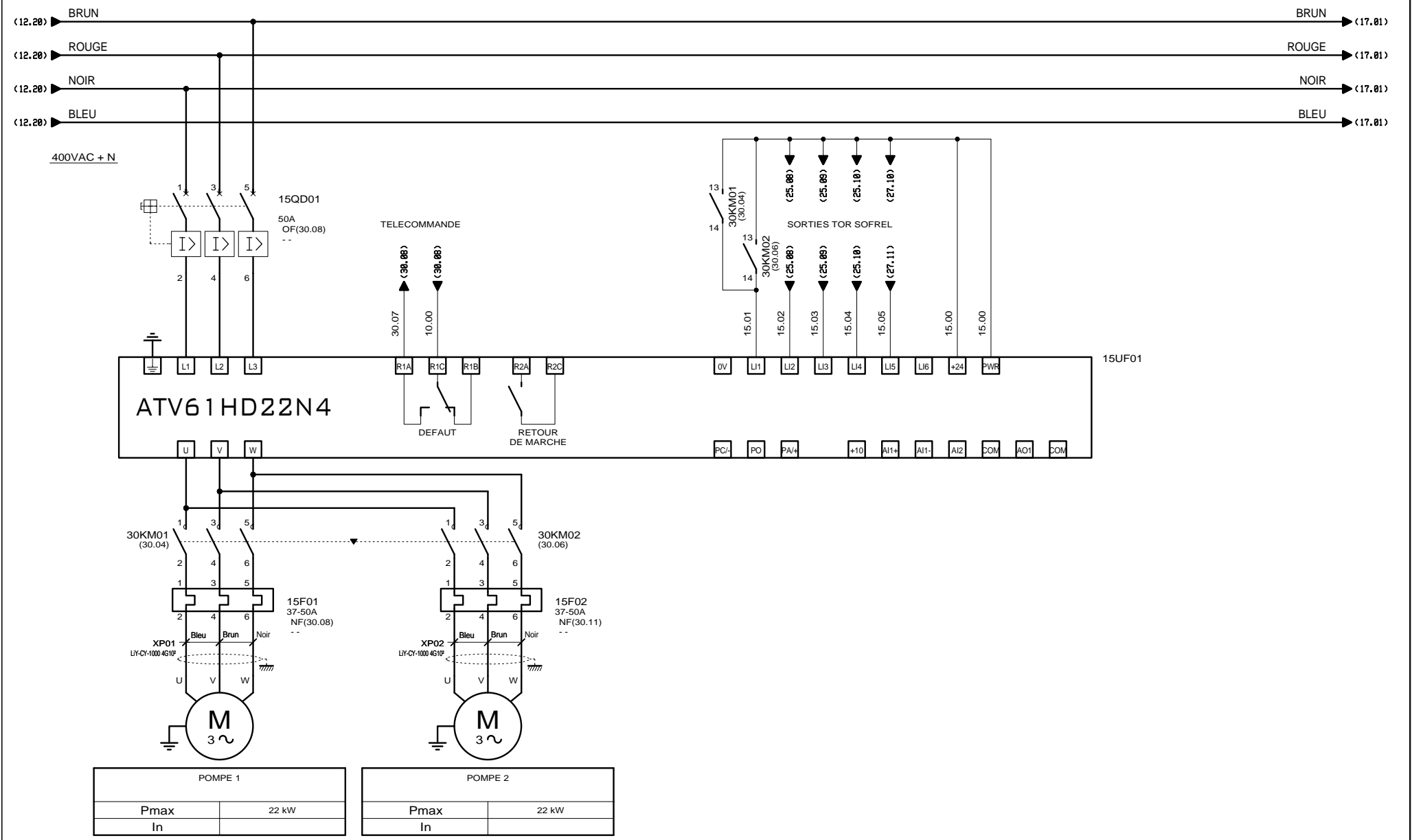
CLIENT ET NOM DU DOSSIER / CUSTOMER AND NAME OF FOLDER		INDICE / REVIEW
SAUR		0
Armoire Saint-Martin-des-Champs		
DESSINATEUR / DRAWER	F.CO.	FOLIO/SHEET 12 / 15
N° AFFAIRE / N° PROJECT	170264	
		V4R2





 3, Rue Pierre Curie
 91230 MONTGERON
 Tél. : 01.69.52.47.00 - Fax : 01.69.52.47.01
 e-mail : seguin@automatismes-seguin.fr
 http://www.automatismes-seguin.fr

PUISSANCE POMPES

POMPE 1	
Pmax	22 kW
In	

POMPE 2	
Pmax	22 kW
In	

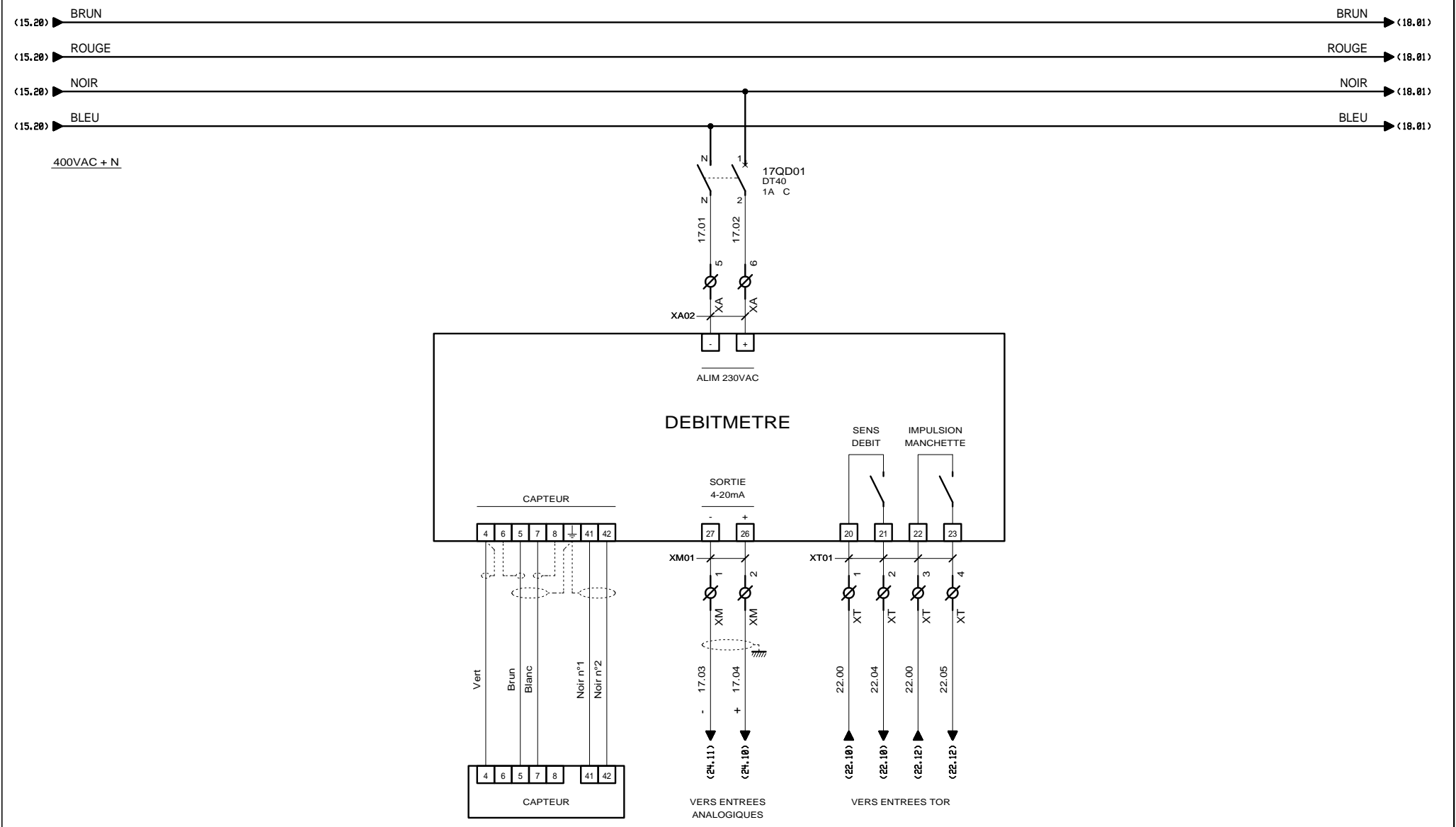
CLIENT ET NOM DU DOSSIER / CUSTOMER AND NAME OF FOLDER		INDICE / REVIEW
SAUR		O
Armoire Saint-Martin-des-Champs		
DESSINATEUR / DRAWER	F.CO.	IGE-XAO
N° AFFAIRE / N° PROJECT	170264	
FOLIO/SHEET 15 / 17		VAR2



MESURE DE DEBIT
SAINT LUBIN

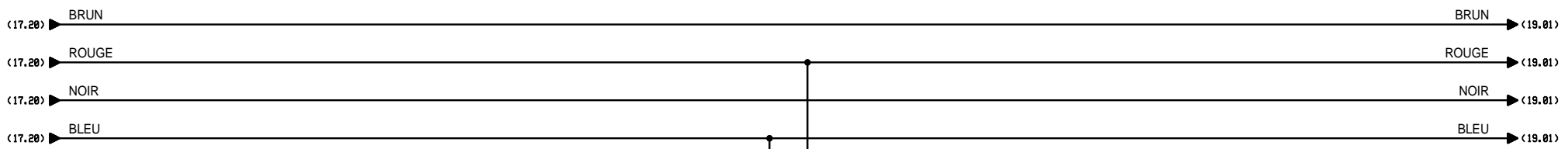

400VAC + N

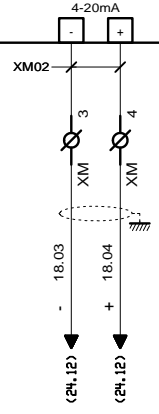
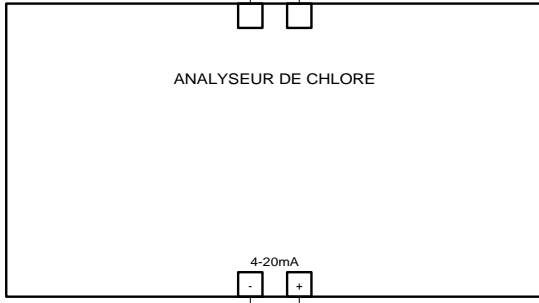
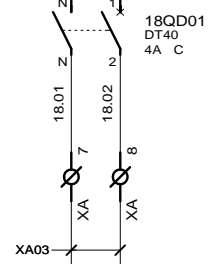

VERS ENTREES ANALOGIQUES



3, Rue Pierre Curie
91230 MONTGERON
Tél. : 01.69.52.47.00 - Fax : 01.69.52.47.01
e-mail : seguin@automatismes-seguin.fr
http://www.automatismes-seguin.fr

ANALYSE DE CHLORE

CLIENT ET NOM DU DOSSIER / CUSTOMER AND NAME OF FOLDER		INDICE / REVIEW
SAUR		0
Armoire Saint-Martin-des-Champs		
DESSINATEUR / DRAWER	F.CO.	FOLIO/SHEET 18 / 19
N° AFFAIRE / N° PROJECT	170264	
		V4R2

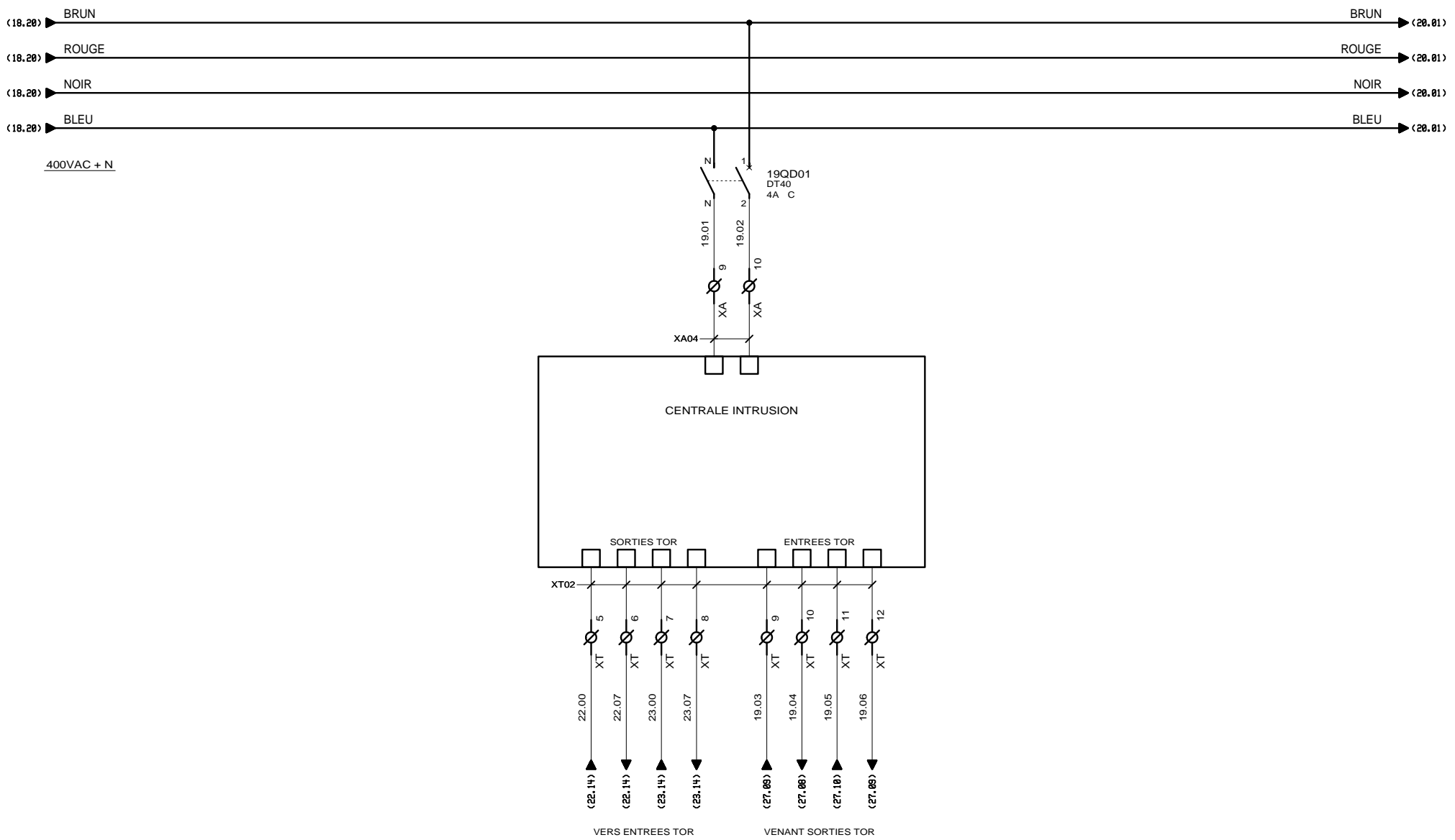



 3, Rue Pierre Curie
 91230 MONTGERON
 Tél. : 01.69.52.47.00 - Fax : 01.69.52.47.01
 e-mail : seguin@automatismes-seguin.fr
 http://www.automatismes-seguin.fr

CENTRALE INTRUSION

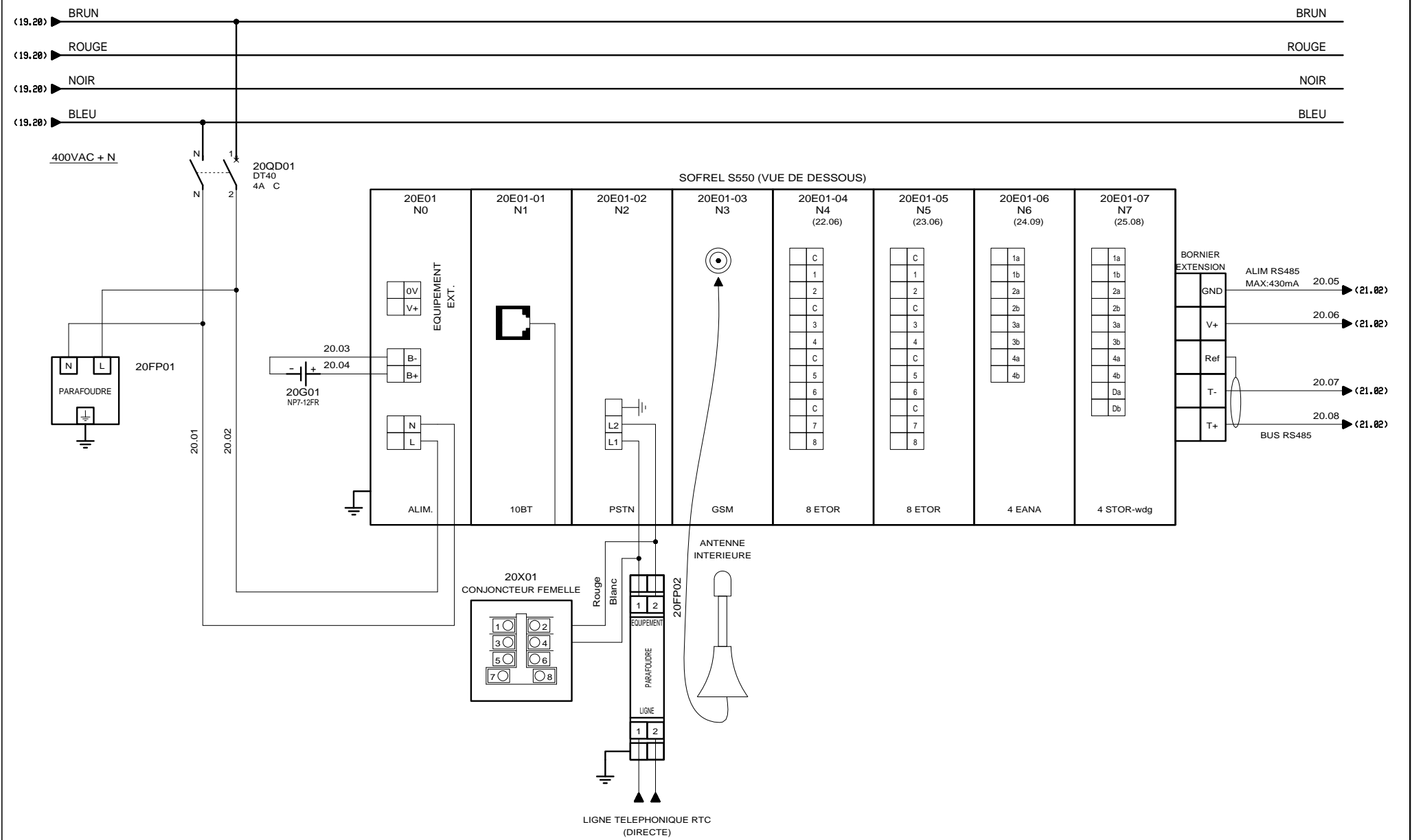
CLIENT ET NOM DU DOSSIER / CUSTOMER AND NAME OF FOLDER		INDICE / REVIEW
SAUR		0
Armoire Saint-Martin-des-Champs		 VARZ
DESSINATEUR / DRAWER	F.CO.	
N° AFFAIRE / N° PROJECT	170264	
FOLIO/SHEET		19 / 20

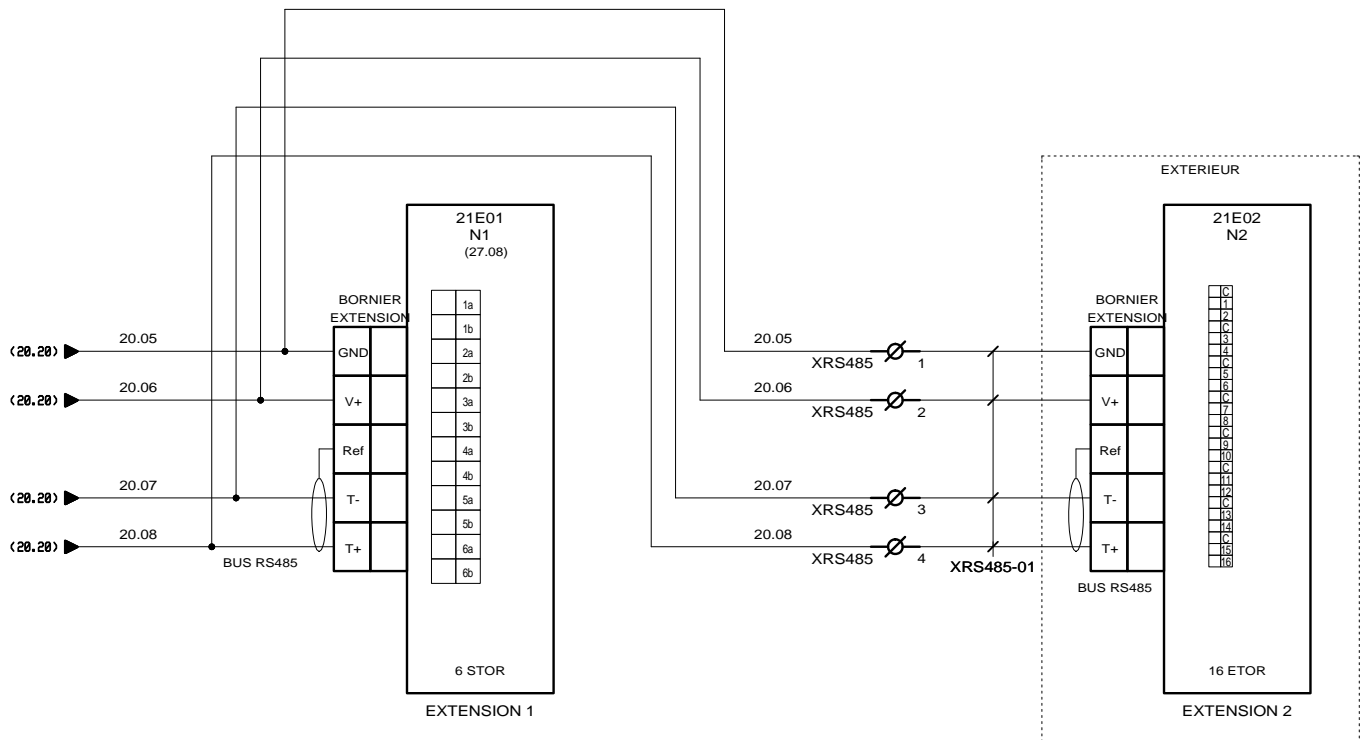



3, Rue Pierre Curie
 91230 MONTGERON
 Tél. : 01.69.52.47.00 - Fax : 01.69.52.47.01
 e-mail : seguin@automatismes-seguin.fr
 http://www.automatismes-seguin.fr

EXTENSIONS SOFREL S550

CLIENT ET NOM DU DOSSIER / CUSTOMER AND NAME OF FOLDER		INDICE / REVIEW
SAUR		0
Armoire Saint-Martin-des-Champs		
DESSINATEUR / DRAWER	F.CO.	FOLIO/SHEET 21/22
N° AFFAIRE / N° PROJECT	170264	
		V4R2

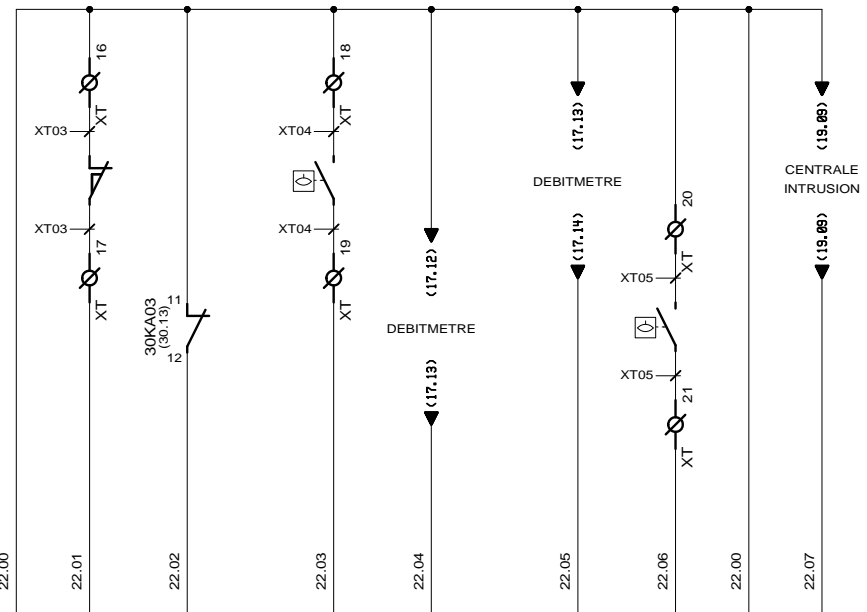

BORNIER	C	1	2	C	3	4	C	5	6	C	7	8
VOIES		1	2		3	4		5	6		7	8
DESIGNATION		(COMMUN VOIES 1 ET 2)	INTRUSION RESERVOIR	NIVEAU TRES BAS RESERVOIR	(COMMUN VOIES 3 ET 4)	POIRE POMPAGE ROSAY	SENS DEBIT SAINT LUBIN	(COMMUN VOIES 5 ET 6)	IMPULSION MANCHETTE SAINT LUBIN	POIRE COMMANDE POMPAGE SAINT LUBIN	(COMMUN VOIES 7 ET 8)	ETAT ALARME INTRUSION
CARTE 8 ETOR SOFREL S550												

20E01-04
(20.11)



3, Rue Pierre Curie
91230 MONTGERON
Tél. : 01.69.52.47.00 - Fax : 01.69.52.47.01
e-mail : seguin@automatismes-seguin.fr
http://www.automatismes-seguin.fr

CARTE 8 ENTrees TOR EMPLACEMENT 4

CLIENT ET NOM DU DOSSIER / CUSTOMER AND NAME OF FOLDER		INDICE / REVIEW
SAUR Armoire Saint-Martin-des-Champs		0
DESSINATEUR DRAWER	F.CO.	IGE XAO
N° AFFAIRE N° PROJECT	170264	
FOLIO/SHEET		22 / 23
		VARZ

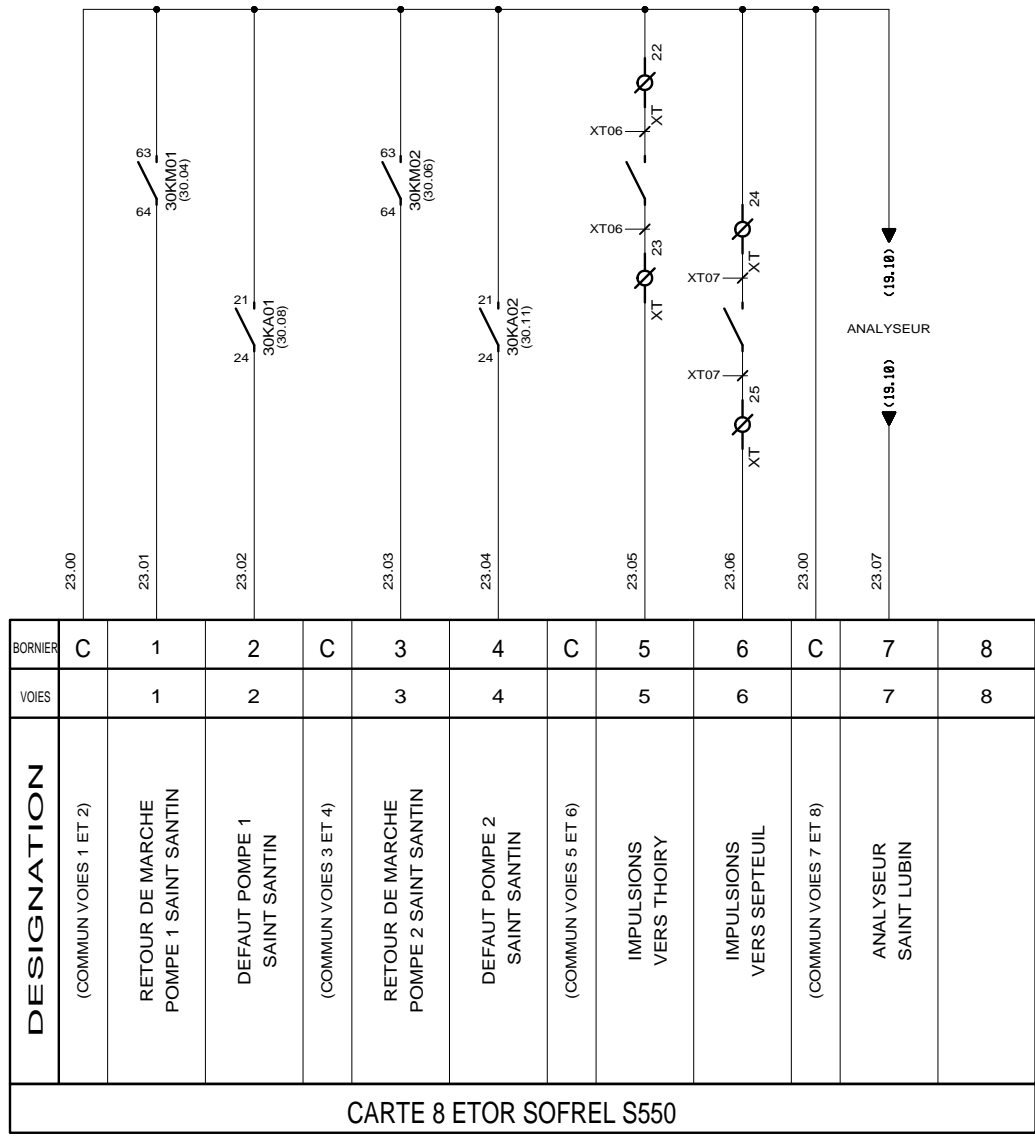

20E01-05
(20.13)



3, Rue Pierre Curie
91230 MONTGERON
Tél. : 01.69.52.47.00 - Fax : 01.69.52.47.01
e-mail : seguin@automatismes-seguin.fr
http://www.automatismes-seguin.fr

CARTE 8 ENTRES TOR EMPLACEMENT 5

CLIENT ET NOM DU DOSSIER / CUSTOMER AND NAME OF FOLDER		INDICE / REVIEW
SAUR		0
Armoire Saint-Martin-des-Champs		IGE XAO
DESSINATEUR DRAWER	F.CO.	FOLIO/SHEET 23 / 24
N° AFFAIRE N° PROJECT	170264	VAR2

RACCORDEMENT :
POUR CAPTEUR AUTONOME

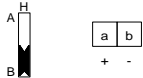

RACCORDEMENT :
POUR CAPTEUR TELEALIMENTE

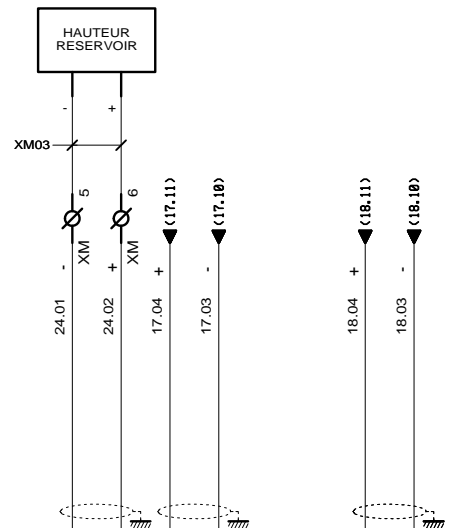
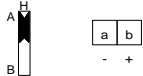

20E01-06
(20.14)

BORNIER	1a	1b	2a	2b	3a	3b	4a	4b
VOIES	1		2		3		4	
DESIGNATION	MESURE DE HAUTEUR RESERVOIR		MESURE DE DEBIT SAINT LUBIN				MESURE DE CHLORE SAINT LUBIN	
CARTE 4 EANA SOFREL S550								



3, Rue Pierre Curie
91230 MONTGERON
Tél. : 01.69.52.47.00 - Fax : 01.69.52.47.01
e-mail : seguin@automatismes-seguin.fr
http://www.automatismes-seguin.fr

CARTE 4 ENTREES ANALOGIQUES EMPLACEMENT 6

CLIENT ET NOM DU DOSSIER / CUSTOMER AND NAME OF FOLDER		INDICE / REVIEW
SAUR Armoire Saint-Martin-des-Champs		0
DESSINATEUR DRAWER	F.CO.	FOLIO/SHEET 24 / 25
N° AFFAIRE N° PROJECT	170264	
		V4R2

CARTE 4 STOR-wdg SOFREL S550										
DESIGNATION	COMMANDE POMPAGE 34Hz		COMMANDE POMPAGE 38Hz		COMMANDE POMPAGE 43Hz				CHIEN DE GARDE	
VOIES	1		2		3		4		5	
BORNIER	1a	1b	2a	2b	3a	3b	4a	4b	Da	Db

20E01-07
(20.16)

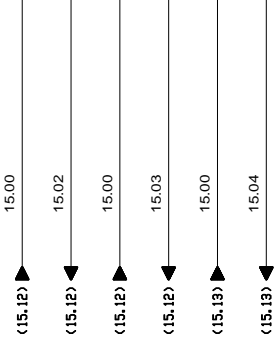

3, Rue Pierre Curie
91230 MONTGERON
Tél. : 01.69.52.47.00 - Fax : 01.69.52.47.01
e-mail : seguin@automatismes-seguin.fr
http://www.automatismes-seguin.fr

**CARTE 4 SORTIES TOR
EMPLACEMENT 7**

CLIENT ET NOM DU DOSSIER / CUSTOMER AND NAME OF FOLDER			INDICE / REVIEW	
SAUR			0	
Armoire Saint-Martin-des-Champs				
DESSINATEUR DRAWER	F.CO.	FOLIO/SHEET		25 / 27
N° AFFAIRE N° PROJECT	170264			V4R2

CARTE 6 STOR SOFREL S550												
DESIGNATION	MISE EN SERVICE INTRUSION		MISE HORS SERVICE INTRUSION		REARMEMENT DEFAULTS		VANNE RETOUR SAINT SANTIN		COMMANDE POMPE 1		COMMANDE POMPE 2	
	1		2		3		4		5		6	
VOIES	1		2		3		4		5		6	
BORNIER	1a	1b	2a	2b	3a	3b	4a	4b	5a	5b	6a	6b

21E01
(21.06)

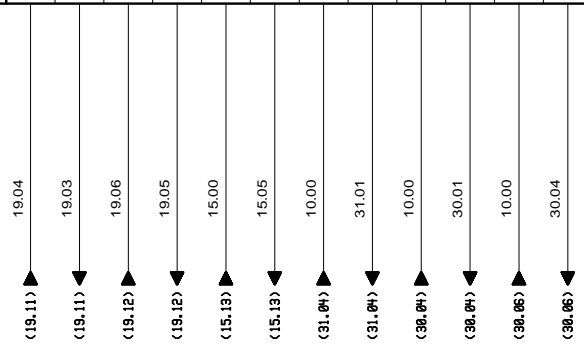

**CARTE 6 SORTIES TOR
EXTENSION 1**

CLIENT ET NOM DU DOSSIER / CUSTOMER AND NAME OF FOLDER		INDICE / REVIEW
SAUR Armoire Saint-Martin-des-Champs		0
DESSINATEUR DRAWER	F.CO.	IGE-XAO
N° AFFAIRE N° PROJECT	170264	
FOLIO/SHEET 27 / 30		VAR2

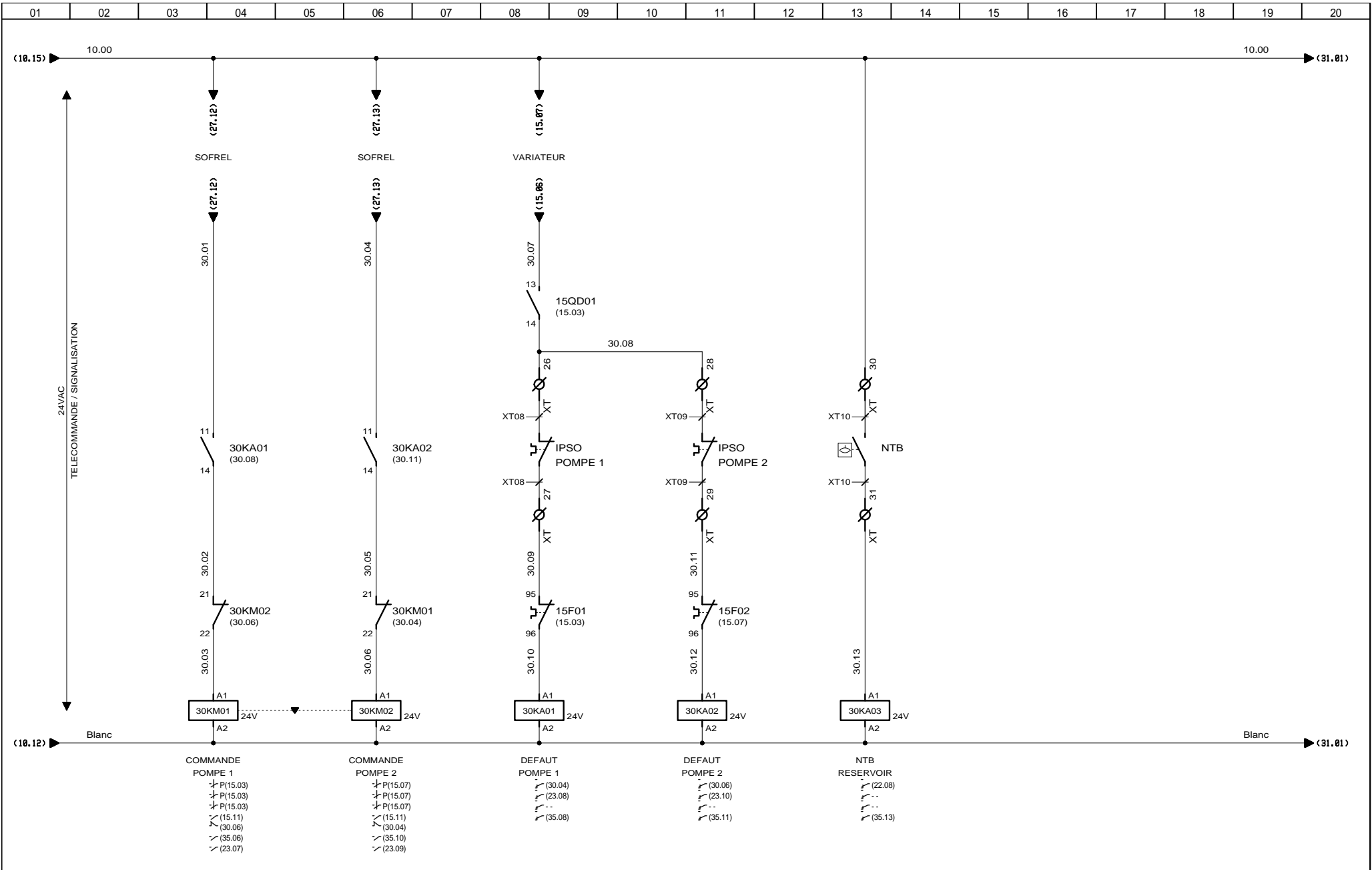

AUTOMATISMES SEGUIN
Systeme Qualité

3, Rue Pierre Curie
91230 MONTGERON
Tél. : 01.69.52.47.00 - Fax : 01.69.52.47.01
e-mail : seguin@automatismes-seguin.fr
http://www.automatismes-seguin.fr

TELECOMMANDE

CLIENT ET NOM DU DOSSIER / CUSTOMER AND NAME OF FOLDER		INDICE / REVIEW
SAUR		O
Armoire Saint-Martin-des-Champs		IGE-XAO
DESSINATEUR / DRAWER	F.CO.	
N° AFFAIRE / N° PROJECT	170264	
FOLIO/SHEET	30 / 31	V4R2



 3, Rue Pierre Curie
 91230 MONTGERON
 Tél. : 01.69.52.47.00 - Fax : 01.69.52.47.01
 e-mail : seguin@automatismes-seguin.fr
<http://www.automatismes-seguin.fr>

TELECOMMANDE

CLIENT ET NOM DU DOSSIER / CUSTOMER AND NAME OF FOLDER		INDICE / REVIEW
SAUR		0
Armoire Saint-Martin-des-Champs		
DESSINATEUR DRAWER	F.CO.	FOLIO/SHEET 31 / 35
N° AFFAIRE N° PROJECT	170264	V4R2

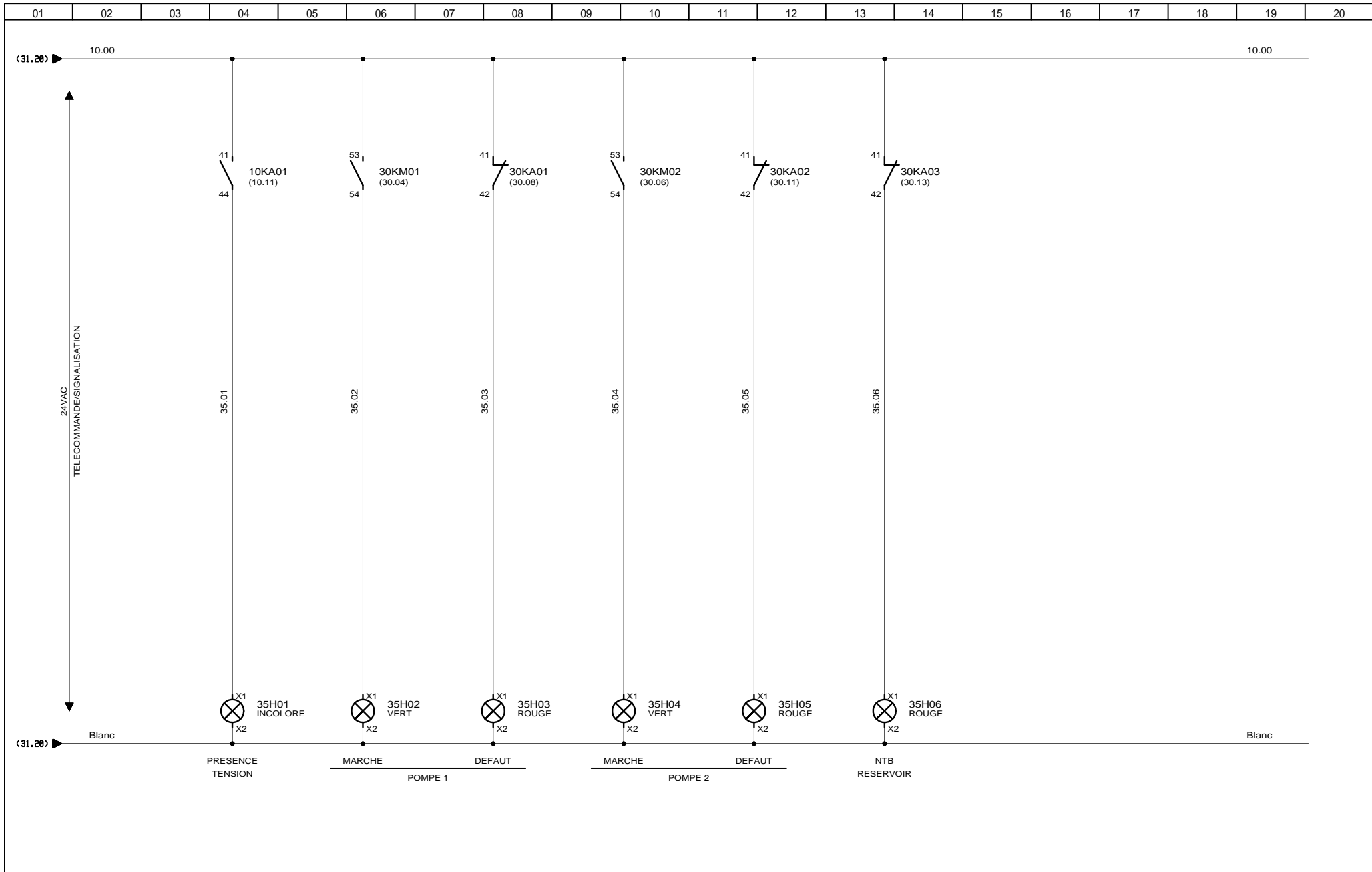

3, Rue Pierre Curie
91230 MONTGERON
Tél. : 01.69.52.47.00 - Fax : 01.69.52.47.01
e-mail : seguin@automatismes-seguin.fr
<http://www.automatismes-seguin.fr>

SIGNALISATION

CLIENT ET NOM DU DOSSIER / CUSTOMER AND NAME OF FOLDER		INDICE / REVIEW
SAUR		0
Armoire Saint-Martin-des-Champs		
DESSINATEUR DRAWER	F.CO.	IGE-XAO
N° AFFAIRE N° PROJECT	170264	FOLIO/SHEET 35 / 40
		V4R2

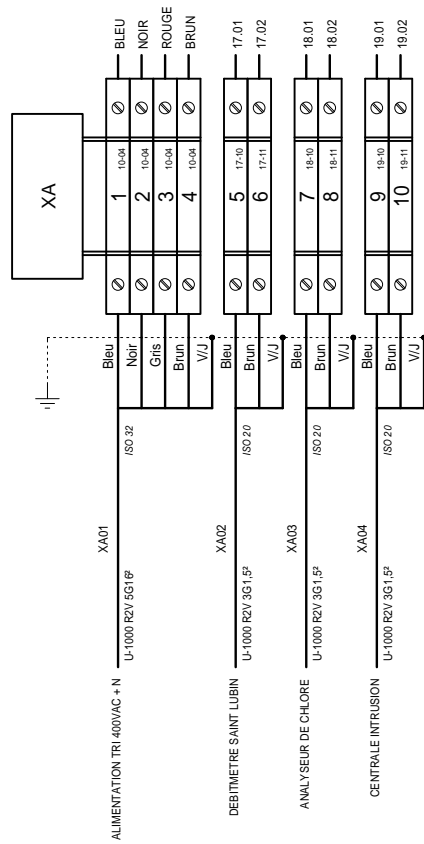

3, Rue Pierre Curie
91230 MONTGERON
Tél. : 01.69.52.47.00 - Fax : 01.69.52.47.01
e-mail : seguin@automatismes-seguin.fr
http://www.automatismes-seguin.fr

BORNIER XA ALIMENTATION

CLIENT ET NOM DU DOSSIER / CUSTOMER AND NAME OF FOLDER		INDICE / REVIEW
SAUR		0
Armoire Saint-Martin-des-Champs		
DESSINATEUR / DRAWER	F.CO.	
N° AFFAIRE / N° PROJECT	170264	FOLIO/SHEET 40 / 41
		V4R2

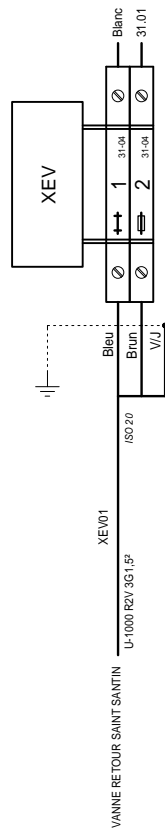

3, Rue Pierre Curie
91230 MONTGERON
Tél. : 01.69.52.47.00 - Fax : 01.69.52.47.01
e-mail : seguin@automatismes-seguin.fr
<http://www.automatismes-seguin.fr>

BORNIER XEV ELECTROVANNES

CLIENT ET NOM DU DOSSIER / CUSTOMER AND NAME OF FOLDER		INDICE / REVIEW
SAUR		0
Armoire Saint-Martin-des-Champs		
DESSINATEUR DRAWER	F.CO.	
N° AFFAIRE N° PROJECT	170264	FOLIO/SHEET 41 / 42
		V4R2

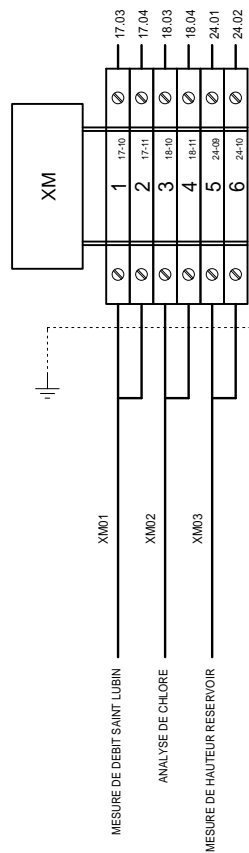

3, Rue Pierre Curie
91230 MONTGERON
Tél. : 01.69.52.47.00 - Fax : 01.69.52.47.01
e-mail : seguin@automatismes-seguin.fr
http://www.automatismes-seguin.fr

BORNIER XM MESURE

CLIENT ET NOM DU DOSSIER / CUSTOMER AND NAME OF FOLDER		INDICE / REVIEW
SAUR		0
Armoire Saint-Martin-des-Champs		
DESSINATEUR DRAWER	F.CO.	FOLIO/SHEET 43 / 44
N° AFFAIRE N° PROJECT	170264	
		V4R2

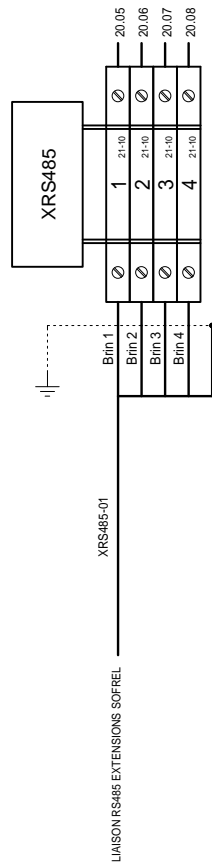

3, Rue Pierre Curie
91230 MONTGERON
Tél. : 01.69.52.47.00 - Fax : 01.69.52.47.01
e-mail : seguin@automatismes-seguin.fr
http://www.automatismes-seguin.fr

BORNIER XRS485 LIAISON RS485

CLIENT ET NOM DU DOSSIER / CUSTOMER AND NAME OF FOLDER		INDICE / REVIEW
SAUR Armoire Saint-Martin-des-Champs		0
DESSINATEUR DRAWER	F.CO.	IGE XAO
N° AFFAIRE N° PROJECT	170264	
FOLIO/SHEET 44 / 50		V4R2

REPERE	DESIGNATION	REFERENCE	MARQUE	QTE
TOLERIE	COFFRET UNIVERSEL AVEC PORTE PLEINE SANS CHASSIS 1200x1000x300, IP66, RAL7035	NSYS3D121030	SCHNEIDER ELECTRIC	1
	POCHETTE OUVERTE POUR PLANS AUTOCOLLANTE, 340x235mm (ACC D'ENVELOPPES)	036580	LEGRAND	1
	POIGNEE A CLE 1242E	NSYAEDL1242S3D	SCHNEIDER ELECTRIC	1
	JEU 4 PATTES DE FIXATION MURALE EN ACIER + CACHES	NSYAEFPFSC2	SCHNEIDER ELECTRIC	1
10E01	REPARTITEUR TETRAPOLAIRE TD 80/100 ALL, 14 CONNEXIONS	563940	ERICO	1
10KA01	RELAIS INDUSTRIEL EMBROCHABLE, MONOSTABLE, 4INV, 24VAC + EMBASE	RMIA4524AC + ZMI4SA	CARLO GAVAZZI	1
10PF01	RELAIS DE CONTROLE TRIPHASÉ POUR L'ORDRE ET LA PERTE DE PHASES, 208-480VAC, 1INV	DPA51CM44	CARLO GAVAZZI	1
10QD01	DISJONCTEUR IC60N 3P 1A, 440VAC/25kA, 133VDC/6kA, COURBE C	A9F74301	SCHNEIDER ELECTRIC	1
10QD02	DISJONCTEUR IC60N 2P 2A, 440VAC/25kA, 133VDC/6kA, COURBE C	A9F74202	SCHNEIDER ELECTRIC	1
10QD03	DISJONCTEUR DT40 1P+N 4A 6kA, COURBE C	A9N21022	SCHNEIDER ELECTRIC	1
10QIG01	INTERRUPTEUR DIFFERENTIEL IID TYPE AC 415VAC 4P 63A 300mA	A9R14463	SCHNEIDER ELECTRIC	1
10TR01	TRANSFORMATEUR DE COMMANDE ET DE SIGNALISATION MONOPHASEE 230-400V/24-48V, 100VA	044233	LEGRAND	1
12E01	VENTILATEUR A FILTRE 223x223 165m3/h, 230VAC, RAL7035	NSYCVF165M230PF	SCHNEIDER ELECTRIC	1
	GRILLE DE SORTIE POUR VENTILATEUR 223x223, RAL7035	NSYCAG223LPF	SCHNEIDER ELECTRIC	1
12ECH01	RESISTANCE CHAUFFANTE PTC CS 060, 120-240V AC/DC, 50W	06000.0-00	STEGO	1
12ECL01	LAMPE RENTABLE 8W 220V 50-60Hz 400lm	NSYLAM8T5	SCHNEIDER ELECTRIC	1
12KTH01	PETIT THERMOSTAT KTO 011, 1NF, 0..60°C	01146.9-00	STEGO	1
12KTH02	PETIT THERMOSTAT KTS 011, 1NO, 0..60°C	01147.9-00	STEGO	1
12QD01	DISJONCTEUR DT40 VIGI 1P+N CLASSE AC 16A 30mA COURBE C	A9N21444	SCHNEIDER ELECTRIC	1
12QD02	DISJONCTEUR DT40 1P+N 1A 6kA, COURBE C	A9N21019	SCHNEIDER ELECTRIC	1
12QD03	DISJONCTEUR DT40 1P+N 1A 6kA, COURBE C	A9N21019	SCHNEIDER ELECTRIC	1
12QD04	DISJONCTEUR DT40 1P+N 1A 6kA, COURBE C	A9N21019	SCHNEIDER ELECTRIC	1
12S01	CONTACT DE PORTE	NSYINLCRN	SCHNEIDER ELECTRIC	1
12X01	PRISE DE COURANT 2P+T 10/16A, 250VAC A ECLIPS	004280	LEGRAND	1
15F01	RELAIS DE PROTECTION THERMIQUE 37-50A, RACCORDEMENT PAR CONNECTEURS EVERLINK, A VIS BTR	LRD350	SCHNEIDER ELECTRIC	1
15F02	RELAIS DE PROTECTION THERMIQUE 37-50A, RACCORDEMENT PAR CONNECTEURS EVERLINK, A VIS BTR	LRD350	SCHNEIDER ELECTRIC	1
15QD01	DISJONCTEUR MOTEUR MAGNETIQUE AC3 22kW/415V, 50A	GV3L50	SCHNEIDER ELECTRIC	1
	ADDITIF FRONTAL F+O	GVAE11	SCHNEIDER ELECTRIC	1
15UF01	VARIATEUR DE VITESSE ATV 61 POUR MOTEUR 22kW, 380...480V 50-60Hz TRI	ATV61HD22N4	SCHNEIDER ELECTRIC	1
17QD01	DISJONCTEUR DT40 1P+N 1A 6kA, COURBE C	A9N21019	SCHNEIDER ELECTRIC	1
18QD01	DISJONCTEUR DT40 1P+N 4A 6kA, COURBE C	A9N21022	SCHNEIDER ELECTRIC	1
19QD01	DISJONCTEUR DT40 1P+N 4A 6kA, COURBE C	A9N21022	SCHNEIDER ELECTRIC	1
20E01	RACK S550 8 EMBLEMENTS AVEC ALIM SECTEUR 230VAC	T9950A100	SOFREL	1
20E01-01	MODULE DE COMMUNICATION ETHERNET 10MB	V5900710	SOFREL	1
20E01-02	MODULE DE COMMUNICATION PSTN (RTC) 33.600 bps	V5900510	SOFREL	1
20E01-03	MODULE DE COMMUNICATION GSM + ANTENNE BI-BANDE	V5900520	SOFREL	1
20E01-04	MODULE D'ENTREES, 8E TOR	V5900210	SOFREL	1
20E01-05	MODULE D'ENTREES, 8E TOR	V5900210	SOFREL	1
20E01-06	MODULE D'ENTREES, 4E ANA MULTISTANDARD	V5900250	SOFREL	1
20E01-07	MODULE DE SORTIES, 4S TOR 1S TOR WDG 50V 1A	V5900310	SOFREL	1
20FP01	PROTECTION SECTEUR 230V, 5kA, Up=1.2kV	T5300011	SOFREL	1
20FP02	PROTECTION RTC	T5300012	SOFREL	1
20G01	BATTERIE 12V, 7Ah	NP7-12FR	YUASA	1
20QD01	DISJONCTEUR DT40 1P+N 4A 6kA, COURBE C	A9N21022	SCHNEIDER ELECTRIC	1
20X01	PRISE TELEPHONIQUE SAILLIE - 8 CONTACTS	051219	LEGRAND	1
21E01	MODULE DE SORTIES 6S TOR, EXTENSION I/O	V6900310	SOFREL	1
21E02	MODULE D'ENTREES 16E TOR, EXTENSION I/O	V6900210	SOFREL	1



3, Rue Pierre Curie
91230 MONTGERON
Tél. : 01.69.52.47.00 - Fax : 01.69.52.47.01
e-mail : seguin@automatismes-seguin.fr
http://www.automatismes-seguin.fr

NOMENCLATURE

CLIENT ET NOM DU DOSSIER / CUSTOMER AND NAME OF FOLDER		INDICE / REVIEW
SAUR		0
Armoire Saint-Martin-des-Champs		
DESSINATEUR DRAWER	F.CO.	FOLIO/SHEET 50 / 51
N° AFFAIRE N° PROJECT	170264	
		IGE XAO VAR2

