

16/10/2018	0	M.H.	RETOUR ESSAIS	F.C.	R.M.
03/05/2018	A	M.H.	PREMIERE EMISSION	F.C.	R.M.
DATE	REV.	DESSINE PAR	MODIFICATIONS	VERIFIE PAR	APPROUVE PAR
DATE	REV.	DRAWN BY	REVISIONS	CHECKED BY	APPROVED BY

***SCHEMA ELECTRIQUE
ELECTRICAL DRAWING***



3, Rue Pierre Curie
91230 MONTGERON
Tél. : 01.69.52.47.00 - Fax : 01.69.52.47.01
e-mail : seguin@automatismes-seguin.fr
<http://www.automatismes-seguin.fr>

PLAN: 180137	REV: 0
CDE: 18049723YP00900	

Ce document est notre propriété. Il ne peut être reproduit et / ou communiqué sans autorisation.
This document is our property. It cannot be reproduced and / or transmitted without authorization.



Armoire PR Point P Montereau

LETTRE DE REPERAGE DES ELEMENTS DU SCHEMA

QI	INTERRUPTEUR	PCPI	CONTROLEUR D'ISOLEMENT	KT	RELAIS TEMPORISE	SA	COMMUTATEUR D'AMPEREMETRE
QIG	INTERRUPTEUR GENERAL	TR	TRANSFORMATEUR DE TENSION	KAU	RELAIS ARRET D'URGENCE	SV	COMMUTATEUR DE VOLTMETRE
QD	DISJONCTEUR	TC	TRANSFORMATEUR DE COURANT	UF	VARIATEUR	ECH	RESISTANCE CHAUFFANTE
QDG	DISJONCTEUR GENERAL	U	ONDULEUR, ALIMENTATION	UM	DEMARREUR	ECL	ECLAIRAGE
FP	PARAFONDRE	KIC	INTER CREPUSCULAIRE	S	ORGANE DE COMMANDE	G	BATTERIE
FU	FUSIBLE	KIH	HORLOGE	H	VOYANT, SIRENE	P	INSTRUMENTATION
F	THERMIQUE	KTH	THERMOSTAT	PCH	COMPTEUR HORAIRE	X	PRISE DE COURANT, BORNIER
QF	SECTIONNEUR FUSIBLE	KM	CONTACTEUR	PA	AMPEREMETRE	E	MATERIELS AUTRES
PF	CONTROLEUR DE PHASE	KA	RELAIS	PV	VOLTMETRE	KTL	TELERUPTEUR

LETTER CODES FOR ITEMS DESIGNATION ON THE DRAWING

QI	SWITCH	PCPI	INSULATION CONTROLLER	KT	TEMPORIZES RELAY	SA	AMPEREMETER SWITCH
QIG	GENERAL SWITCH	TR	TENSION TRANSFORMER	KAU	EMERGENCY STOP RELAY	SV	VOLTMETER SWITCH
QD	BREAKER	TC	CURRENT TRANSFORMER	UF	VELOCITY VARIATOR	ECL	LIGHT
QDG	GENERAL BREAKER	U	INVERTER, SUPPLY	UM	MOTOR STARTER	ECH	HEATER
FP	LIGHTNING PROTECTOR	KIC	DIMMER	S	CONTROL UNIT	G	BATTERY
FU	FUSE	KIH	CLOCK	H	INDICATOR	P	INSTRUMENTATION
F	THERMAL RELAY	KTH	THERMOSTAT	PCH	TIMER	X	SOCKET, TERMINAL BLOCK
QF	DISCONNECTING SWITCH	KM	CONTACTOR	PA	AMPEREMETER	E	OTHER EQUIPMENTS
PF	PHASE CONTROLLER	KA	RELAY	PV	VOLTMETER	KTL	TELEBREAKER

COULEURS DE FILS

TRI 400V: <= 6 mm2 Noir Rouge Brun
> 6 mm2 Noir Bagué Noir Rouge Brun

NEUTRE: Bleu Clair

230VAC: Rouge avec Commun Bobines Blanc (*)

230VAC ONDULE: Neutre Bleu Clair Bagué Orange
Phase Noir Bagué Orange

110VAC: Noir avec Commun Bobines Blanc (*)

24VAC: Violet avec Commun Bobines Blanc (*)

24VDC: Bleu Foncé avec Commun Bobines Blanc (*)

48VAC: Violet avec Commun Bobines Blanc (*)

48VDC: Bleu Foncé avec Commun Bobines Blanc (*)

REPORTS: Orange

TERRE: Vert/Jaune

ANALOGIQUE: Une Paire + Brun - Blanc
Unifilaire Blanc

TENSION EXTERNE PERMANENTE INTER GENERAL OUVERT: Orange

ATTENTION

Si plusieurs tensions de télécommande, alors prendre uniquement le 230VAC avec Commun Bobines Blanc

(*) Si Télécommande

WIRE COLOR

TRI 400V: <= 6 mm2 Black Red Brown
> 6 mm2 Black with Ring Black Red Brown

NEUTRE: Light Blue

230VAC: Red with Spods Common White (*)

230VAC UPS: Neutre Light Blue with Ring Orange
Phase Black with Ring Orange

110VAC: Black with Spods Common White (*)

24VAC: Purple with Spods Common White (*)

24VDC: Dark Bleu with Spods Common White (*)

48VAC: Purple with Spods Common White (*)

48VDC: Dark Bleu with Spods Common White (*)

REPORTS: Orange

GROUND: Green/Yellow

ANALOGICAL: One Pair + Brown - White
Unifilar White

PERMANENTLY EXTERNAL POWER GENERAL BREAKER OPEN: Orange

CAUTION

If There are Several Tensions of Command Then to take Only the 230VAC with Spods Common White

(*) If Command

TYPE DE RELAIS ET DE CONTACT DANS LE SCHEMA

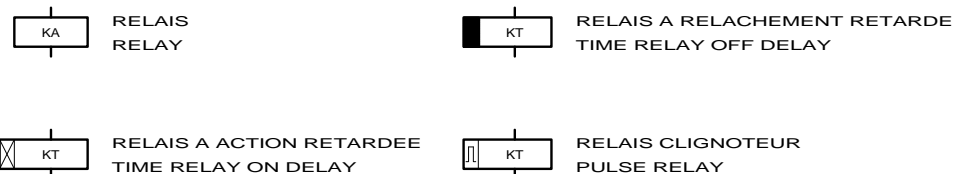

RELAY AND CONTACT TYPE IN THE DRAWING

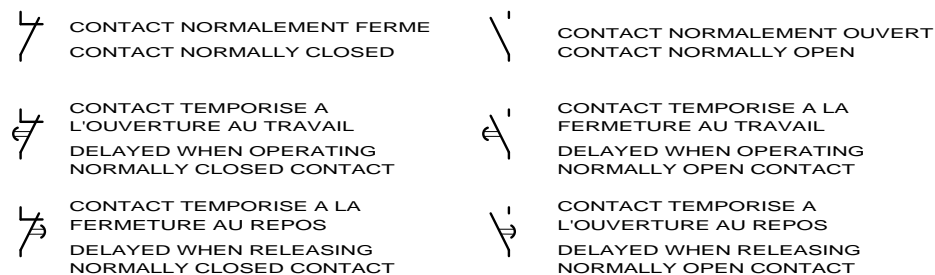

LE SCHEMA EST REPRESENTE HORS TENSION ET GENERATEUR HORS SERVICE

THE DRAWING IS SHOWN OUT OF VOLTAGE AND WITH GENERATOR OUT OF SERVICE



3, Rue Pierre Curie
91230 MONTGERON
Tél. : 01.69.52.47.00 - Fax : 01.69.52.47.01
e-mail : seguin@automatismes-seguin.fr
http://www.automatismes-seguin.fr

LEGENDE DU SCHEMA ELECTRIQUE

CLIENT ET NOM DU DOSSIER / CUSTOMER AND NAME OF FOLDER		INDICE / REVIEW
SAUR		0
Armoire PR Point P Montereau		
DESSINATEUR / DRAWER	M.H.	
N° AFFAIRE / N° PROJECT	180137	
FOLIO/SHEET 03/04		<small>VARZ SERVICE PACK 11 - (A.49.F)</small>

CODE DU REPERAGE

LETTER CODE

1/ DES APPAREILS DANS LES ARMOIRES
APPARATUS IN THE CABINETS



52 KA 01

N° D'ORDRE DANS LE FOLIO D'ORIGINE
ORDER NUMBER ON ORIGINAL SHEET

LETTRE DE REPERAGE
LETTER CODES FOR ITEM

N° DU FOLIO D'ORIGINE
ORIGINAL SHEET NUMBER

2/ DES FILS DE CABLAGE
WIRING

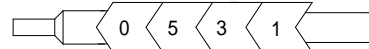

N° DU FOLIO D'ORIGINE
ORIGINAL SHEET NUMBER

N° DU FIL DANS LE FOLIO D'ORIGINE
NUMBER OF THE WIRE ON ORIGINAL SHEET

3/ REPORT DES CONTACTS DANS LE SCHEMA
CONTACT REPORT IN THE DRAWING



17.29

N° DE LA COLONNE OU EST UTILISE LE CONTACT
COLUMN NUMBER WHERE THE CONTACT IS USED

N° DU FOLIO OU EST UTILISE LE CONTACT
SHEET NUMBER WHERE THE CONTACT IS USED

4/ REPRESENTATION DES BORNES ET BORNIERES DANS LE SCHEMA
BINDINGS SCREWS VIEW IN THE DRAWING

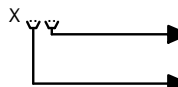

N° D'ORDRE (SI NECESSAIRE)
ORDER NUMBER (IF NECESSARY)

NATURE DU BORNIER
NATURE OF TERMINAL BLOCK

A : ALIMENTATION
P : PUISSANCE
T : TELECOMMANDE
M : MESURE
R : REPORTS



LE SCHEMA EST REPRESENTE HORS TENSION ET GENERATEUR HORS SERVICE

THE DRAWING IS SHOWN OUT OF VOLTAGE AND WITH GENERATOR OUT OF SERVICE



3, Rue Pierre Curie
91230 MONTGERON
Tél. : 01.69.52.47.00 - Fax : 01.69.52.47.01
e-mail : seguin@automatismes-seguin.fr
http://www.automatismes-seguin.fr

LEGENDE DU SCHEMA ELECTRIQUE

CLIENT ET NOM DU DOSSIER / CUSTOMER AND NAME OF FOLDER		INDICE / REVIEW
SAUR		0
Armoire PR Point P Montereau		IGE-XAO
DESSINATEUR DRAWER	M.H.	
N° AFFAIRE N° PROJECT	180137	FOLIO/SHEET 04/05
		VARZ SERVICE PACK.11-(A.49.F)

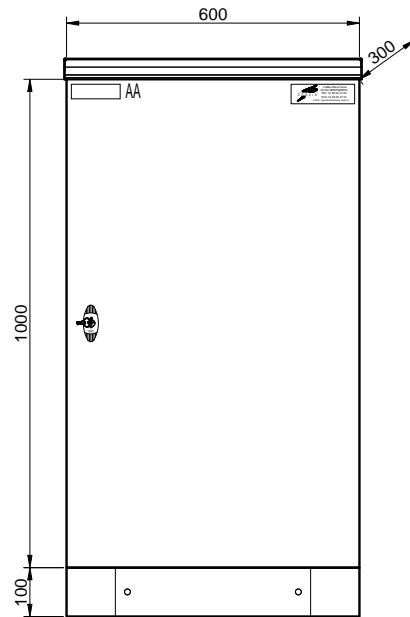

ETIQUETTES 100x30

AA - PR MONTEREAU - POINT P



3, Rue Pierre Curie
91230 MONTGERON
Tél. : 01.69.52.47.00 - Fax : 01.69.52.47.01
e-mail : seguin@automatismes-seguin.fr
http://www.automatismes-seguin.fr

IMPLANTATION FACADE

CLIENT ET NOM DU DOSSIER / CUSTOMER AND NAME OF FOLDER		INDICE / REVIEW
SAUR Armoire PR Point P Montereau		0
DESSINATEUR DRAWER	M.H.	FOLIO/SHEET 05 / 06
N° AFFAIRE N° PROJECT	180137	
		IGE XAO VARZ SERVICE PACK.11-(4.49.F)

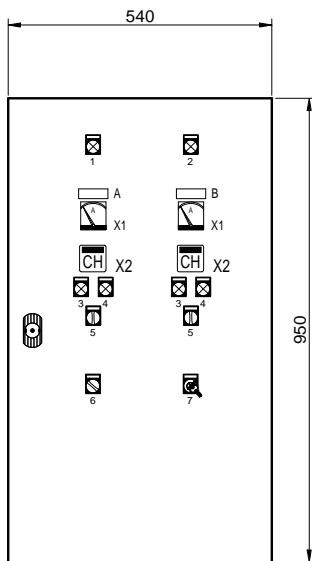

PORTE INTERIEURE

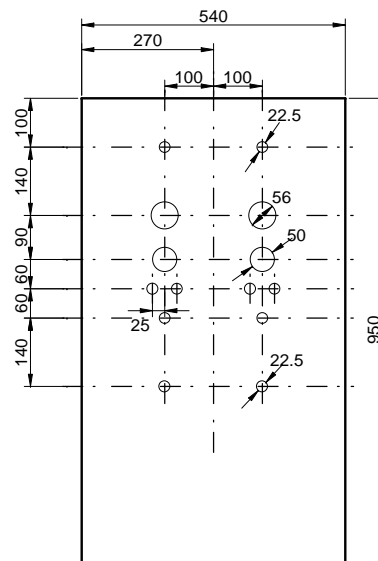

PLAN DE DECOUPE
PORTE INTERIEURE

ETIQUETTES 60x20

- A - POMPE 1
- B - POMPE 2

ETIQUETTES SCHNEIDER

- 1 - SOUS TENSION
- 2 - NIVEAU TROP PLEIN
- 3 - MARCHE
- 4 - DEFAULT
- 5 - AUTO / 0 / MAIN
- 6 - NORMAL / DEGRADE
- 7 - NORMAL / INTERVENTION

DIVERS

- X1 - AMPEREMETRE
- X2 - COMPTEUR HORAIRE



3, Rue Pierre Curie
91230 MONTGERON
Tél. : 01.69.52.47.00 - Fax : 01.69.52.47.01
e-mail : seguin@automatismes-seguin.fr
http://www.automatismes-seguin.fr

IMPLANTATION PLATINE INTERIEURE

CLIENT ET NOM DU DOSSIER / CUSTOMER AND NAME OF FOLDER		INDICE / REVIEW
SAUR		0
Armoire PR Point P Montereau		IGE-XAO
DESSINATEUR DRAWER	M.H.	FOLIO/SHEET 06 / 10
N° AFFAIRE N° PROJECT	180137	<small>VARZ SERVICE PACK.11-(A.49.F)</small>

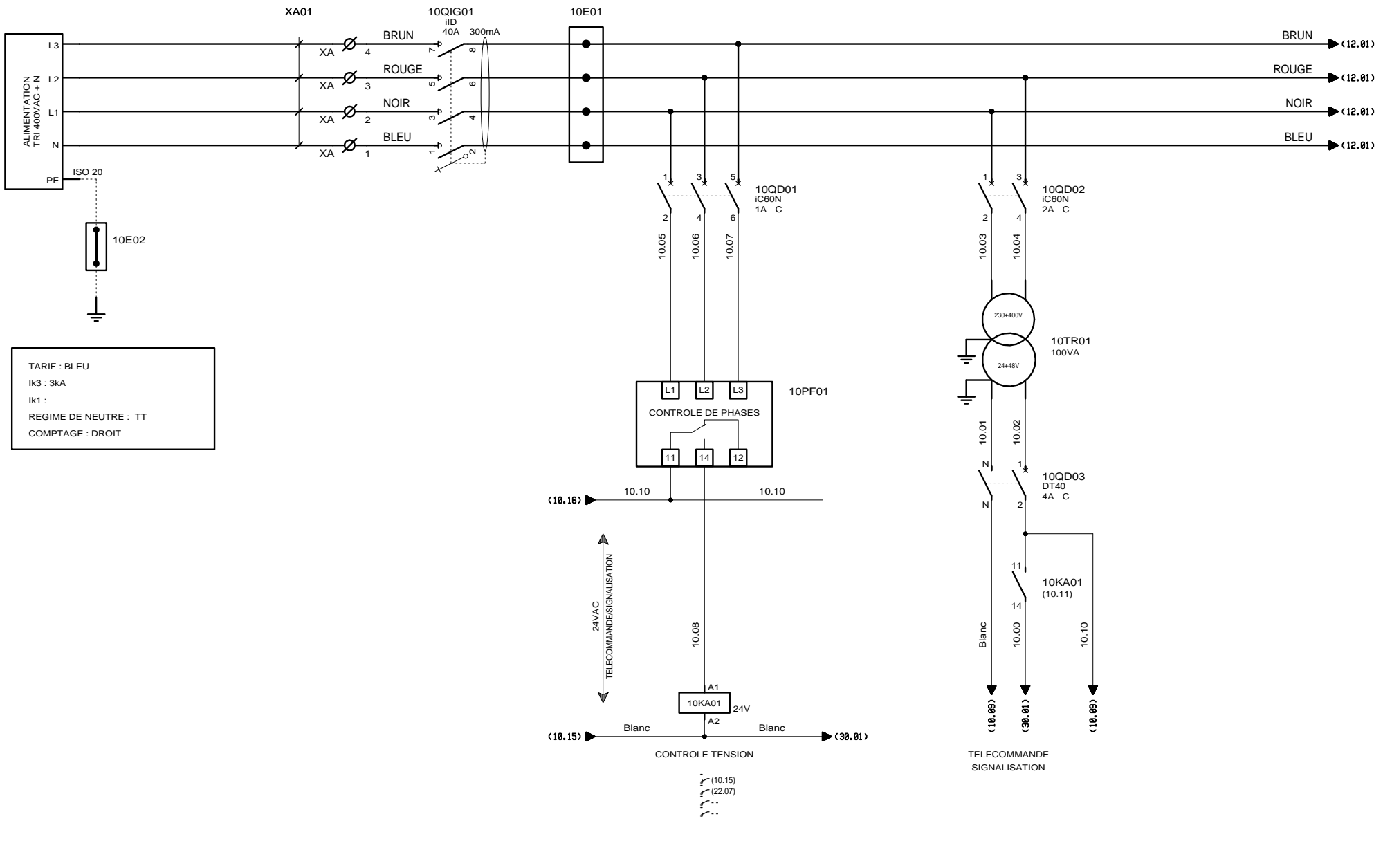

TARIF : BLEU
 Ik3 : 3kA
 Ik1 :
 REGIME DE NEUTRE : TT
 COMPTAGE : DROIT

ARRIVEE GENERALE

AUTOMATISMES SEGUIN
 Systeme Qualité

3, Rue Pierre Curie
 91230 MONTGERON
 Tél. : 01.69.52.47.00 - Fax : 01.69.52.47.01
 e-mail : seguin@automatismes-seguin.fr
 http://www.automatismes-seguin.fr

CLIENT ET NOM DU DOSSIER / CUSTOMER AND NAME OF FOLDER		INDICE / REVIEW
SAUR		0
Armoire PR Point P Montereau		IGE-XAO
DESSINATEUR / DRAWER	M.H.	
N° AFFAIRE / N° PROJECT	180137	
FOLIO/SHEET 10 / 12		VARZ SERVICE PACK.11-(A.49.F)

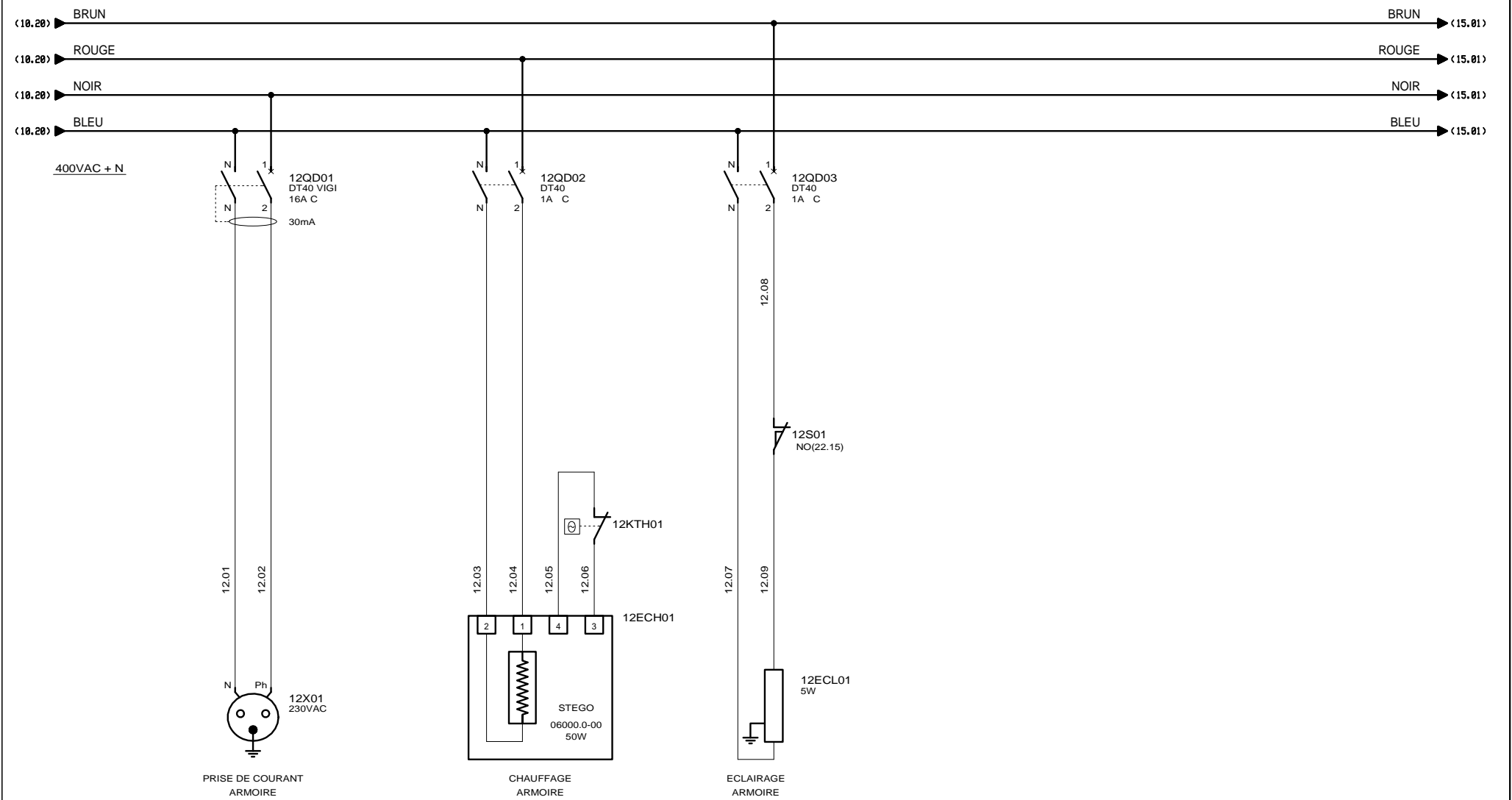

AUTOMATISMES SEGUIN
 Systeme Qualité

3, Rue Pierre Curie
 91230 MONTGERON
 Tél. : 01.69.52.47.00 - Fax : 01.69.52.47.01
 e-mail : seguin@automatismes-seguin.fr
 http://www.automatismes-seguin.fr

DISTRIBUTION 400VAC + N UTILITES

CLIENT ET NOM DU DOSSIER / CUSTOMER AND NAME OF FOLDER		INDICE / REVIEW
SAUR		0
Armoire PR Point P Montereau		IGE-XAO VARZ SERVICE PACK.11-(4.49.F)
DESSINATEUR DRAWER	M.H.	
N° AFFAIRE N° PROJECT	180137	
FOLIO/SHEET 12 / 15		

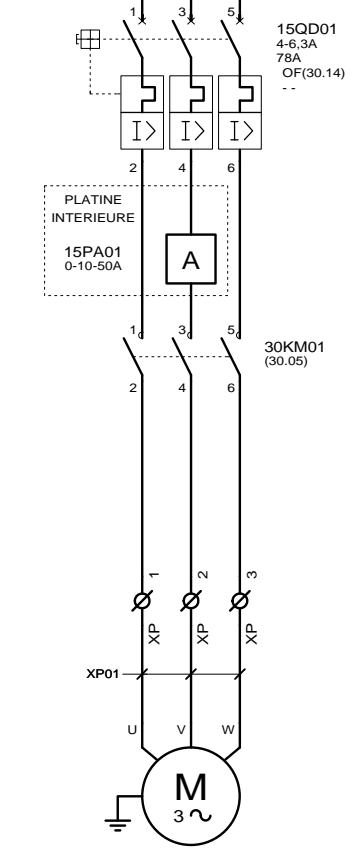
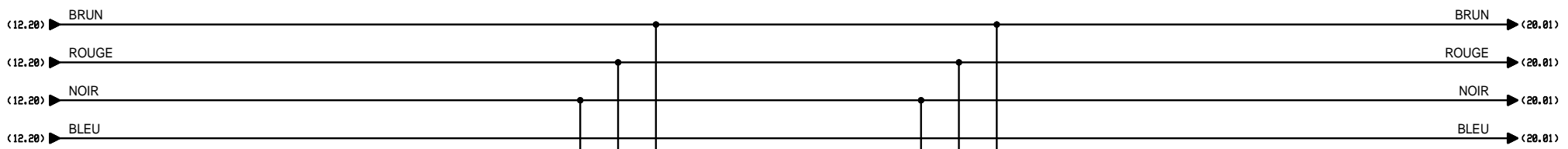

POMPE 1	
Pmax	* kW
In	* A

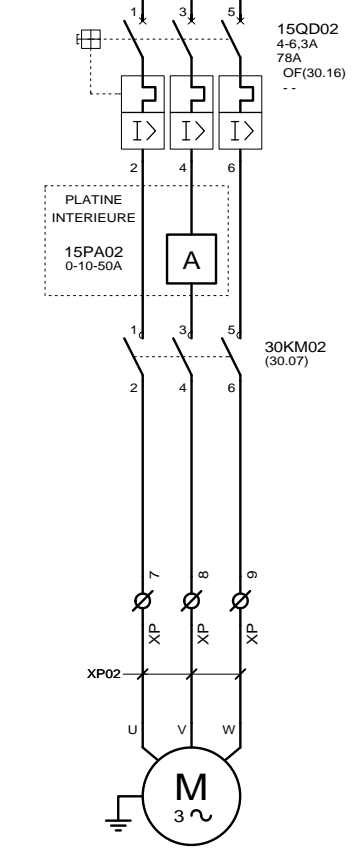

POMPE 2	
Pmax	* kW
In	* A

AUTOMATISMES SEGUIN
 Systeme Qualité

3, Rue Pierre Curie
 91230 MONTGERON
 Tél. : 01.69.52.47.00 - Fax : 01.69.52.47.01
 e-mail : seguin@automatismes-seguin.fr
 http://www.automatismes-seguin.fr

PUISSANCE POMPES

CLIENT ET NOM DU DOSSIER / CUSTOMER AND NAME OF FOLDER		INDICE / REVIEW
SAUR		0
Armoire PR Point P Montereau		IGE-XAO
DESSINATEUR / DRAWER	M.H.	
N° AFFAIRE / N° PROJECT	180137	
FOLIO/SHEET	15 / 20	VARZ SERVICE PACK.11-(4.49.F)

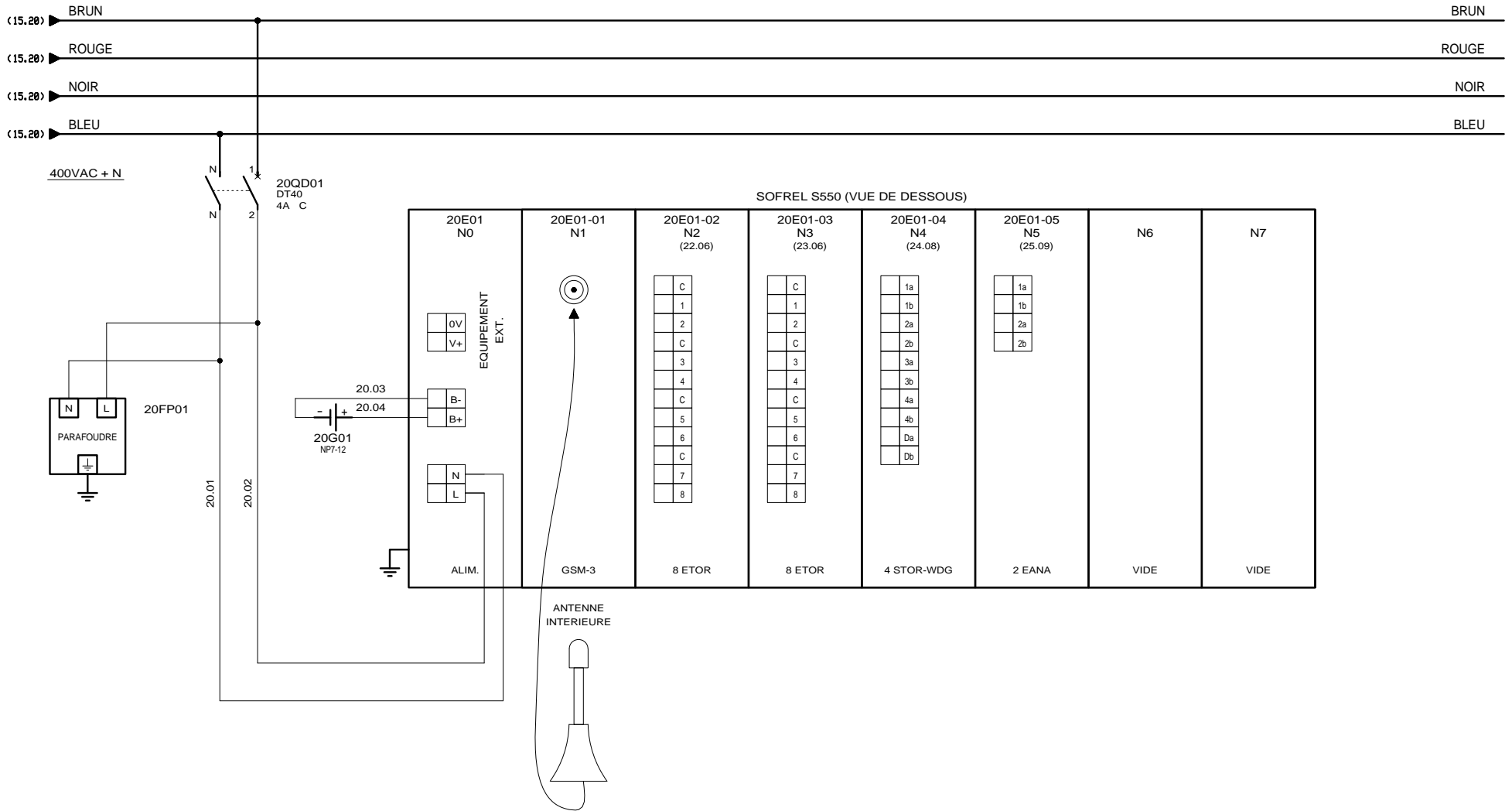

 3, Rue Pierre Curie
 91230 MONTGERON
 Tél. : 01.69.52.47.00 - Fax : 01.69.52.47.01
 e-mail : seguin@automatismes-seguin.fr
 http://www.automatismes-seguin.fr

ALIMENTATION SOFREL S550

CLIENT ET NOM DU DOSSIER / CUSTOMER AND NAME OF FOLDER		INDICE / REVIEW
SAUR		0
Armoire PR Point P Montereau		
DESSINATEUR / DRAWER	M.H.	FOLIO/SHEET 20 / 22
N° AFFAIRE / N° PROJECT	180137	
		 <small>VARZ SERVICE PACK.11-(A.49.F)</small>

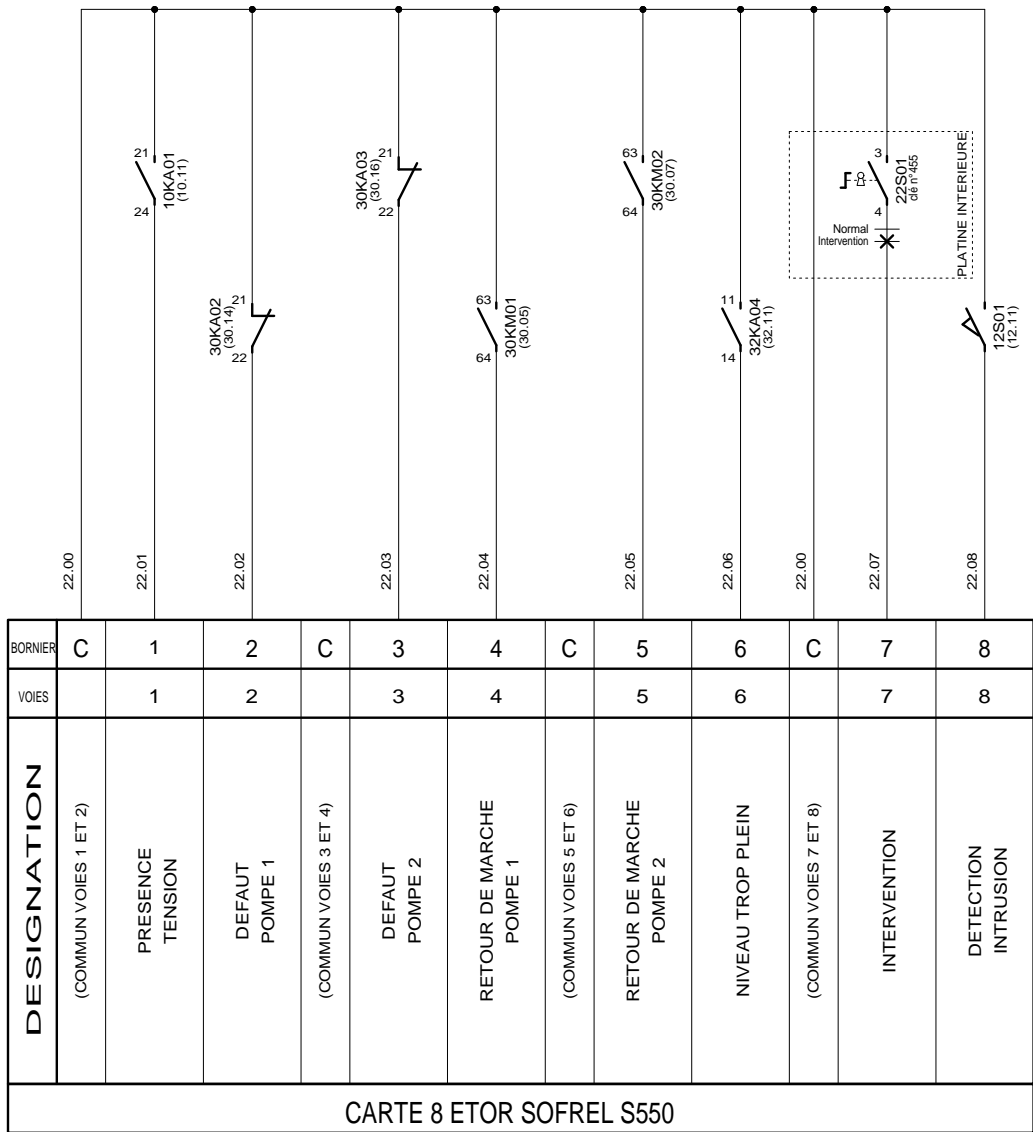

20E01-02
(20.09)

CARTE 8 ENTrees TOR EMPLACEMENT 2

CLIENT ET NOM DU DOSSIER / CUSTOMER AND NAME OF FOLDER		INDICE / REVIEW
SAUR		0
Armoire PR Point P Montereau		IGE-XAO
DESSINATEUR DRAWER	M.H.	FOLIO/SHEET 22 / 23
N° AFFAIRE N° PROJECT	180137	VARZ SERVICE PACK.11-(A.49.F)

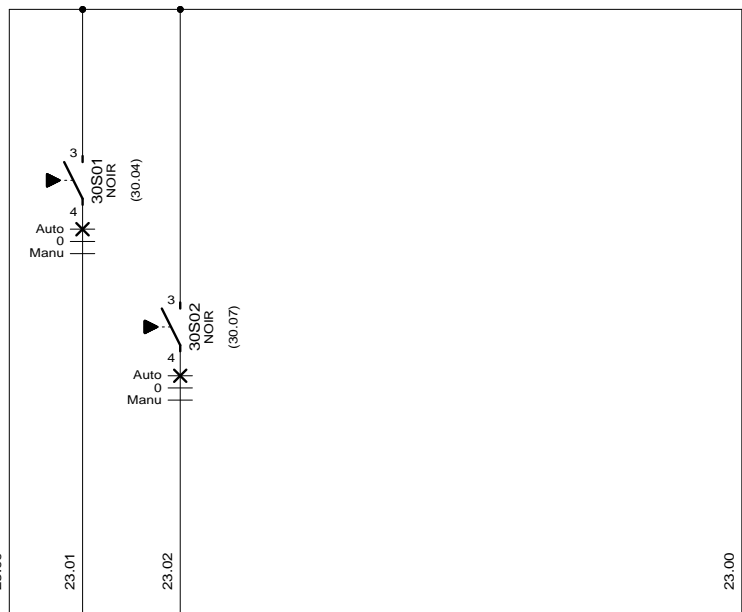

BORNIER	C	1	2	C	3	4	C	5	6	C	7	8
VOIES		1	2		3	4		5	6		7	8
DESIGNATION		(COMMUN VOIES 1 ET 2)	POSITION AUTO POMPE 1	POSITION AUTO POMPE 2	(COMMUN VOIES 3 ET 4)		(COMMUN VOIES 5 ET 6)			(COMMUN VOIES 7 ET 8)		
CARTE 8 ETOR SOFREL S550												

20E01-03
(20.10)



3, Rue Pierre Curie
91230 MONTGERON
Tél. : 01.69.52.47.00 - Fax : 01.69.52.47.01
e-mail : seguin@automatismes-seguin.fr
http://www.automatismes-seguin.fr

CARTE 8 ENTRES TOR EMPLACEMENT 3

CLIENT ET NOM DU DOSSIER / CUSTOMER AND NAME OF FOLDER		INDICE / REVIEW
SAUR Armoire PR Point P Montereau		0
DESSINATEUR DRAWER	M.H.	FOLIO/SHEET 23 / 24
N° AFFAIRE N° PROJECT	180137	
		VARD SERVICE PACK.11-(4.49.F)

CARTE 4 STOR-WDG SOFREL S550										
DESIGNATION	COMMANDE POMPE 1		COMMANDE POMPE 2						CHIEN DE GARDE	
	VOIES	1		2		3		4		5
BORNIER	1a	1b	2a	2b	3a	3b	4a	4b	Da	Db

20E01-04
(20.11)

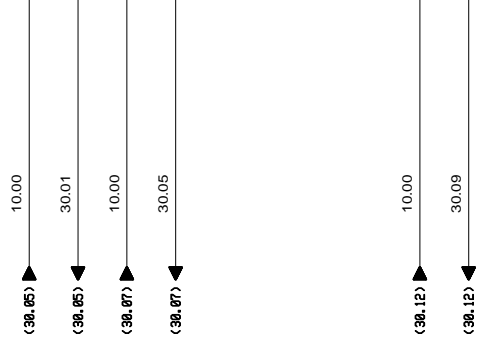

3, Rue Pierre Curie
91230 MONTGERON
Tél. : 01.69.52.47.00 - Fax : 01.69.52.47.01
e-mail : seguin@automatismes-seguin.fr
http://www.automatismes-seguin.fr

**CARTE 4 SORTIES TOR
EMPLACEMENT 4**

CLIENT ET NOM DU DOSSIER / CUSTOMER AND NAME OF FOLDER			INDICE / REVIEW
SAUR Armoire PR Point P Montereau			0
DESSINATEUR DRAWER	M.H.	FOLIO/SHEET	24 / 25
N° AFFAIRE N° PROJECT	180137	IGE XAO VARZ SERVICE PACK.11-(A.49.F)	

RACCORDEMENT :
POUR CAPTEUR AUTONOME

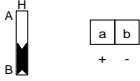

RACCORDEMENT :
POUR CAPTEUR TELEALIMENTE

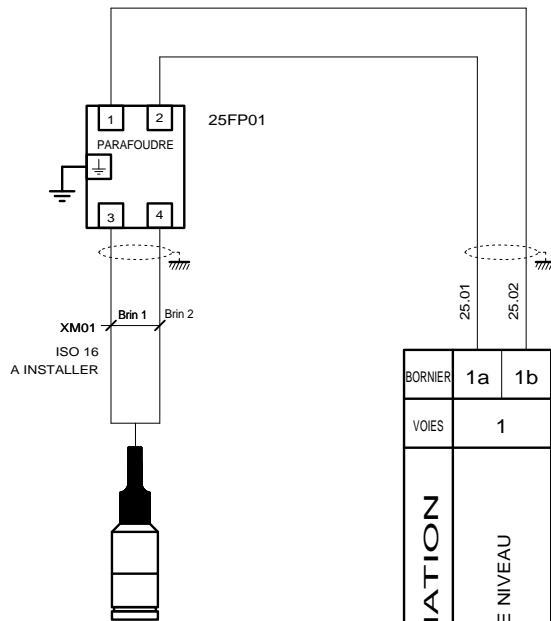
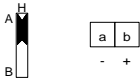

20E01-05
(20.13)

BORNIER	1a	1b	2a	2b
VOIES	1		2	
DESIGNATION	MESURE DE NIVEAU			
CARTE 2 EANA SOFREL S550				



3, Rue Pierre Curie
91230 MONTGERON
Tél. : 01.69.52.47.00 - Fax : 01.69.52.47.01
e-mail : seguin@automatismes-seguin.fr
<http://www.automatismes-seguin.fr>

CARTE 2 ENTREES ANALOGIQUES EMPLACEMENT 5

CLIENT ET NOM DU DOSSIER / CUSTOMER AND NAME OF FOLDER			INDICE / REVIEW
SAUR Armoire PR Point P Montereau			0
DESSINATEUR DRAWER	M.H.	FOLIO/SHEET	25 / 30
N° AFFAIRE N° PROJECT	180137	IGE XAO VAR2 SERVICE PACK.11-(4.49.F)	

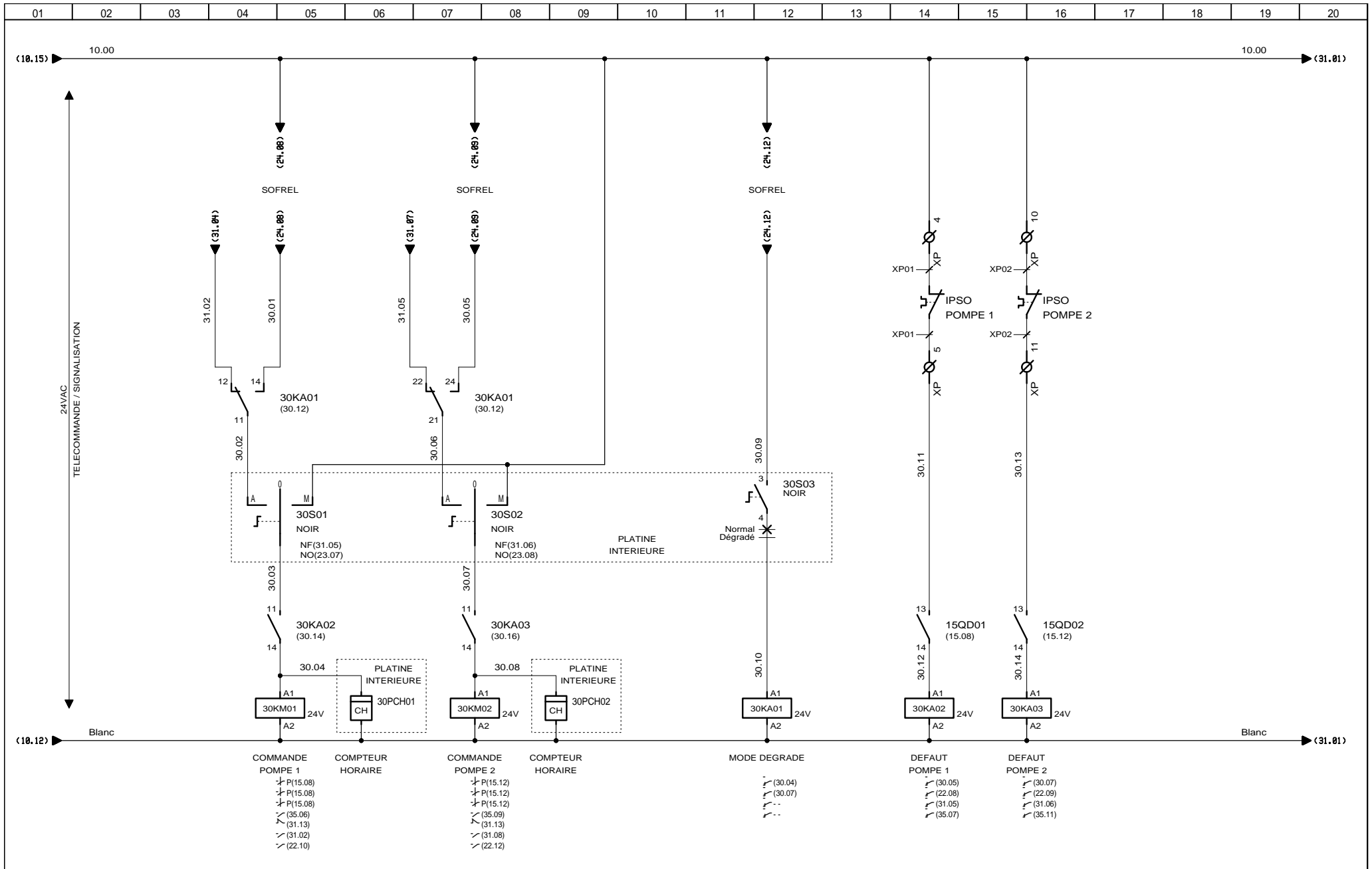

3, Rue Pierre Curie
91230 MONTGERON
Tél. : 01.69.52.47.00 - Fax : 01.69.52.47.01
e-mail : seguin@automatismes-seguin.fr
http://www.automatismes-seguin.fr

TELECOMMANDE POMPES

CLIENT ET NOM DU DOSSIER / CUSTOMER AND NAME OF FOLDER		INDICE / REVIEW
SAUR		O
Armoire PR Point P Montereau		
DESSINATEUR DRAWER	M.H.	
N° AFFAIRE N° PROJECT	180137	FOLIO/SHEET 30 / 31
VARZ SERVICE PACK.11-(4.49.F)		

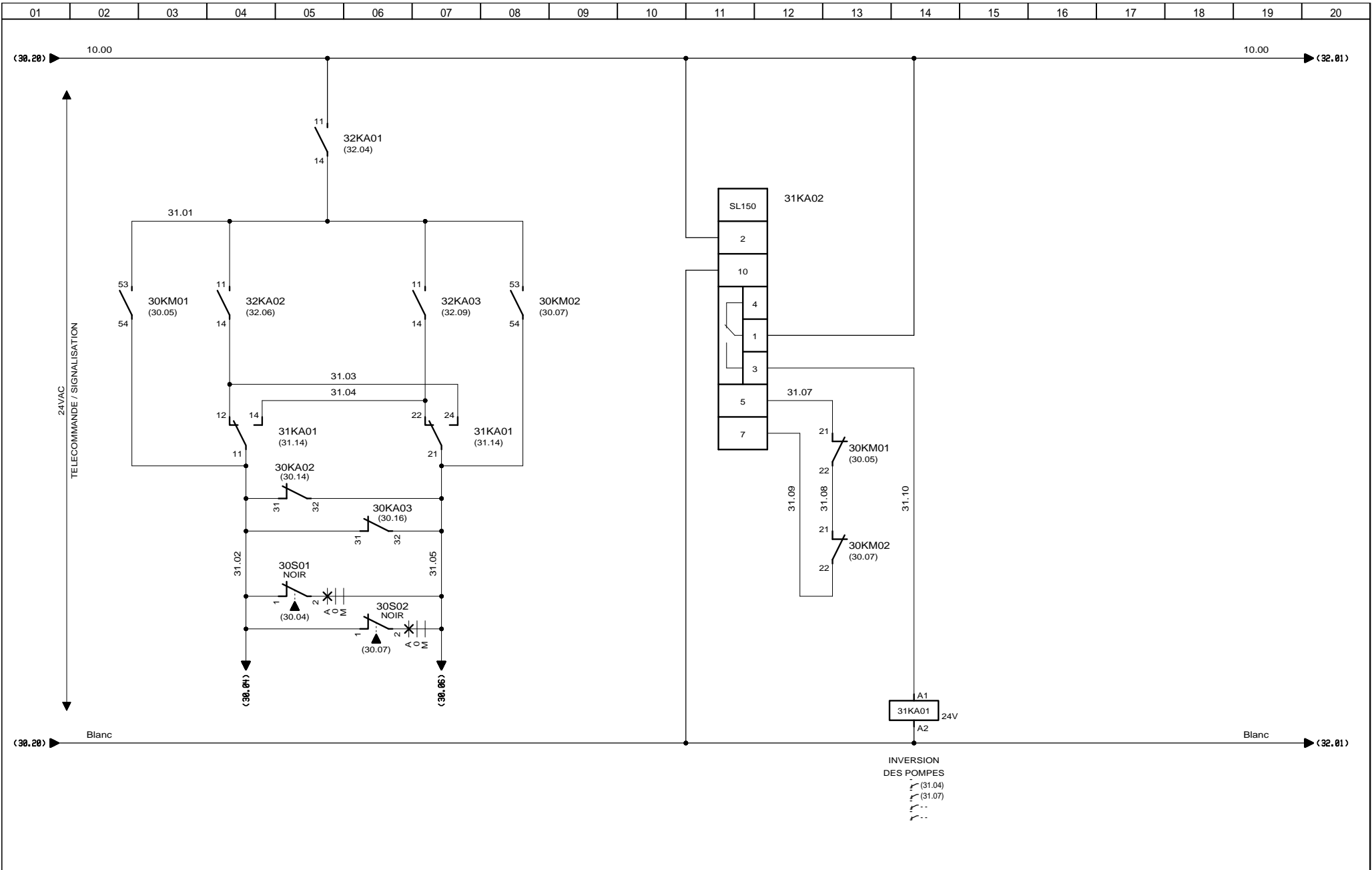



 3, Rue Pierre Curie
 91230 MONTGERON
 Tél. : 01.69.52.47.00 - Fax : 01.69.52.47.01
 e-mail : seguin@automatismes-seguin.fr
 http://www.automatismes-seguin.fr

TELECOMMANDE POMPES

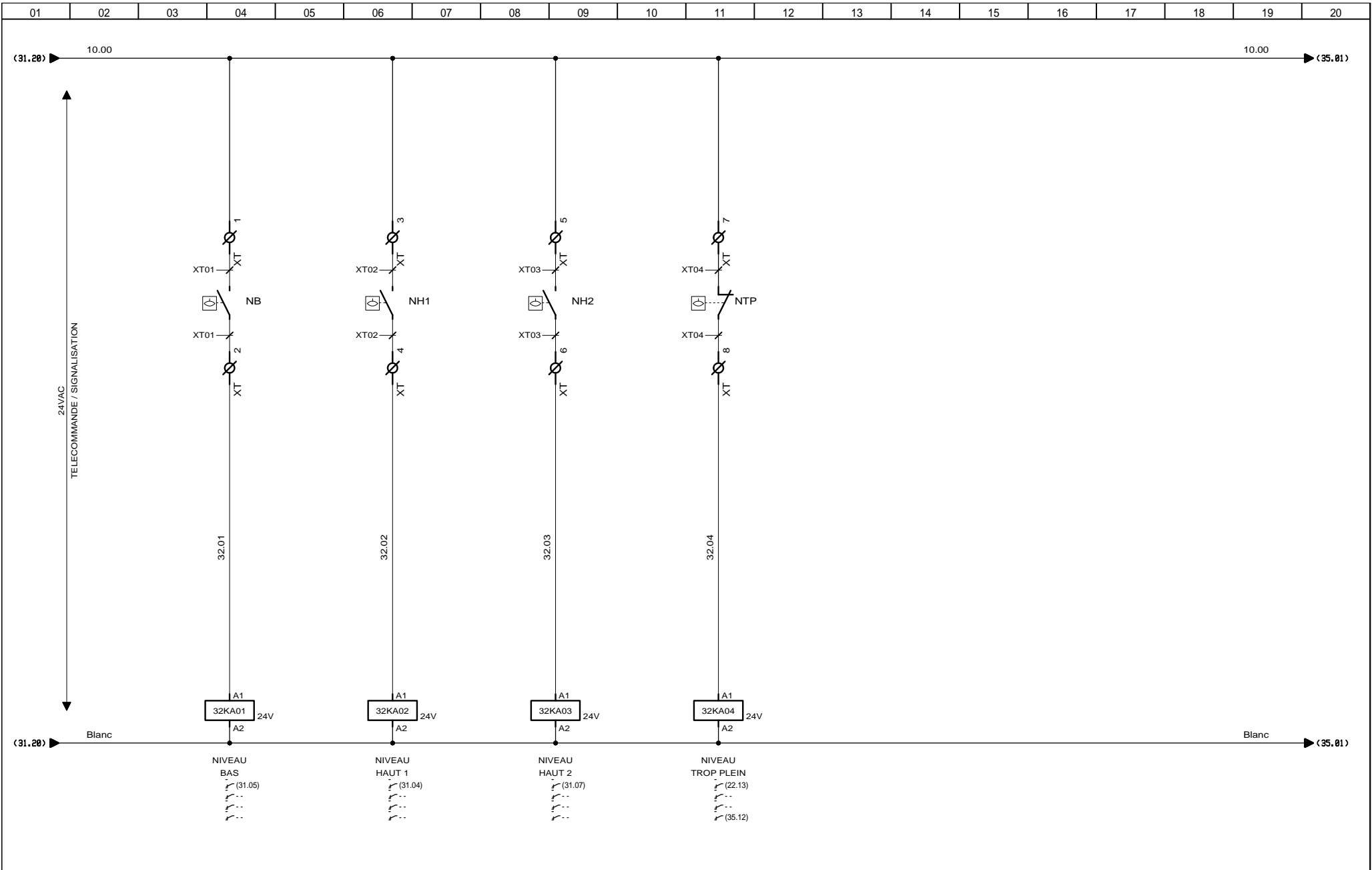
CLIENT ET NOM DU DOSSIER / CUSTOMER AND NAME OF FOLDER		INDICE / REVIEW
SAUR		O
Armoire PR Point P Montereau		
DESSINATEUR DRAWER	M.H.	FOLIO/SHEET 31/32
N° AFFAIRE N° PROJECT	180137	<small>VARZ SERVICE PACK 11-14-19-FR</small>



 3, Rue Pierre Curie
 91230 MONTGERON
 Tél. : 01.69.52.47.00 - Fax : 01.69.52.47.01
 e-mail : seguin@automatismes-seguin.fr
 http://www.automatismes-seguin.fr

TELECOMMANDE NIVEAUX

CLIENT ET NOM DU DOSSIER / CUSTOMER AND NAME OF FOLDER		INDICE / REVIEW
SAUR		O
Armoire PR Point P Montereau		 <small>VARZ SERVICE PACK.11-(4.49.F)</small>
DESSINATEUR / DRAWER	M.H.	
N° AFFAIRE / N° PROJECT	180137	
FOLIO/SHEET		32 / 35

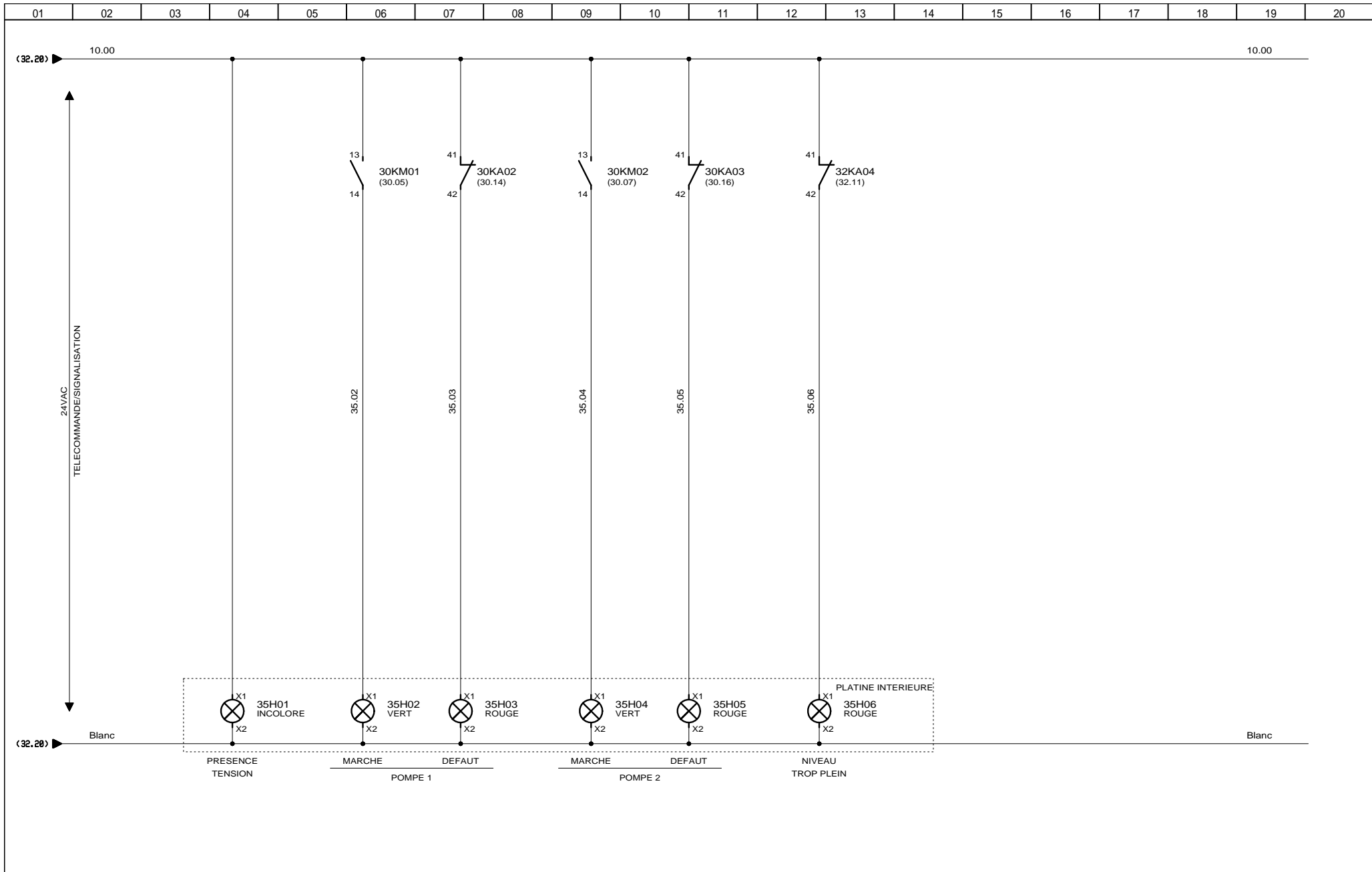

3, Rue Pierre Curie
91230 MONTGERON
Tél. : 01.69.52.47.00 - Fax : 01.69.52.47.01
e-mail : seguin@automatismes-seguin.fr
http://www.automatismes-seguin.fr

SIGNALISATION

CLIENT ET NOM DU DOSSIER / CUSTOMER AND NAME OF FOLDER		INDICE / REVIEW
SAUR		0
Armoire PR Point P Montereau		 <small>VARD SERVICE PACK 11 - (4.49.F)</small>
DESSINATEUR / DRAWER	M.H.	
N° AFFAIRE / N° PROJECT	180137	
FOLIO/SHEET		35 / 40

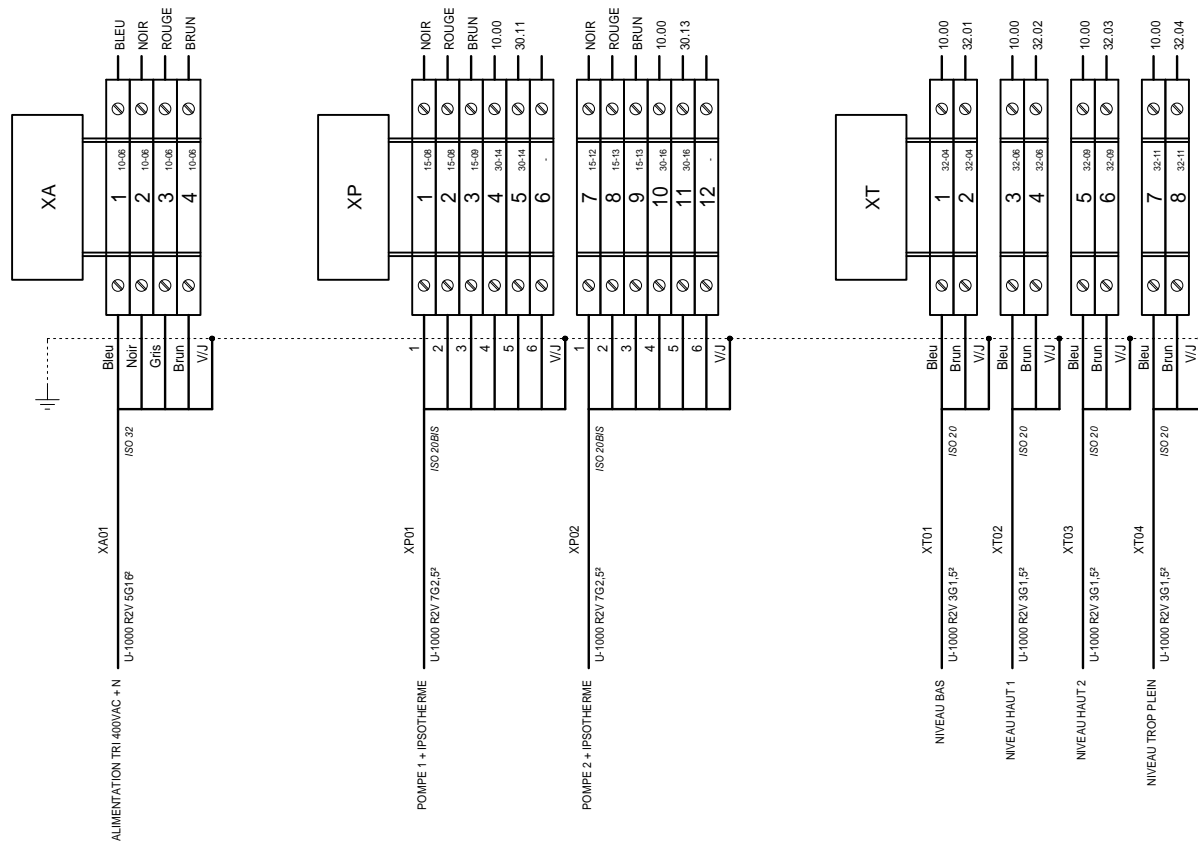

BORNIERS

CLIENT ET NOM DU DOSSIER / CUSTOMER AND NAME OF FOLDER		INDICE / REVIEW
SAUR		0
Armoire PR Point P Montereau		
DESSINATEUR / DRAWER	M.H.	FOLIO/SHEET 40 / 50
N° AFFAIRE / N° PROJECT	180137	
IGE XAO		VAR: SERVICE PACK.11-(A.49.F)

REPERE	DESIGNATION	REFERENCE	MARQUE	QTE
TOLERIE	COFFRET UNIVERSEL AVEC PORTE PLEINE SANS CHASSIS 1000x600x300, IP66, RAL7035	NSYS3D10630	SCHNEIDER ELECTRIC	1
	POIGNEE A CLE 1242E	NSYAEDL1242S3D	SCHNEIDER ELECTRIC	1
	PORTE INTERNE POUR COFFRET H1000xL600	NSYPIN106	SCHNEIDER ELECTRIC	1
	SOCLE FRONTAL SF/SM 100x600	NSYSPF6100	SCHNEIDER ELECTRIC	1
	JEU DE 2 TRAPPES LATERALES SOCLE SD 100X300	NSYSPS3100SD	SCHNEIDER ELECTRIC	1
	AUVENT POUR COFFRET L600xP300	NSYTJ6030	SCHNEIDER ELECTRIC	1
10E01	REPARTITEUR TETRAPOLAIRE TD 40 A, 12 CONNEXIONS	563740	ERICO	1
10E02	BARRETTE DE COUPURE BASSE, PLATINE PLASTIQUE 95x20mm, L = 125mm	034389	LEGRAND	1
10KA01	RELAIS INDUSTRIEL EMBROCHABLE, MONOSTABLE, 4INV, 24VAC + EMBASE + ETRIER	2903686 + 2900934 + 2900954	PHOENIX CONTACT	1
10PF01	RELAIS DE CONTROLE TRIPHASE POUR L'ORDRE ET LA PERTE DE PHASES, 208-480VAC, 1INV	DPA51CM44	CARLO GAVAZZI	1
10QD01	DISJONCTEUR IC60N 3P 1A, 440VAC/25kA, 133VDC/6kA, COURBE C	A9F74301	SCHNEIDER ELECTRIC	1
10QD02	DISJONCTEUR IC60N 2P 2A, 440VAC/25kA, 133VDC/6kA, COURBE C	A9F74202	SCHNEIDER ELECTRIC	1
10QD03	DISJONCTEUR DT40 1P+N 4A 6kA, COURBE C	A9N21022	SCHNEIDER ELECTRIC	1
10QIG01	INTERRUPTEUR DIFFERENTIEL IID TYPE AC 415VAC 4P 40A 300mA	A9R14440	SCHNEIDER ELECTRIC	1
10TR01	TRANSFORMATEUR DE COMMANDE ET DE SIGNALISATION MONOPHASEE 230-400V/24-48V, 100VA	044233	LEGRAND	1
12ECH01	RESISTANCE CHAUFFANTE PTC CS 060, 120-240V AC/DC, 50W	06000.0-00	STEGO	1
12ECL01	LAMPE LED 5W 220V 50-60Hz 500lm	NSYLAMT5LD1	SCHNEIDER ELECTRIC	1
12KTH01	PETIT THERMOSTAT KTO 011, 1NF, 0..60°C	01146.9-00	STEGO	1
12QD01	DISJONCTEUR DT40 VIGI 1P+N CLASSE AC 16A 30mA COURBE C	A9N21444	SCHNEIDER ELECTRIC	1
12QD02	DISJONCTEUR DT40 1P+N 1A 6kA, COURBE C	A9N21019	SCHNEIDER ELECTRIC	1
12QD03	DISJONCTEUR DT40 1P+N 1A 6kA, COURBE C	A9N21019	SCHNEIDER ELECTRIC	1
12S01	INTERRUPTEUR DE POSITION 1NO+1NF RB, M12 POUSSOIR A GALET, 1m CABLE	XCMD21F2L1	SCHNEIDER ELECTRIC	1
12X01	PRISE DE COURANT 2P+T 10/16A, 250VAC A ECLIPS	004280	LEGRAND	1
15PA01	AMPEREMETRE ROTEX R72A90-A, 0-10A-50A DIRECT DEV. 90D	192D1301	SOCOMEK	1
	2 CAPUCHONS	192Z1016	SOCOMEK	1
15PA02	AMPEREMETRE ROTEX R72A90-A, 0-10A-50A DIRECT DEV. 90D	192D1301	SOCOMEK	1
	2 CAPUCHONS	192Z1016	SOCOMEK	1
15QD01	DISJONCTEUR MOTEUR MAGNETO-THERMIQUE 4-6.3A, BORNES A VIS	GV2ME10	SCHNEIDER ELECTRIC	1
	ADDITIF FRONTAL F+O	GVAE11	SCHNEIDER ELECTRIC	1
15QD02	DISJONCTEUR MOTEUR MAGNETO-THERMIQUE 4-6.3A, BORNES A VIS	GV2ME10	SCHNEIDER ELECTRIC	1
	ADDITIF FRONTAL F+O	GVAE11	SCHNEIDER ELECTRIC	1
20E01	RACK S550 8 EMBLEMENTS AVEC ALIM SECTEUR 230VAC	T9950A100	SOFREL	1
20E01-01	MODULE DE COMMUNICATION GSM/GPRS-3 + ANTENNE BI-BANDE	V5900540	SOFREL	1
20E01-02	MODULE D'ENTREES, 8E TOR	V5900210	SOFREL	1
20E01-03	MODULE D'ENTREES, 8E TOR	V5900210	SOFREL	1
20E01-04	MODULE DE SORTIES, 4S TOR 1S TOR WDG 50V 1A	V5900310	SOFREL	1
20E01-05	MODULE D'ENTREES, 2E ANA MULTISTANDARD	V5900260	SOFREL	1
20FP01	PROTECTION SECTEUR 230V, 5kA, Up=1.2kV	T5300011	SOFREL	1
20G01	BATTERIE 12V, 7Ah	NP7-12	YUASA	1
20QD01	DISJONCTEUR DT40 1P+N 4A 6kA, COURBE C	A9N21022	SCHNEIDER ELECTRIC	1
22S01	TETE BOUTON TOURNANT 2 POSITIONS A SERRURE AVEC CLE N°455	ZB4BG2	SCHNEIDER ELECTRIC	1
	CORPS CONTACT NO	ZB4BZ101	SCHNEIDER ELECTRIC	1
25FP01	Dispositif de protection antisurtension - TT-2-PE-M-24DC -	2920641	PHOENIX CONTACT	1
	FLASQUE D'EXTREMITE TT-D-2-PE-M-BK	2920654	PHOENIX CONTACT	1
30KA01	RELAIS INDUSTRIEL EMBROCHABLE, MONOSTABLE, 4INV, 24VAC + EMBASE + ETRIER	2903686 + 2900934 + 2900954	PHOENIX CONTACT	1
30KA02	RELAIS INDUSTRIEL EMBROCHABLE, MONOSTABLE, 4INV, 24VAC + EMBASE + ETRIER	2903686 + 2900934 + 2900954	PHOENIX CONTACT	1
30KA03	RELAIS INDUSTRIEL EMBROCHABLE, MONOSTABLE, 4INV, 24VAC + EMBASE + ETRIER	2903686 + 2900934 + 2900954	PHOENIX CONTACT	1



3, Rue Pierre Curie
91230 MONTGERON
Tél. : 01.69.52.47.00 - Fax : 01.69.52.47.01
e-mail : seguin@automatismes-seguin.fr
http://www.automatismes-seguin.fr

NOMENCLATURE

CLIENT ET NOM DU DOSSIER / CUSTOMER AND NAME OF FOLDER		INDICE / REVIEW
SAUR		0
Armoire PR Point P Montereau		
DESSINATEUR DRAWER	M.H.	FOLIO/SHEET 50 / 51
N° AFFAIRE N° PROJECT	180137	
		IGE XAO VARZ SERVICE PACK 11-14-49-FI

REPERE	DESIGNATION	REFERENCE	MARQUE	QTE
30KM01	CONTACTEUR DE PUISSANCE 9A 1NO+1NF 24V 50/60Hz BLOC DE CONTACTS AUXILIAIRES 2NO FRONTAL	LC1D09B7 LADN20	SCHNEIDER ELECTRIC SCHNEIDER ELECTRIC	1 1
30KM02	CONTACTEUR DE PUISSANCE 9A 1NO+1NF 24V 50/60Hz BLOC DE CONTACTS AUXILIAIRES 2NO FRONTAL	LC1D09B7 LADN20	SCHNEIDER ELECTRIC SCHNEIDER ELECTRIC	1 1
30PCH01	COMPTEUR HORAIRE TOTALISATEUR 10...30V, 50Hz CADRE POUR COMPTEUR DIN H57	3220401071 BT008171	KUBLER KUBLER	1 1
30PCH02	COMPTEUR HORAIRE TOTALISATEUR 10...30V, 50Hz CADRE POUR COMPTEUR DIN H57	3220401071 BT008171	KUBLER KUBLER	1 1
30S01	TETE BOUTON TOURNANT 3 POSITIONS CORPS CONTACT O+F	ZB4BD3 ZB4BZ105	SCHNEIDER ELECTRIC SCHNEIDER ELECTRIC	1 1
30S02	TETE BOUTON TOURNANT 3 POSITIONS CORPS CONTACT O+F	ZB4BD3 ZB4BZ105	SCHNEIDER ELECTRIC SCHNEIDER ELECTRIC	1 1
30S03	TETE BOUTON TOURNANT 2 POSITIONS CORPS CONTACT NO	ZB4BD2 ZB4BZ101	SCHNEIDER ELECTRIC SCHNEIDER ELECTRIC	1 1
31KA01	RELAIS INDUSTRIEL EMBROCHABLE, MONOSTABLE, 4INV, 24VAC + EMBASE + ETRIER	2903686 + 2900934 + 2900954	PHOENIX CONTACT	1
31KA02	RELAIS PERMUTATION FLIP FLOP 24VAC + EMBASE DE RELAIS DETECTEUR DE NIVEAUX S 196 + ETRIER	SL150024 + 9399020101 + HF	CARLO GAVAZZI	1
32KA01	RELAIS INDUSTRIEL EMBROCHABLE, MONOSTABLE, 4INV, 24VAC + EMBASE + ETRIER	2903686 + 2900934 + 2900954	PHOENIX CONTACT	1
32KA02	RELAIS INDUSTRIEL EMBROCHABLE, MONOSTABLE, 4INV, 24VAC + EMBASE + ETRIER	2903686 + 2900934 + 2900954	PHOENIX CONTACT	1
32KA03	RELAIS INDUSTRIEL EMBROCHABLE, MONOSTABLE, 4INV, 24VAC + EMBASE + ETRIER	2903686 + 2900934 + 2900954	PHOENIX CONTACT	1
32KA04	RELAIS INDUSTRIEL EMBROCHABLE, MONOSTABLE, 4INV, 24VAC + EMBASE + ETRIER	2903686 + 2900934 + 2900954	PHOENIX CONTACT	1
35H01	VOYANT INCOLORE DEL 24V	XB7EV07BP	SCHNEIDER ELECTRIC	1
35H02	VOYANT VERT DEL 24V	XB7EV03BP	SCHNEIDER ELECTRIC	1
35H03	VOYANT ROUGE DEL 24V	XB7EV04BP	SCHNEIDER ELECTRIC	1
35H04	VOYANT VERT DEL 24V	XB7EV03BP	SCHNEIDER ELECTRIC	1
35H05	VOYANT ROUGE DEL 24V	XB7EV04BP	SCHNEIDER ELECTRIC	1
35H06	VOYANT ROUGE DEL 24V	XB7EV04BP	SCHNEIDER ELECTRIC	1



3, Rue Pierre Curie
91230 MONTGERON
Tél. : 01.69.52.47.00 - Fax : 01.69.52.47.01
e-mail : seguin@automatismes-seguin.fr
http://www.automatismes-seguin.fr

NOMENCLATURE

CLIENT ET NOM DU DOSSIER / CUSTOMER AND NAME OF FOLDER		INDICE / REVIEW
SAUR		0
Armoire PR Point P Montereau		
DESSINATEUR DRAWER	M.H.	FOLIO/SHEET 51 / 51
N° AFFAIRE N° PROJECT	180137	
		IGE XAO VARZ SERVICE PACK 11 - (A.49.F)