

LETTRE DE REPERAGE DES ELEMENTS DU SCHEMA

QI	INTERRUPTEUR	PCPI	CONTROLEUR D'ISOLEMENT	KT	RELAIS TEMPORISE	SA	COMMUTATEUR D'AMPEREMETRE
QIG	INTERRUPTEUR GENERAL	TR	TRANSFORMATEUR DE TENSION	KAU	RELAIS ARRÊT D'URGENCE	SV	COMMUTATEUR DE VOLTMETRE
QD	DISJONCTEUR	TC	TRANSFORMATEUR DE COURANT	UF	VARIATEUR	ECH	RESISTANCE CHAUFFANTE
QDG	DISJONCTEUR GENERAL	U	ONDULEUR, ALIMENTATION	UM	DEMARREUR	ECL	ECLAIRAGE
FP	PARAFODRE	KIC	INTER CREPUSCULAIRE	S	ORGANE DE COMMANDE	G	BATTERIE
FU	FUSIBLE	KIH	HORLOGE	H	VOYANT, SIRENE	P	INSTRUMENTATION
F	THERMIQUE	KTH	THERMOSTAT	PCH	COMPTEUR HORAIRE	X	PRISE DE COURANT, BORNIER
QF	SECTIONNEUR FUSIBLE	KM	CONTACTEUR	PA	AMPEREMETRE	E	MATERIELS AUTRES
PF	CONTROLEUR DE PHASE	KA	RELAIS	PV	VOLTMETRE	KTL	TELERUPTEUR

LETTER CODES FOR ITEMS DESIGNATION ON THE DRAWING

QI	SWITCH	PCPI	INSULATION CONTROLLER	KT	TEMPORIZES RELAY	SA	AMPEREMETER SWITCH
QIG	GENERAL SWITCH	TR	TENSION TRANSFORMER	KAU	EMERGENCY STOP RELAY	SV	VOLTMETER SWITCH
QD	BREAKER	TC	CURRENT TRANSFORMER	UF	VELOCITY VARIATOR	ECL	LIGHT
QDG	GENERAL BREAKER	U	INVERTER, SUPPLY	UM	MOTOR STARTER	ECH	HEATER
FP	LIGHTNING PROTECTOR	KIC	DIMMER	S	CONTROL UNIT	G	BATTERY
FU	FUSE	KIH	CLOCK	H	INDICATOR	P	INSTRUMENTATION
F	THERMAL RELAY	KTH	THERMOSTAT	PCH	TIMER	X	SOCKET, TERMINAL BLOCK
QF	DISCONNECTING SWITCH	KM	CONTACTOR	PA	AMPEREMETER	E	OTHER EQUIPMENTS
PF	PHASE CONTROLLER	KA	RELAY	PV	VOLTMETER	KTL	TELEBREAKER

COULEURS DE FILS

TRI 400V: <= 6 mm2 Noir Rouge Brun
> 6 mm2 Noir Bagué Noir Rouge Brun

NEUTRE: Bleu Clair

230VAC: Rouge avec Commun Bobines Blanc (*)

230VAC ONDULE: Neutre Bleu Clair Bagué Orange
Phase Noir Bagué Orange

110VAC: Noir avec Commun Bobines Blanc (*)

24VAC: Violet avec Commun Bobines Blanc (*)

24VDC: Bleu Foncé avec Commun Bobines Blanc (*)

48VAC: Violet avec Commun Bobines Blanc (*)

48VDC: Bleu Foncé avec Commun Bobines Blanc (*)

REPORTS: Orange

TERRE: Vert/Jaune

ANALOGIQUE: Une Paire + Brun - Blanc
Unifilaire Blanc

TENSION EXTERNE PERMANENTE INTER GENERAL OUVERT: Orange

ATTENTION

Si plusieurs tensions de télécommande, alors prendre uniquement le 230VAC avec Commun Bobines Blanc

(*) Si Télécommande

WIRE COLOR

TRI 400V: <= 6 mm2 Black Red Brown
> 6 mm2 Black with Ring Black Red Brown

NEUTRE: Light Blue

230VAC: Red with Spods Common White (*)

230VAC UPS: Neutre Light Blue with Ring Orange
Phase Black with Ring Orange

110VAC: Black with Spods Common White (*)

24VAC: Purple with Spods Common White (*)

24VDC: Dark Bleu with Spods Common White (*)

48VAC: Purple with Spods Common White (*)

48VDC: Dark Bleu with Spods Common White (*)

REPORTS: Orange

GROUND: Green/Yellow

ANALOGICAL: One Pair + Brown - White
Unifilar White

PERMANENTLY EXTERNAL POWER GENERAL BREAKER OPEN: Orange

CAUTION

If There are Several Tensions of Command Then to take Only the 230VAC with Spods Common White

(*) If Command

TYPE DE RELAIS ET DE CONTACT DANS LE SCHEMA

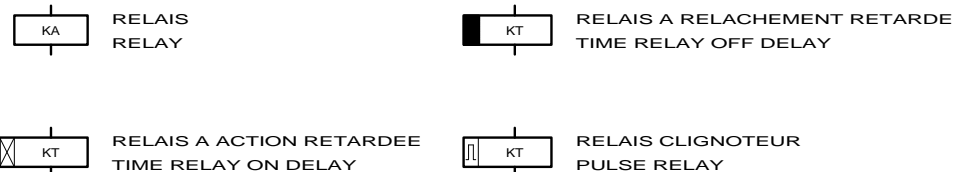

RELAY AND CONTACT TYPE IN THE DRAWING



LE SCHEMA EST REPRESENTÉ HORS TENSION ET GENERATEUR HORS SERVICE

THE DRAWING IS SHOWN OUT OF VOLTAGE AND WITH GENERATOR OUT OF SERVICE



3, Rue Pierre Curie
91230 MONTGERON
Tél. : 01.69.52.47.00 - Fax : 01.69.52.47.01
e-mail : seguin@automatismes-seguin.fr
http://www.automatismes-seguin.fr

LEGENDE DU SCHEMA ELECTRIQUE

CLIENT ET NOM DU DOSSIER / CUSTOMER AND NAME OF FOLDER		INDICE / REVIEW
SAUR		0
PR Darvault STEF		
DESSINATEUR / DRAWER	F.CO.	IGE-XAO
N° AFFAIRE / N° PROJECT	160327	FOLIO/SHEET 03/04
		VARI SERVICE PACK 7A

CODE DU REPERAGE

LETTER CODE

1/ DES APPAREILS DANS LES ARMOIRES
APPARATUS IN THE CABINETS



52 KA 01

N° D'ORDRE DANS LE FOLIO D'ORIGINE
ORDER NUMBER ON ORIGINAL SHEET

LETTRE DE REPERAGE
LETTER CODES FOR ITEM

N° DU FOLIO D'ORIGINE
ORIGINAL SHEET NUMBER

2/ DES FILS DE CABLAGE
WIRING

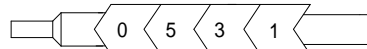

N° DU FOLIO D'ORIGINE
ORIGINAL SHEET NUMBER

N° DU FIL DANS LE FOLIO D'ORIGINE
NUMBER OF THE WIRE ON ORIGINAL SHEET

3/ REPORT DES CONTACTS DANS LE SCHEMA
CONTACT REPORT IN THE DRAWING



17.29

N° DE LA COLONNE OU EST UTILISE LE CONTACT
COLUMN NUMBER WHERE THE CONTACT IS USED

N° DU FOLIO OU EST UTILISE LE CONTACT
SHEET NUMBER WHERE THE CONTACT IS USED

4/ REPRESENTATION DES BORNES ET BORNIERES DANS LE SCHEMA
BINDINGS SCREWS VIEW IN THE DRAWING



N° D'ORDRE (SI NECESSAIRE)
ORDER NUMBER (IF NECESSARY)

NATURE DU BORNIER
NATURE OF TERMINAL BLOCK

A : ALIMENTATION
P : PUISSANCE
T : TELECOMMANDE
M : MESURE
R : REPORTS



LE SCHEMA EST REPRESENTE HORS TENSION ET GENERATEUR HORS SERVICE

THE DRAWING IS SHOWN OUT OF VOLTAGE AND WITH GENERATOR OUT OF SERVICE



3, Rue Pierre Curie
91230 MONTGERON
Tél. : 01.69.52.47.00 - Fax : 01.69.52.47.01
e-mail : seguin@automatismes-seguin.fr
http://www.automatismes-seguin.fr

LEGENDE DU SCHEMA ELECTRIQUE

CLIENT ET NOM DU DOSSIER / CUSTOMER AND NAME OF FOLDER		INDICE / REVIEW
SAUR		0
PR Darvault STEF		IGE-XAO
DESSINATEUR DRAWER	F.CO.	FOLIO/SHEET 04/05
N° AFFAIRE N° PROJECT	160327	VARI SERVICE PACK 7A

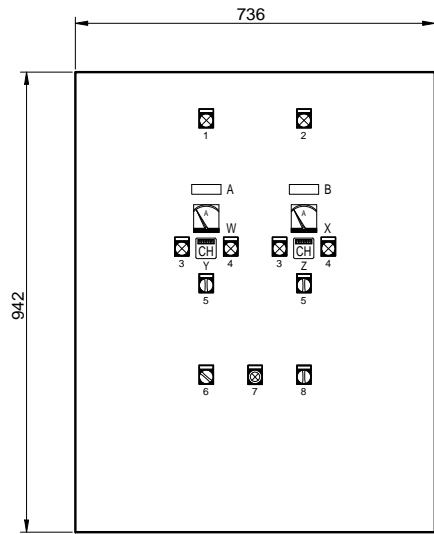

PORTE INTERNE
(dimensions utiles : 800x640mm)

ETIQUETTES 60x20

- A - POMPE 1
- B - POMPE 2

ETIQUETTES TELEMECANIQUE

- 1 - PRESENCE TENSION
- 2 - MODE DEGRADE
- 3 - MARCHE
- 4 - DEFAUT
- 5 - AUTO / 0 / MAIN
- 6 - NORMAL / SECOURS
- 7 - REARMEMENT DEFAULTS
- 8 - INTERVENTION / NORMAL / TEST COM

DIVERS

- W - 15PA01
- X - 16PA01
- Y - 30PCH01
- Z - 30PCH02



3, Rue Pierre Curie
91230 MONTGERON
Tél. : 01.69.52.47.00 - Fax : 01.69.52.47.01
e-mail : seguin@automatismes-seguin.fr
http://www.automatismes-seguin.fr

IMPLANTATION PORTE INTERNE

CLIENT ET NOM DU DOSSIER / CUSTOMER AND NAME OF FOLDER		INDICE / REVIEW
SAUR PR Darvault STEF		0
DESSINATEUR DRAWER	F.CO.	FOLIO/SHEET 05 / 10
N° AFFAIRE N° PROJECT	160327	
		IGE-XAO VARI SERVICE PACK 7A

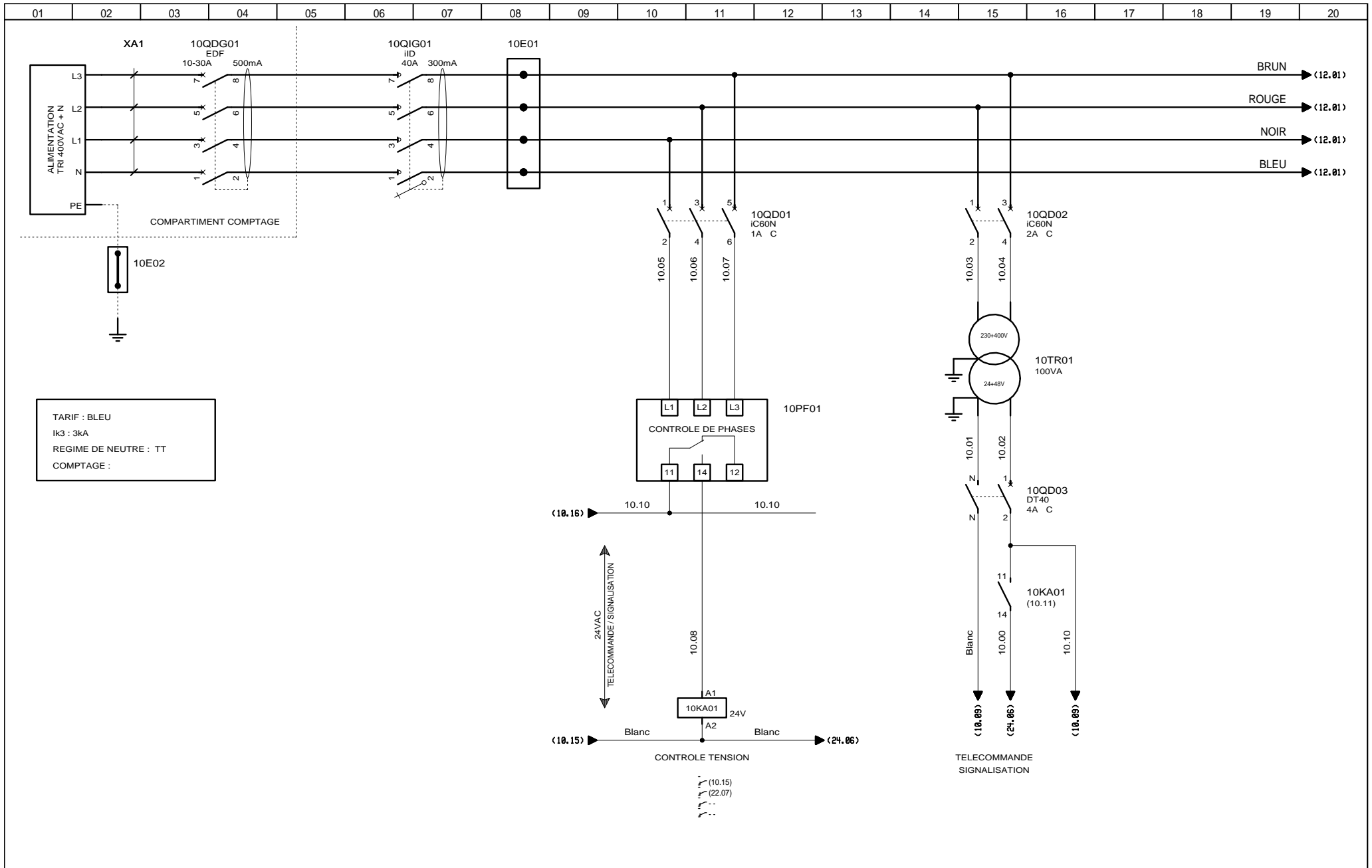

3, Rue Pierre Curie
91230 MONTGERON
Tél. : 01.69.52.47.00 - Fax : 01.69.52.47.01
e-mail : seguin@automatismes-seguin.fr
http://www.automatismes-seguin.fr

DISTRIBUTION 400VAC

CLIENT ET NOM DU DOSSIER / CUSTOMER AND NAME OF FOLDER		INDICE / REVIEW
SAUR PR Darvault STEF		O
DESSINATEUR DRAWER	F.CO.	
N° AFFAIRE N° PROJECT	160327	
FOLIO/SHEET 10 / 12		VARI SERVICE PACK 7A

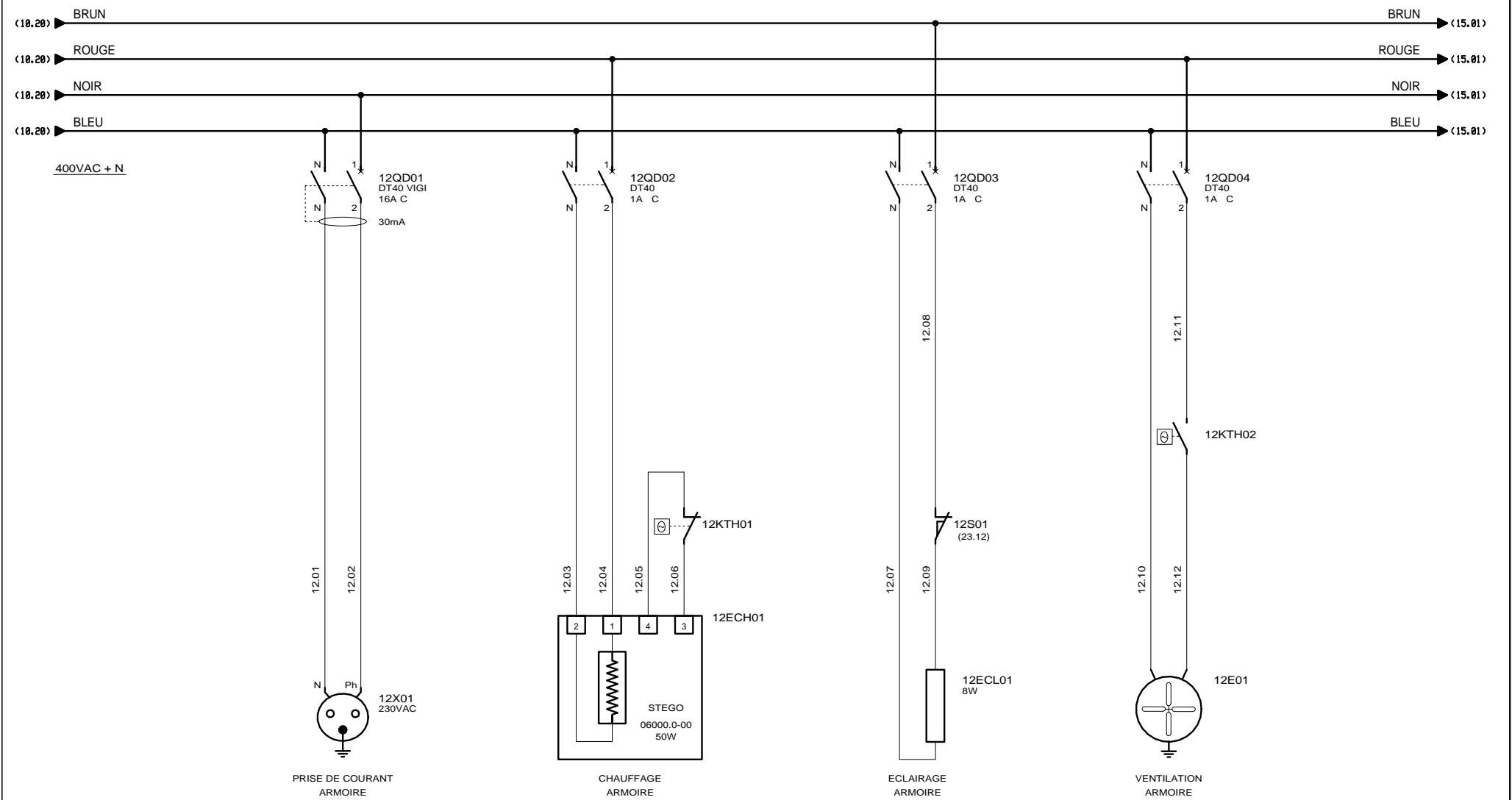



AUTOMATISMES SEGUIN
Systeme Qualité

3, Rue Pierre Curie
91230 MONTGERON
Tél. : 01.69.52.47.00 - Fax : 01.69.52.47.01
e-mail : seguin@automatismes-seguin.fr
http://www.automatismes-seguin.fr

**DISTRIBUTION 400VAC
UTILITES**

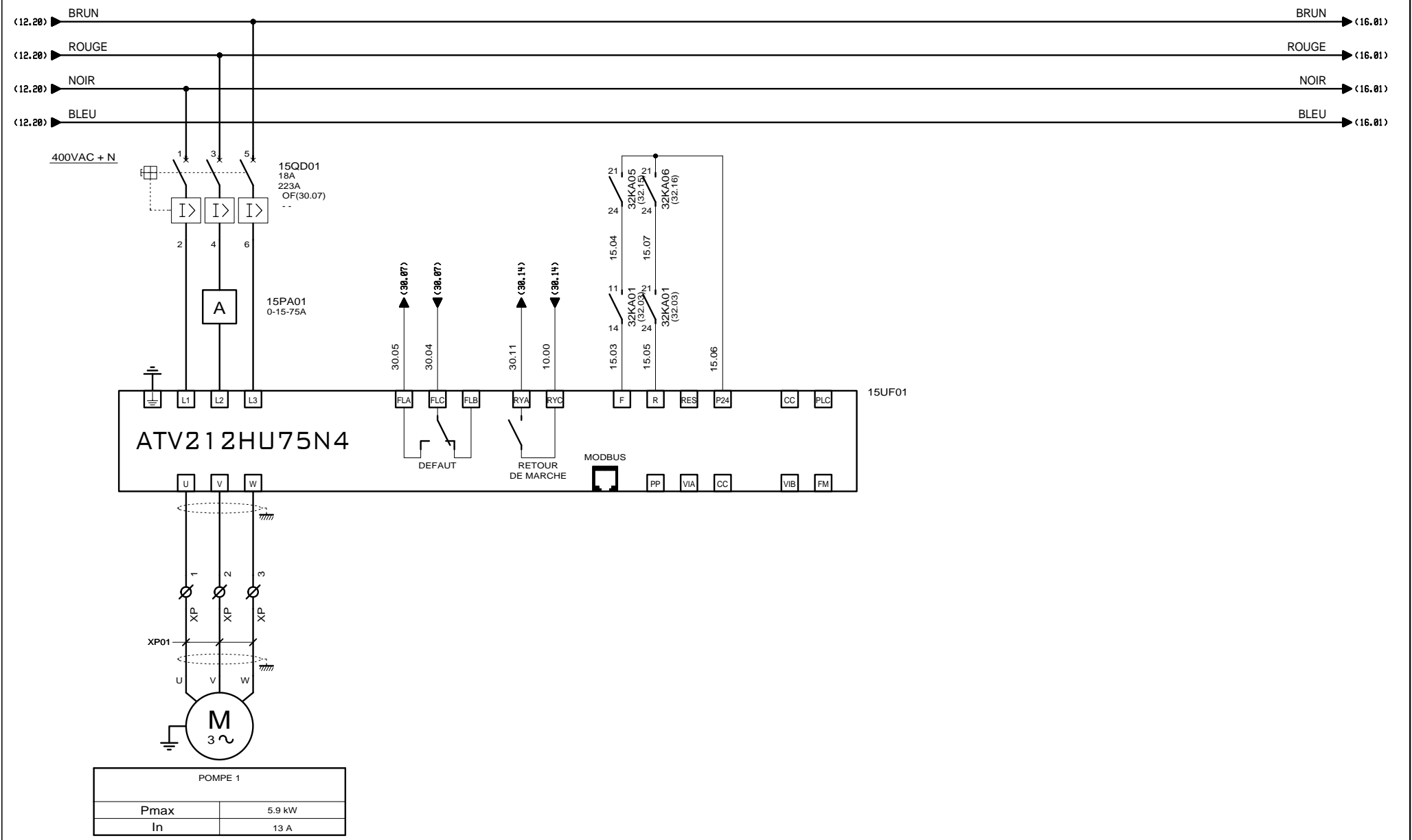
CLIENT ET NOM DU DOSSIER / CUSTOMER AND NAME OF FOLDER		INDICE / REVIEW
SAUR PR Darvault STEF		0
DESSINATEUR DRAWER	F.CO.	IGE-XAO
N° AFFAIRE N° PROJECT	160327	
FOLIO/SHEET 12 / 15		V4R1 SERVICE PACK 7A





 3, Rue Pierre Curie
 91230 MONTGERON
 Tél. : 01.69.52.47.00 - Fax : 01.69.52.47.01
 e-mail : seguin@automatismes-seguin.fr
 http://www.automatismes-seguin.fr

PUISSANCE POMPE 1

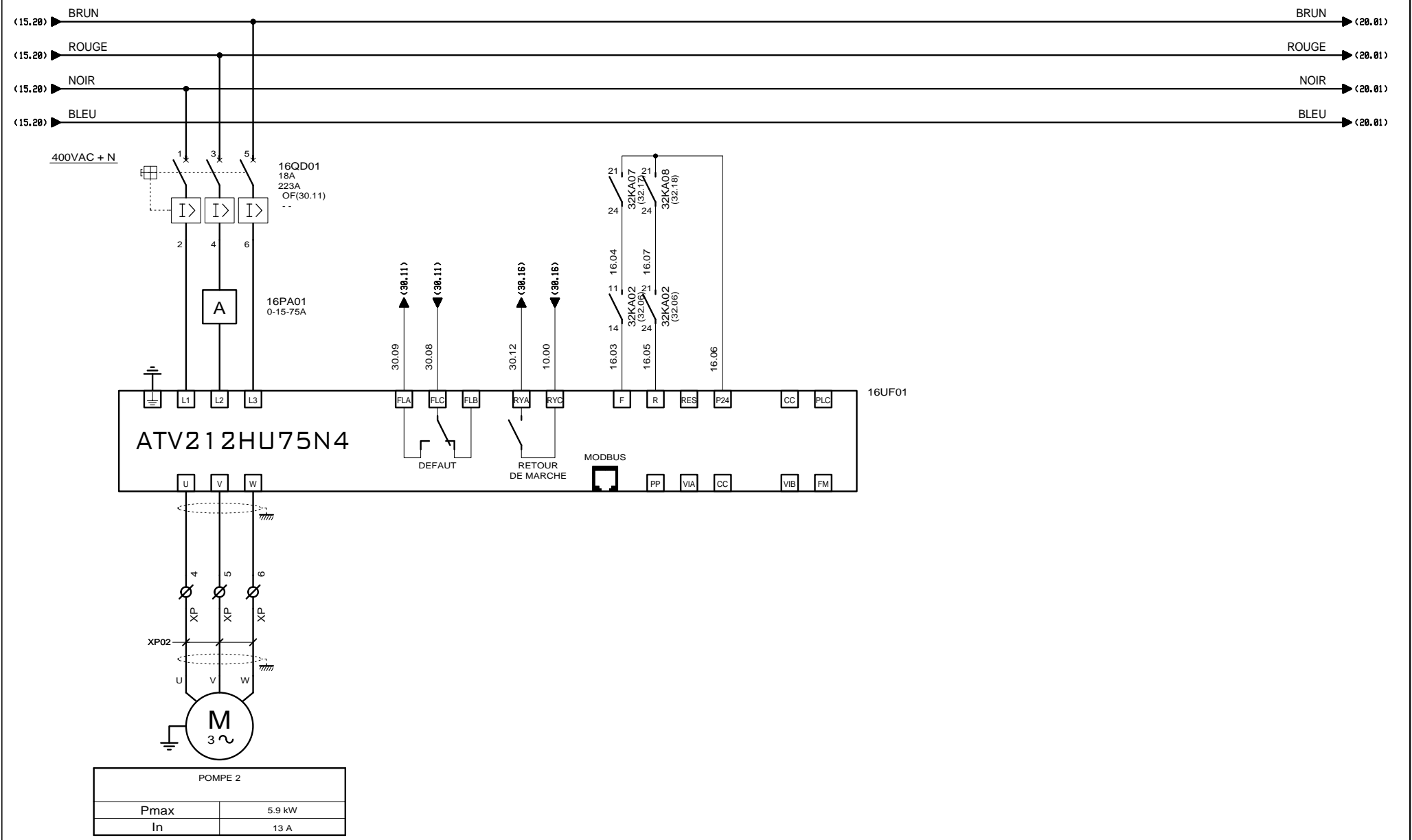
CLIENT ET NOM DU DOSSIER / CUSTOMER AND NAME OF FOLDER		INDICE / REVIEW
SAUR PR Darvault STEF		O
DESSINATEUR DRAWER	F.CO.	 VARI SERVICE PACK 7A
N° AFFAIRE N° PROJECT	160327	
FOLIO/SHEET		15 / 16





 3, Rue Pierre Curie
 91230 MONTGERON
 Tél. : 01.69.52.47.00 - Fax : 01.69.52.47.01
 e-mail : seguin@automatismes-seguin.fr
 http://www.automatismes-seguin.fr

PUISSANCE POMPE 2

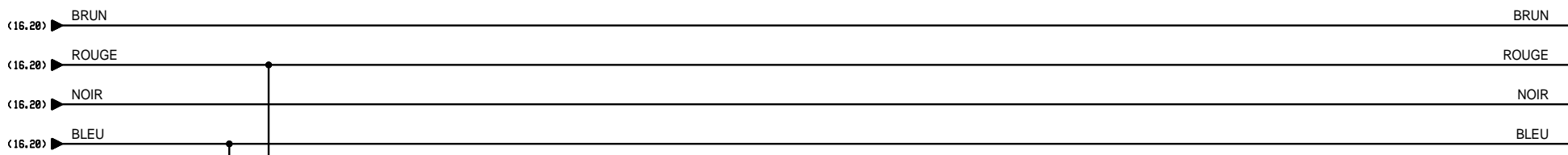
CLIENT ET NOM DU DOSSIER / CUSTOMER AND NAME OF FOLDER		INDICE / REVIEW
SAUR		O
PR Darvault STEF		
DESSINATEUR DRAWER	F.CO.	FOLIO/SHEET 16 / 20
N° AFFAIRE N° PROJECT	160327	VARI SERVICE PACK 7A

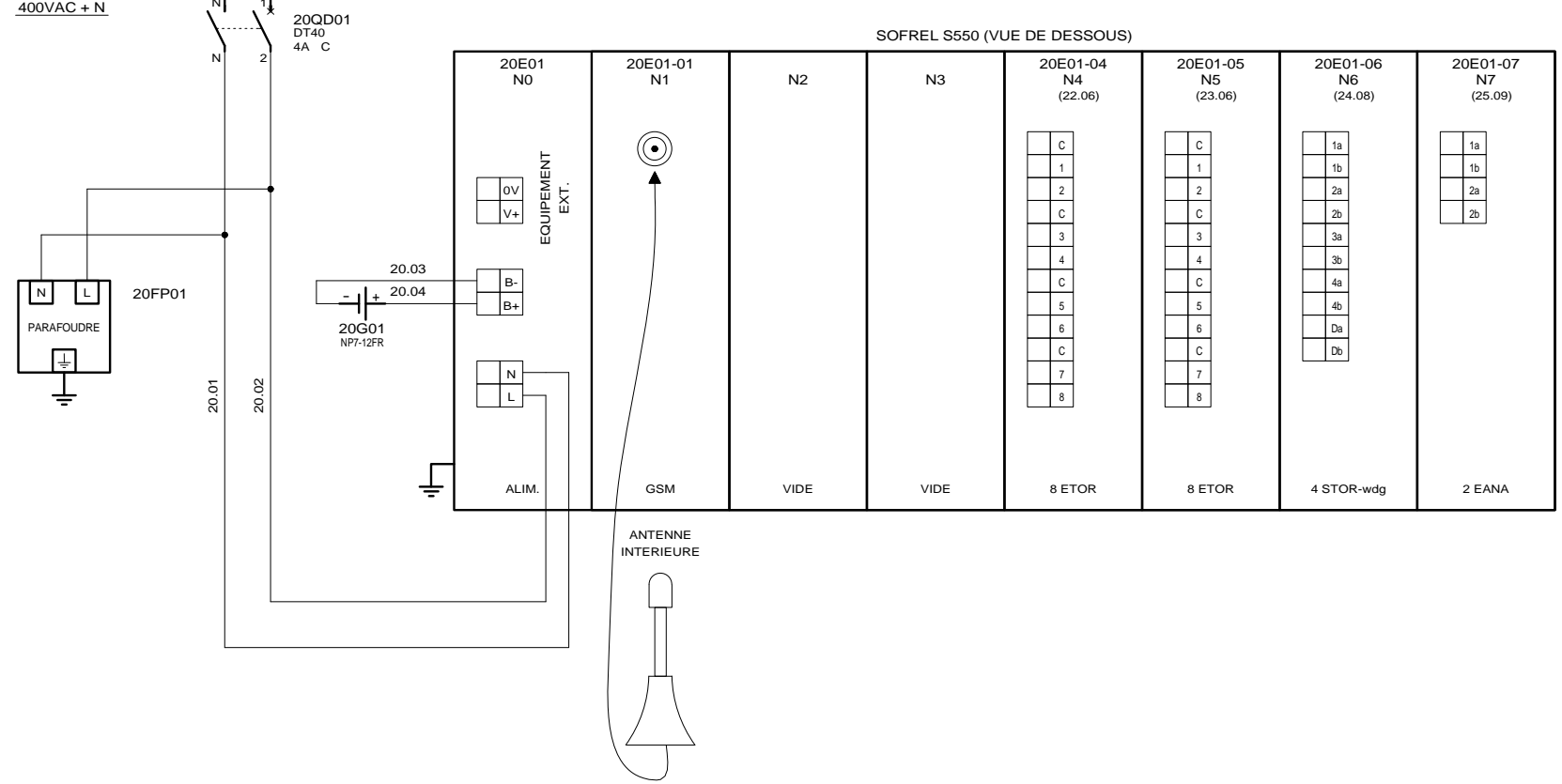

SOFREL S550 (VUE DE DESSOUS)



ALIMENTATION SOFREL S550

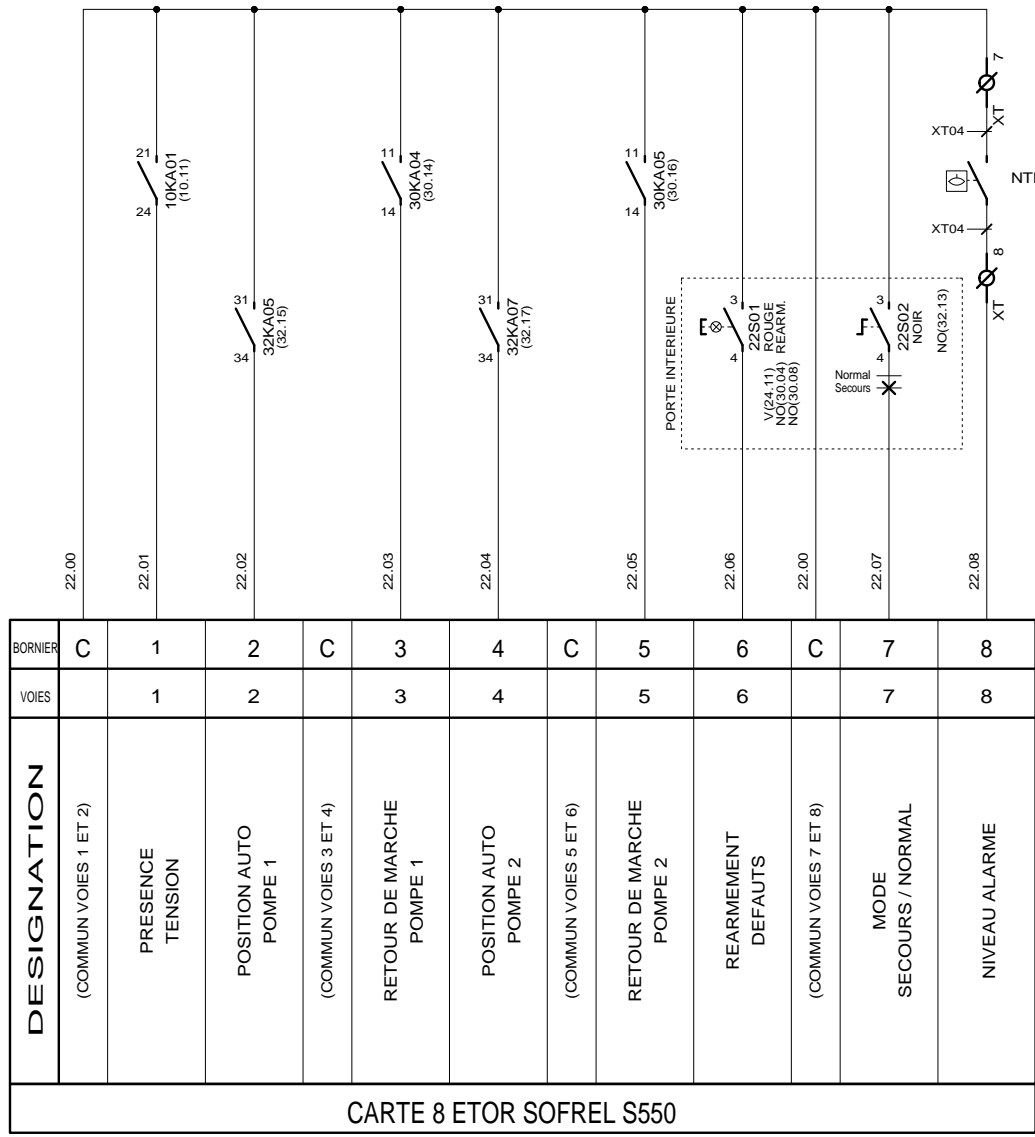

20E01-04
(20.11)

BORNIER	C	1	2	C	3	4	C	5	6	C	7	8
VOIES		1	2		3	4		5	6		7	8
DESIGNATION		PRESENCE TENSION (COMMUN VOIES 1 ET 2)	POSITION AUTO POMPE 1 (COMMUN VOIES 3 ET 4)		RETOUR DE MARCHÉ POMPE 1	POSITION AUTO POMPE 2 (COMMUN VOIES 5 ET 6)		RETOUR DE MARCHÉ POMPE 2	REARMEMENT DEFAULTS (COMMUN VOIES 7 ET 8)		MODE SECOURS / NORMAL	NIVEAU ALARME
CARTE 8 ETOR SOFREL S550												

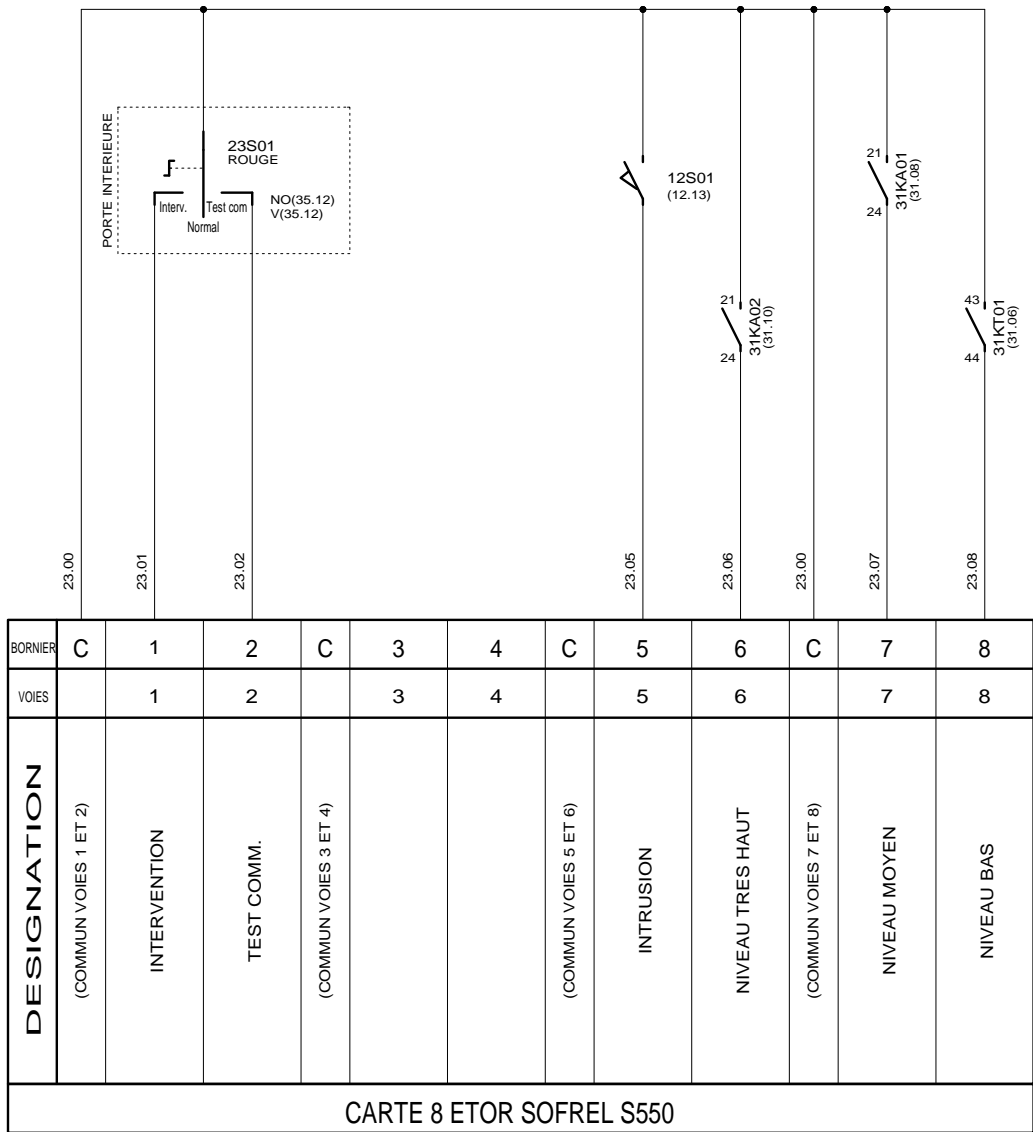

20E01-05
(20.13)



3, Rue Pierre Curie
91230 MONTGERON
Tél. : 01.69.52.47.00 - Fax : 01.69.52.47.01
e-mail : seguin@automatismes-seguin.fr
http://www.automatismes-seguin.fr

**CARTE 8 ENTRES TOR
EMPLACEMENT 5**

CLIENT ET NOM DU DOSSIER / CUSTOMER AND NAME OF FOLDER		INDICE / REVIEW
SAUR PR Darvault STEF		0
DESSINATEUR DRAWER	F.CO.	FOLIO/SHEET 23 / 24
N° AFFAIRE N° PROJECT	160327	
		VARI SERVICE PACK 7A

CARTE 4 STOR-wdg SOFREL S550										
DESIGNATION	COMMANDE POMPE 1		COMMANDE POMPE 2		REARMEMENT DEFAULTS		CHIEN DE GARDE			
VOIES	1		2		3		4		5	
BORNIER	1a	1b	2a	2b	3a	3b	4a	4b	Da	Db

20E01-06
(20.14)

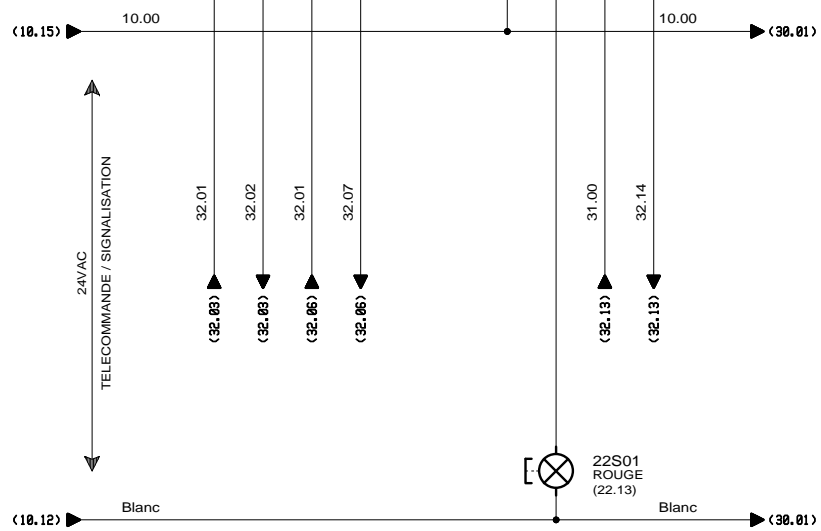

RACCORDEMENT :
POUR CAPTEUR AUTONOME

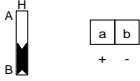

RACCORDEMENT :
POUR CAPTEUR TELEALIMENTE

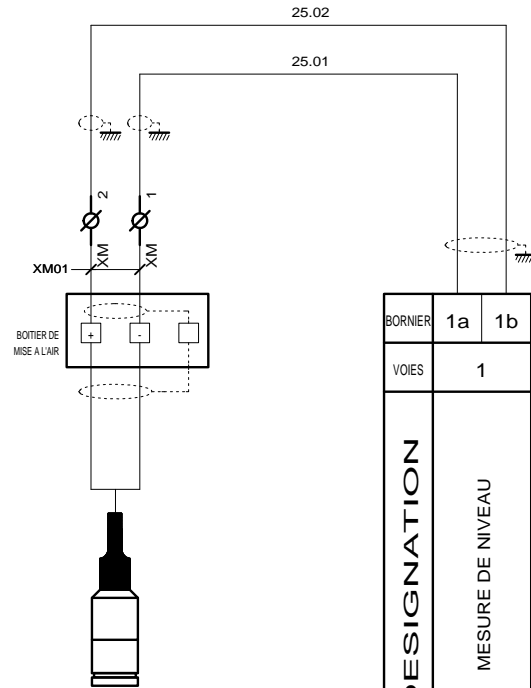
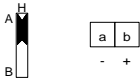

BORNIER	1a	1b	2a	2b
VOIES	1		2	
DESIGNATION	MESURE DE NIVEAU			
CARTE 2 EANA SOFREL S550				

20E01-07
(20.16)



3, Rue Pierre Curie
91230 MONTGERON
Tél. : 01.69.52.47.00 - Fax : 01.69.52.47.01
e-mail : seguin@automatismes-seguin.fr
<http://www.automatismes-seguin.fr>

CARTE 2 ENTrees ANALOGIQUES EMPLACEMENT 7

CLIENT ET NOM DU DOSSIER / CUSTOMER AND NAME OF FOLDER			INDICE / REVIEW
SAUR PR Darvault STEF			0
DESSINATEUR DRAWER	F.CO.	FOLIO/SHEET	25 / 30
N° AFFAIRE N° PROJECT	160327	 <small>VARI SERVICE PACK 7A</small>	

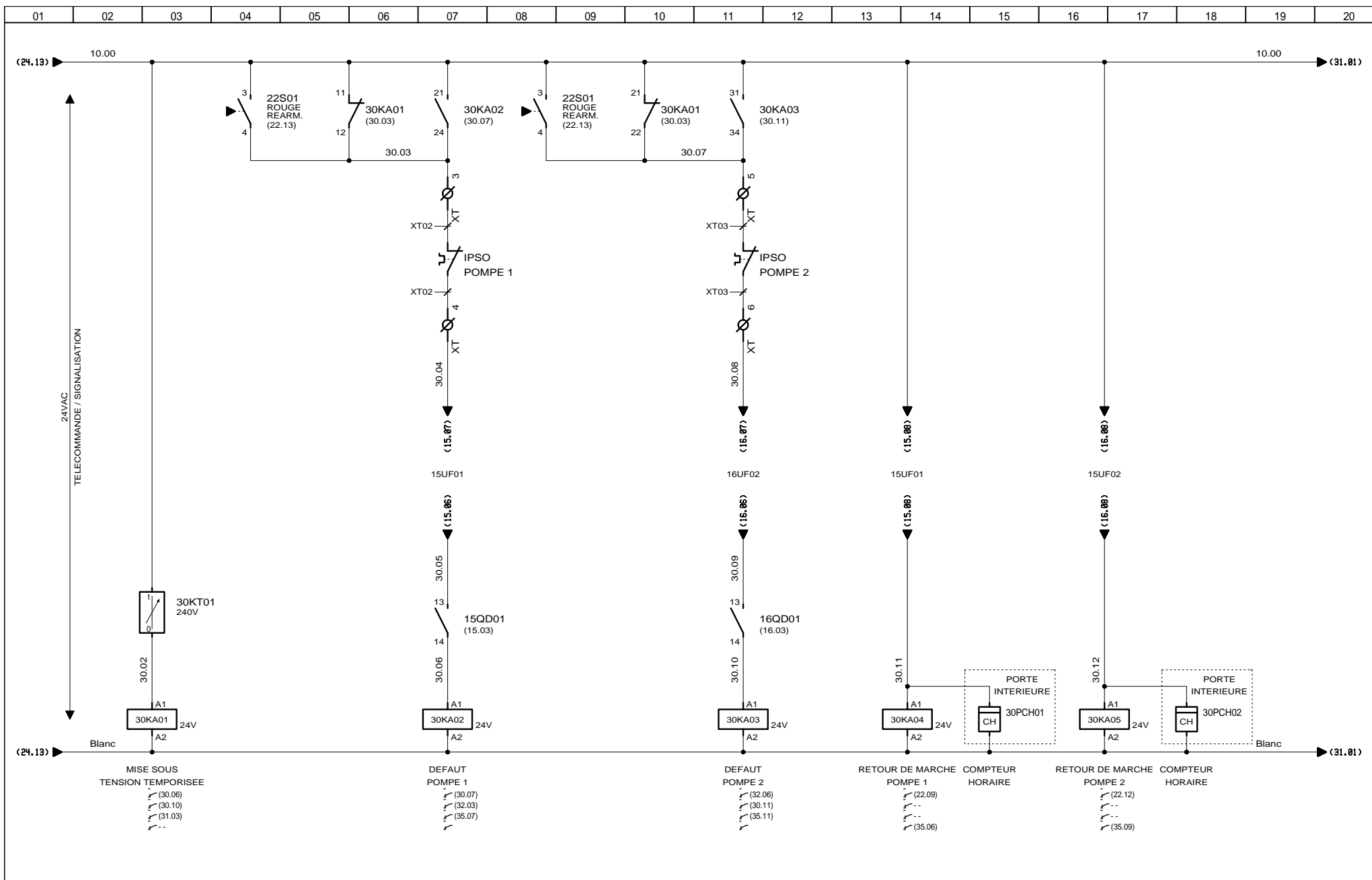

3, Rue Pierre Curie
91230 MONTGERON
Tél. : 01.69.52.47.00 - Fax : 01.69.52.47.01
e-mail : seguin@automatismes-seguin.fr
http://www.automatismes-seguin.fr

TELECOMMANDE

CLIENT ET NOM DU DOSSIER / CUSTOMER AND NAME OF FOLDER		INDICE / REVIEW
SAUR		O
PR Darvault STEF		IGE-XAO
DESSINATEUR DRAWER	F.CO.	FOLIO/SHEET 30/31
N° AFFAIRE N° PROJECT	160327	VARI SERVICE PACK 7A

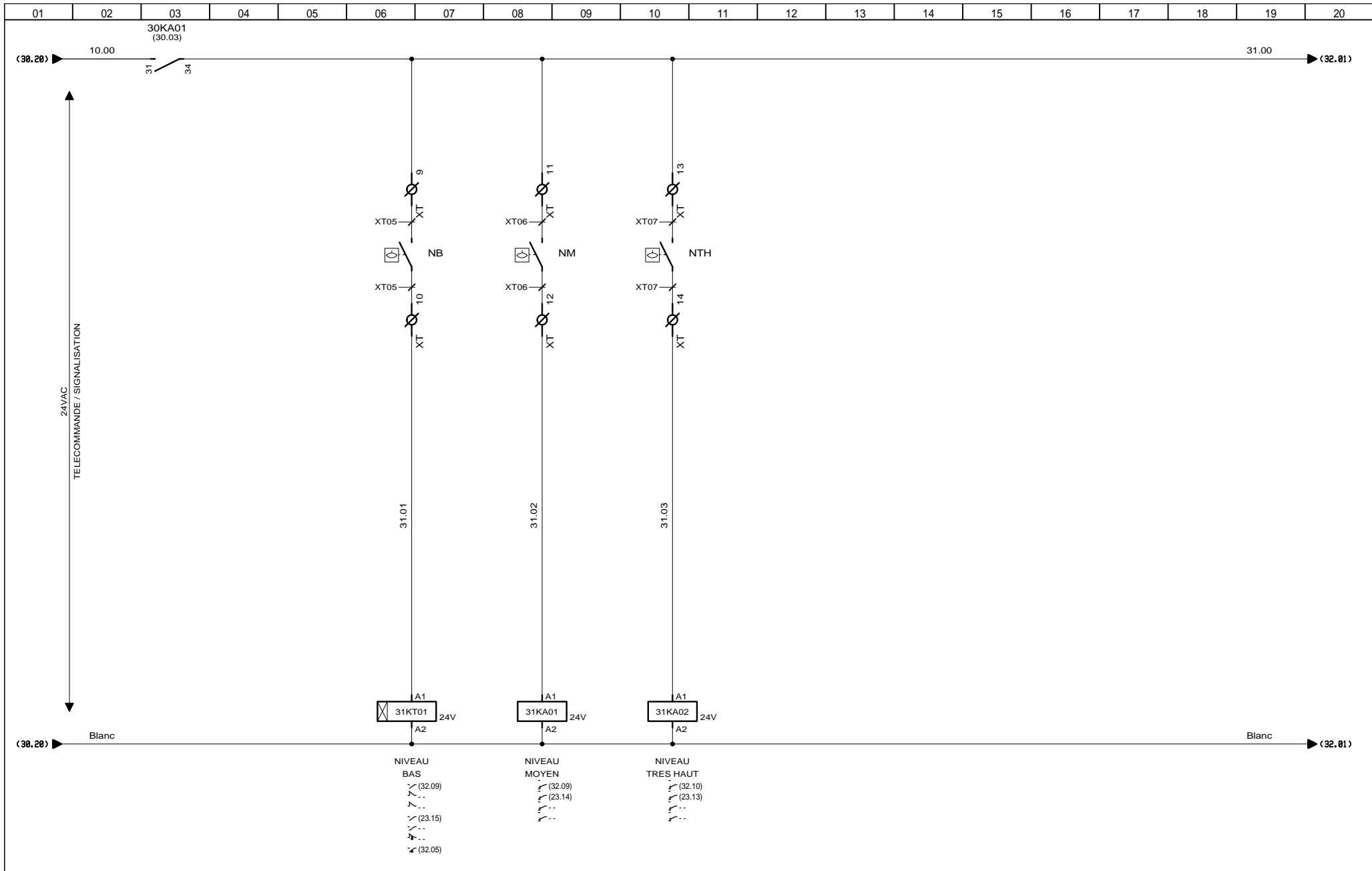

3, Rue Pierre Curie
 91230 MONTGERON
 Tél. : 01.69.52.47.00 - Fax : 01.69.52.47.01
 e-mail : seguin@automatismes-seguin.fr
 http://www.automatismes-seguin.fr

TELECOMMANDE

CLIENT ET NOM DU DOSSIER / CUSTOMER AND NAME OF FOLDER		INDICE / REVIEW
SAUR PR Darvault STEF		0
DESSINATEUR DRAWER	F.CO.	IGE-XAO
N° AFFAIRE N° PROJECT	160327	
FOLIO/SHEET 31/32		VARI SERVICE PACK 7A

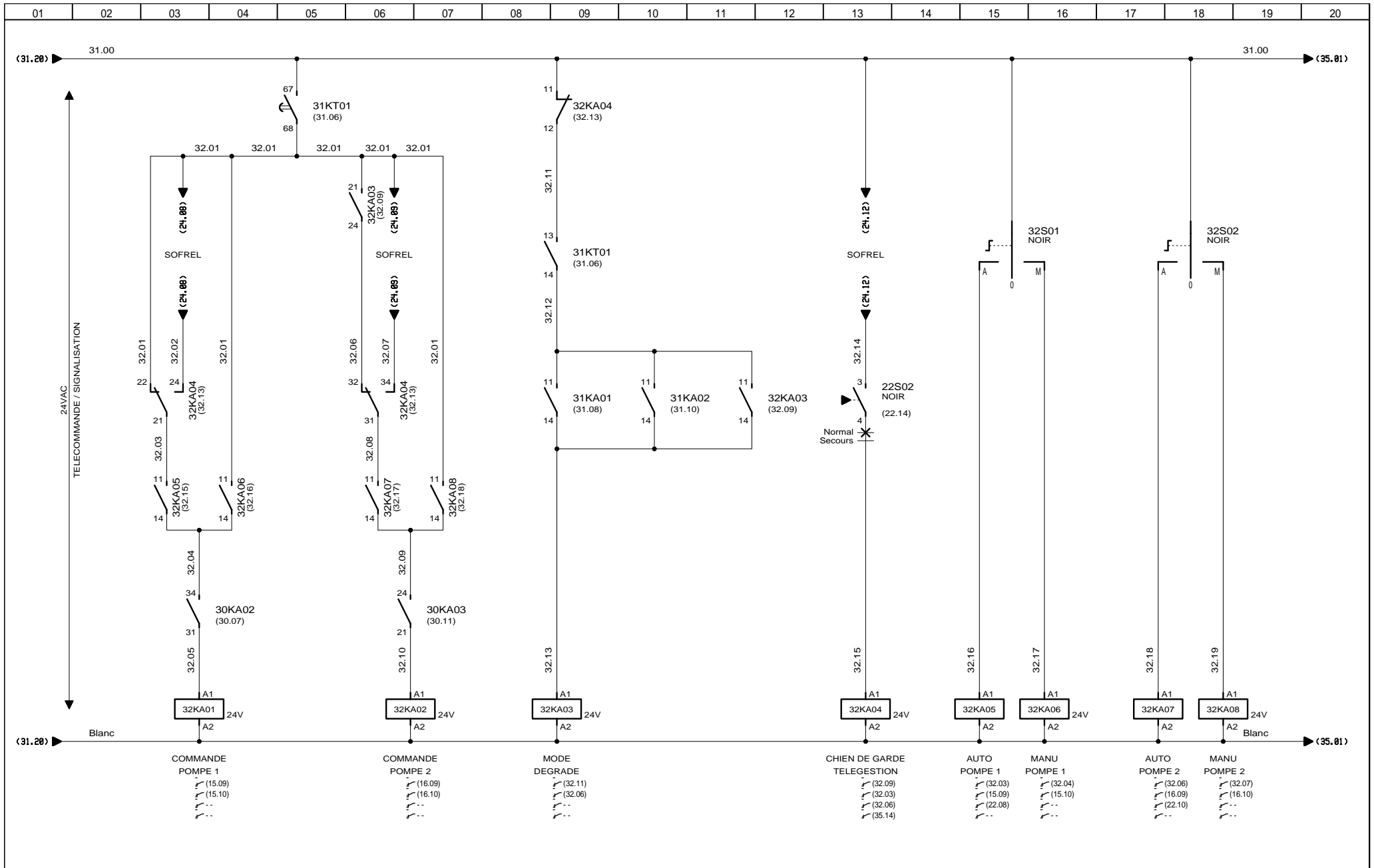

3, Rue Pierre Curie
91230 MONTGERON
Tél. : 01.69.52.47.00 - Fax : 01.69.52.47.01
e-mail : seguin@automatismes-seguin.fr
http://www.automatismes-seguin.fr

TELECOMMANDE

CLIENT ET NOM DU DOSSIER / CUSTOMER AND NAME OF FOLDER		INDICE / REVIEW
SAUR PR Darvault STEF		O
DESSINATEUR DRAWER	F.CO.	IGE-XAO
N° AFFAIRE N° PROJECT	160327	
FOLIO/SHEET		32 / 35
VARI SERVICE PACK 7A		

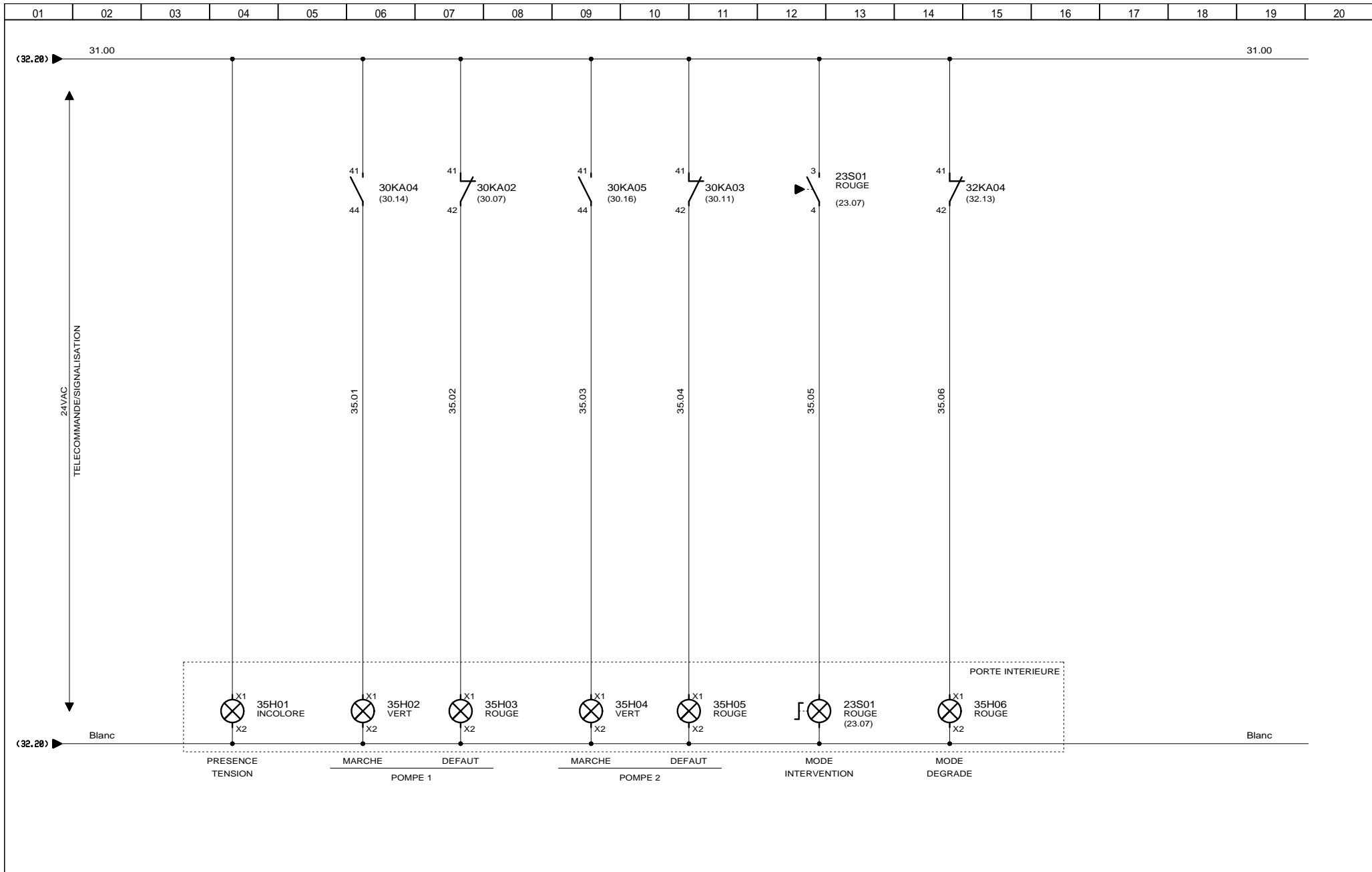

3, Rue Pierre Curie
 91230 MONTGERON
 Tél. : 01.69.52.47.00 - Fax : 01.69.52.47.01
 e-mail : seguin@automatismes-seguin.fr
 http://www.automatismes-seguin.fr

SIGNALISATION

CLIENT ET NOM DU DOSSIER / CUSTOMER AND NAME OF FOLDER		INDICE / REVIEW
SAUR		0
PR Darvault STEF		IGE-XAO
DESSINATEUR DRAWER	F.CO.	FOLIO/SHEET 35 / 40
N° AFFAIRE N° PROJECT	160327	VARI SERVICE PACK 7A

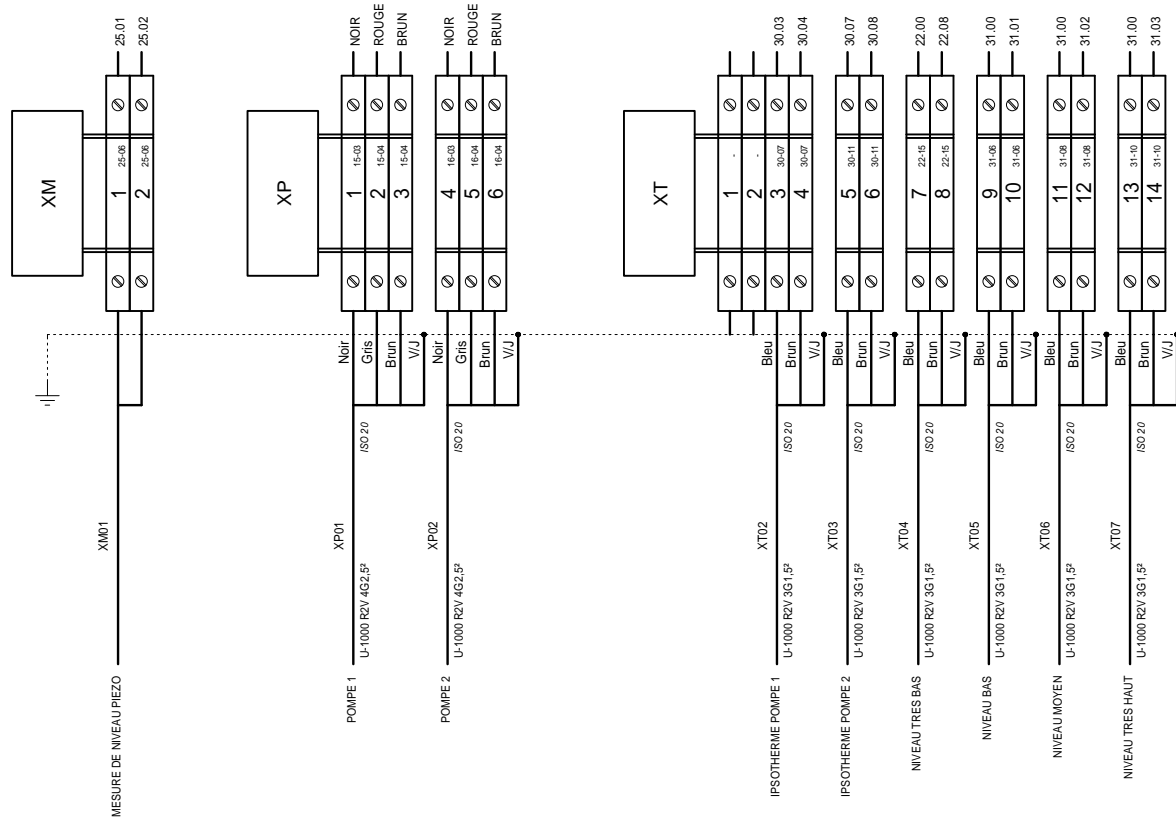

BORNIERS

AUTOMATISMES SEGUIN
 Systeme Qualité
 3, Rue Pierre Curie
 91230 MONTGERON
 Tél. : 01.69.52.47.00 - Fax : 01.69.52.47.01
 e-mail : seguin@automatismes-seguin.fr
 http://www.automatismes-seguin.fr

CLIENT ET NOM DU DOSSIER / CUSTOMER AND NAME OF FOLDER		INDICE / REVIEW
SAUR PR Darvault STEF		0
DESSINATEUR DRAWER	F.CO.	IGE XAO
N° AFFAIRE N° PROJECT	160327	
FOLIO/SHEET 40 / 50		VARI SERVICE PACK 7A

REPERE	DESIGNATION	REFERENCE	MARQUE	QTE
TOLERIE	COFFRET POLYESTER MARINA, IP66/IK10, 1020x810x300 (DIM EXT)	036263	LEGRAND	1
	SOCLE POUR COFFRET MARINA HAUT. 170mm, LARG. 800mm, PROF. 300mm, RAL7035	036292	LEGRAND	1
	TOIT POUR COFFRET MARINA, LARG. 800mm, PROF. 300mm - RAL7035	036295	LEGRAND	1
	PORTE INTERNE POUR COFFRET ATLANTIC/INOX/MARINA 1000x800mm, RAL7035	036364	LEGRAND	1
	POIGNEE ALTIS, ENVELOPPES ATLANTIC/MARINA, AVEC CONDAMNATION 2433A (ACCESS.)	036806	LEGRAND	1
10E01	REPARTITEUR TETRAPOLAIRE TD 40 A, 12 CONNEXIONS	563740	ERICO	1
10E02	BARRETTE DE COUPURE BASSE, PLATINE PLASTIQUE 95x20mm, L = 125mm	034389	LEGRAND	1
10KA01	RELAIS INDUSTRIEL EMBROCHABLE, MONOSTABLE, 4INV, 24VAC + EMBASE	RMIA4524AC + ZMI4SA	CARLO GAVAZZI	1
10PF01	RELAIS DE CONTROLE TRIPHASE POUR L'ORDRE ET LA PERTE DE PHASES, 208-480VAC, 1INV	DPA 51 C M44	CARLO GAVAZZI	1
10QD01	DISJONCTEUR IC60N 3P 1A, 440VAC/25kA, 133VDC/6kA, COURBE C	A9F74301	SCHNEIDER ELECTRIC	1
10QD02	DISJONCTEUR IC60N 2P 2A, 440VAC/25kA, 133VDC/6kA, COURBE C	A9F74202	SCHNEIDER ELECTRIC	1
10QD03	DISJONCTEUR DT40 1P+N 4A 6kA, COURBE C	A9N21022	SCHNEIDER ELECTRIC	1
10QDG01	DISJONCTEUR DE BRANCHEMENT DIFFERENTIEL, 4P, 400VAC, 10/15/20/25/30A, 500mA INSTANTANE	401010	LEGRAND	1
10QIG01	INTERRUPTEUR DIFFERENTIEL IID TYPE AC 415VAC 4P 40A 300mA	A9R14440	SCHNEIDER ELECTRIC	1
10TR01	TRANSFORMATEUR DE COMMANDE ET DE SIGNALISATION MONOPHASEE 230-400V/24-48V, 100VA	044233	LEGRAND	1
12E01	VENTILATEUR A FILTRE 92x92 38m3/h, 230VAC, RAL7035	NSYCVF38M230PF	SCHNEIDER ELECTRIC	1
	GRILLE DE SORTIE POUR VENTILATEUR 92x92, RAL7035	NSYVAG92LPF	SCHNEIDER ELECTRIC	1
12ECH01	RESISTANCE CHAUFFANTE PTC CS 060, 120-240V AC/DC, 50W	06000.0-00	STEGO	1
12ECL01	LAMPE RENTABLE 8W 220V 50-60Hz 400lm	NSYLAM875	SCHNEIDER ELECTRIC	1
12KTH01	PETIT THERMOSTAT KTO 011, 1NF, 0..60°C	01146.9-00	STEGO	1
12KTH02	PETIT THERMOSTAT KTS 011, 1NO, 0..60°C	01141.0-00	STEGO	1
12QD01	DISJONCTEUR DT40 VIGI 1P+N CLASSE AC 16A 30mA COURBE C	A9N21444	SCHNEIDER ELECTRIC	1
12QD02	DISJONCTEUR DT40 1P+N 1A 6kA, COURBE C	A9N21019	SCHNEIDER ELECTRIC	1
12QD03	DISJONCTEUR DT40 1P+N 1A 6kA, COURBE C	A9N21019	SCHNEIDER ELECTRIC	1
12QD04	DISJONCTEUR DT40 1P+N 1A 6kA, COURBE C	A9N21019	SCHNEIDER ELECTRIC	1
12S01	INTERRUPTEUR DE POSITION 1NO+1NF RB, M12 POUSSOIR A GALET, 1m CABLE	XCMD21F2L1	SCHNEIDER ELECTRIC	1
12X01	PRISE DE COURANT 2P+T 10/16A, 250VAC A ECLIPS	004280	LEGRAND	1
15PA01	AMPEREMETRE ROTEX R72A90-A, 0-15A-75A/5A DEV. 90D	192D3302	SOCOMEK	1
15QD01	DISJONCTEUR MOTEUR MAGNETIQUE 18A	GV2L20	SCHNEIDER ELECTRIC	1
	ADDITIF FRONTAL F+O	GVAE11	SCHNEIDER ELECTRIC	1
15UF01	VARIATEUR DE VITESSE ATV 212 POUR MOTEUR, 7.5kW, 380...480V TRI	ATV212HU75N4	SCHNEIDER ELECTRIC	1
16PA01	AMPEREMETRE ROTEX R72A90-A, 0-15A-75A/5A DEV. 90D	192D3302	SOCOMEK	1
16QD01	DISJONCTEUR MOTEUR MAGNETIQUE 18A	GV2L20	SCHNEIDER ELECTRIC	1
	ADDITIF FRONTAL F+O	GVAE11	SCHNEIDER ELECTRIC	1
16UF01	VARIATEUR DE VITESSE ATV 212 POUR MOTEUR, 7.5kW, 380...480V TRI	ATV212HU75N4	SCHNEIDER ELECTRIC	1
20E01	RACK S550 8 EMBLEMES AVEC ALIM SECTEUR 230VAC	T9950A100	SOFREL	1
20E01-01	MODULE DE COMMUNICATION GSM/GPRS-2 + ANTENNE BI-BANDE	V5900521	SOFREL	1
20E01-04	MODULE D'ENTREES, 8E TOR	V5900210	SOFREL	1
20E01-05	MODULE D'ENTREES, 8E TOR	V5900210	SOFREL	1
20E01-06	MODULE DE SORTIES, 4S TOR 1S TOR WDG 50V 1A	V5900310	SOFREL	1
20E01-07	MODULE D'ENTREES, 2E ANA MULTISTANDARD	V5900260	SOFREL	1
20FP01	PROTECTION SECTEUR 230V, 5kA, Up=1.2kV	T5300011	SOFREL	1
20G01	BATTERIE 12V, 7Ah	NP7-12FR	YUASA	1
20QD01	DISJONCTEUR DT40 1P+N 4A 6kA, COURBE C	A9N21022	SCHNEIDER ELECTRIC	1
22S01	CORPS POUSSOIR LUMINEUX	ZB4BW0B45	SCHNEIDER ELECTRIC	1
	TETE POUSSOIR LUMINEUX	ZB4BW343	SCHNEIDER ELECTRIC	1
	CONTACT VIS ETRIER 1NO	ZBE101	SCHNEIDER ELECTRIC	2



3, Rue Pierre Curie
91230 MONTGERON
Tél. : 01.69.52.47.00 - Fax : 01.69.52.47.01
e-mail : seguin@automatismes-seguin.fr
http://www.automatismes-seguin.fr

NOMENCLATURE

CLIENT ET NOM DU DOSSIER / CUSTOMER AND NAME OF FOLDER			INDICE / REVIEW
SAUR PR Darvaut STEF			0
DESSINATEUR DRAWER	F.CO.	FOLIO/SHEET	50 / 51
N° AFFAIRE N° PROJECT	160327		
			IGE XAO VARI SERVICE PACK 7A

REPERE	DESIGNATION	REFERENCE	MARQUE	QTE
22S02	TETE BOUTON TOURNANT 2 POSITIONS	ZB4BD2	SCHNEIDER ELECTRIC	1
	CORPS CONTACT NO	ZB4BZ101	SCHNEIDER ELECTRIC	1
23S01	CORPS BOUTON POSSOIR LUMINEUX TRANSFO 120V	ZB4BW0303	SCHNEIDER ELECTRIC	1
	TETE POUSSOIR LUMINEUX	ZB4BW343	SCHNEIDER ELECTRIC	1
	CONTACT VIS ETRIER 1NO	ZBE101	SCHNEIDER ELECTRIC	1
30KA01	RELAIS INDUSTRIEL EMBROCHABLE, MONOSTABLE, 4INV, 24VAC + EMBASE	RMIA4524AC + ZMI4SA	CARLO GAVAZZI	1
30KA02	RELAIS INDUSTRIEL EMBROCHABLE, MONOSTABLE, 4INV, 24VAC + EMBASE	RMIA4524AC + ZMI4SA	CARLO GAVAZZI	1
30KA03	RELAIS INDUSTRIEL EMBROCHABLE, MONOSTABLE, 4INV, 24VAC + EMBASE	RMIA4524AC + ZMI4SA	CARLO GAVAZZI	1
30KA04	RELAIS INDUSTRIEL EMBROCHABLE, MONOSTABLE, 4INV, 24VAC + EMBASE	RMIA4524AC + ZMI4SA	CARLO GAVAZZI	1
30KA05	RELAIS INDUSTRIEL EMBROCHABLE, MONOSTABLE, 4INV, 24VAC + EMBASE	RMIA4524AC + ZMI4SA	CARLO GAVAZZI	1
30KT01	RELAIS TEMPORISE ELECTRONIQUE STATIQUE AU TRAVAIL 0.1-100h, 24-240V AC/DC	RE17LAMW	SCHNEIDER ELECTRIC	1
30PCH01	COMPTEUR HORAIRE TOTALISATEUR 10...30V, 50Hz	3.220.401.071	KUBLER	1
	CADRE POUR COMPTEUR DIN H57	T008171	KUBLER	1
30PCH02	COMPTEUR HORAIRE TOTALISATEUR 10...30V, 50Hz	3.220.401.071	KUBLER	1
	CADRE POUR COMPTEUR DIN H57	T008171	KUBLER	1
31KA01	RELAIS INDUSTRIEL EMBROCHABLE, MONOSTABLE, 4INV, 24VAC + EMBASE	RMIA4524AC + ZMI4SA	CARLO GAVAZZI	1
31KA02	RELAIS INDUSTRIEL EMBROCHABLE, MONOSTABLE, 4INV, 24VAC + EMBASE	RMIA4524AC + ZMI4SA	CARLO GAVAZZI	1
31KT01	CONTACTEUR AUXILIAIRE MODELE D 24AC	CAD32B7	SCHNEIDER ELECTRIC	1
	BLOC DE CONTACTS AUXILIAIRES TEMPORISES 0,1...30s POUR CONTACTEUR MODELE D	LADT2	SCHNEIDER ELECTRIC	1
32KA01	RELAIS INDUSTRIEL EMBROCHABLE, MONOSTABLE, 4INV, 24VAC + EMBASE	RMIA4524AC + ZMI4SA	CARLO GAVAZZI	1
32KA02	RELAIS INDUSTRIEL EMBROCHABLE, MONOSTABLE, 4INV, 24VAC + EMBASE	RMIA4524AC + ZMI4SA	CARLO GAVAZZI	1
32KA03	RELAIS INDUSTRIEL EMBROCHABLE, MONOSTABLE, 4INV, 24VAC + EMBASE	RMIA4524AC + ZMI4SA	CARLO GAVAZZI	1
32KA04	RELAIS INDUSTRIEL EMBROCHABLE, MONOSTABLE, 4INV, 24VAC + EMBASE	RMIA4524AC + ZMI4SA	CARLO GAVAZZI	1
32KA05	RELAIS INDUSTRIEL EMBROCHABLE, MONOSTABLE, 4INV, 24VAC + EMBASE	RMIA4524AC + ZMI4SA	CARLO GAVAZZI	1
32KA06	RELAIS INDUSTRIEL EMBROCHABLE, MONOSTABLE, 4INV, 24VAC + EMBASE	RMIA4524AC + ZMI4SA	CARLO GAVAZZI	1
32KA07	RELAIS INDUSTRIEL EMBROCHABLE, MONOSTABLE, 4INV, 24VAC + EMBASE	RMIA4524AC + ZMI4SA	CARLO GAVAZZI	1
32KA08	RELAIS INDUSTRIEL EMBROCHABLE, MONOSTABLE, 4INV, 24VAC + EMBASE	RMIA4524AC + ZMI4SA	CARLO GAVAZZI	1
32S01	TETE BOUTON TOURNANT 3 POSITIONS	ZB4BD3	SCHNEIDER ELECTRIC	1
	CORPS CONTACT 2NO	ZB4BZ103	SCHNEIDER ELECTRIC	1
32S02	TETE BOUTON TOURNANT 3 POSITIONS	ZB4BD3	SCHNEIDER ELECTRIC	1
	CORPS CONTACT 2NO	ZB4BZ103	SCHNEIDER ELECTRIC	1
35H01	VOYANT INCOLORE DEL 24V	XB7EV07BP	SCHNEIDER ELECTRIC	1
35H02	VOYANT VERT DEL 24V	XB7EV03BP	SCHNEIDER ELECTRIC	1
35H03	VOYANT ROUGE DEL 24V	XB7EV04BP	SCHNEIDER ELECTRIC	1
35H04	VOYANT VERT DEL 24V	XB7EV03BP	SCHNEIDER ELECTRIC	1
35H05	VOYANT ROUGE DEL 24V	XB7EV04BP	SCHNEIDER ELECTRIC	1
35H06	VOYANT ROUGE DEL 24V	XB7EV04BP	SCHNEIDER ELECTRIC	1



3, Rue Pierre Curie
91230 MONTGERON
Tél. : 01.69.52.47.00 - Fax : 01.69.52.47.01
e-mail : seguin@automatismes-seguin.fr
http://www.automatismes-seguin.fr

NOMENCLATURE

CLIENT ET NOM DU DOSSIER / CUSTOMER AND NAME OF FOLDER			INDICE / REVIEW
SAUR			0
PR Darvault STEF			
DESSINATEUR DRAWER	F.CO.	FOLIO/SHEET	51 / 51
N° AFFAIRE N° PROJECT	160327		
			IGE XAO VARI SERVICE PACK 7A