

|              |              |                         |                            |                           |                             |
|--------------|--------------|-------------------------|----------------------------|---------------------------|-----------------------------|
|              |              |                         |                            |                           |                             |
|              |              |                         |                            |                           |                             |
|              |              |                         |                            |                           |                             |
|              |              |                         |                            |                           |                             |
|              |              |                         |                            |                           |                             |
|              |              |                         |                            |                           |                             |
|              |              |                         |                            |                           |                             |
|              |              |                         |                            |                           |                             |
|              |              |                         |                            |                           |                             |
|              |              |                         |                            |                           |                             |
| 14/03/2017   | 0            | M.D.                    | RETOUR ESSAIS              | F.C.                      | E.A.                        |
| 27/01/2017   | A            | K.C.                    | PREMIERE EMISSION          | F.C.                      | E.A.                        |
| DATE<br>DATE | REV.<br>REV. | DESSINE PAR<br>DRAWN BY | MODIFICATIONS<br>REVISIONS | VERIFIE PAR<br>CHECKED BY | APPROUVE PAR<br>APPROVED BY |

***SCHEMA ELECTRIQUE  
ELECTRICAL DRAWING***



3, Rue Pierre Curie  
91230 MONTGERON  
Tél. : 01.69.52.47.00 - Fax : 01.69.52.47.01  
e-mail : [seguin@automatismes-seguin.fr](mailto:seguin@automatismes-seguin.fr)  
<http://www.automatismes-seguin.fr>

|              |        |
|--------------|--------|
| PLAN: 170039 | REV: 0 |
| CDE:         |        |

Ce document est notre propriété. Il ne peut être reproduit et / ou communiqué sans autorisation.  
This document is our property. It cannot be reproduced and / or transmitted without authorization.



***Armoire PR Bichereau - THOURY FEROTTES***



LETTRE DE REPERAGE DES ELEMENTS DU SCHEMA

|     |                      |      |                           |     |                        |     |                           |
|-----|----------------------|------|---------------------------|-----|------------------------|-----|---------------------------|
| QI  | INTERRUPTEUR         | PCPI | CONTROLEUR D'ISOLEMENT    | KT  | RELAIS TEMPORISE       | SA  | COMMUTATEUR D'AMPEREMETRE |
| QIG | INTERRUPTEUR GENERAL | TR   | TRANSFORMATEUR DE TENSION | KAU | RELAIS ARRET D'URGENCE | SV  | COMMUTATEUR DE VOLTMETRE  |
| QD  | DISJONCTEUR          | TC   | TRANSFORMATEUR DE COURANT | UF  | VARIATEUR              | ECH | RESISTANCE CHAUFFANTE     |
| QDG | DISJONCTEUR GENERAL  | U    | ONDULEUR, ALIMENTATION    | UM  | DEMARREUR              | ECL | ECLAIRAGE                 |
| FP  | PARAFONDRE           | KIC  | INTER CREPUSCULAIRE       | S   | ORGANE DE COMMANDE     | G   | BATTERIE                  |
| FU  | FUSIBLE              | KIH  | HORLOGE                   | H   | VOYANT, SIRENE         | P   | INSTRUMENTATION           |
| F   | THERMIQUE            | KTH  | THERMOSTAT                | PCH | COMPTEUR HORAIRE       | X   | PRISE DE COURANT, BORNIER |
| QF  | SECTIONNEUR FUSIBLE  | KM   | CONTACTEUR                | PA  | AMPEREMETRE            | E   | MATERIELS AUTRES          |
| PF  | CONTROLEUR DE PHASE  | KA   | RELAIS                    | PV  | VOLTMETRE              | KTL | TELERUPTEUR               |

LETTER CODES FOR ITEMS DESIGNATION ON THE DRAWING

|     |                      |      |                       |     |                      |     |                        |
|-----|----------------------|------|-----------------------|-----|----------------------|-----|------------------------|
| QI  | SWITCH               | PCPI | INSULATION CONTROLLER | KT  | TEMPORIZES RELAY     | SA  | AMPEREMETER SWITCH     |
| QIG | GENERAL SWITCH       | TR   | TENSION TRANSFORMER   | KAU | EMERGENCY STOP RELAY | SV  | VOLTMETER SWITCH       |
| QD  | BREAKER              | TC   | CURRENT TRANSFORMER   | UF  | VELOCITY VARIATOR    | ECL | LIGHT                  |
| QDG | GENERAL BREAKER      | U    | INVERTER, SUPPLY      | UM  | MOTOR STARTER        | ECH | HEATER                 |
| FP  | LIGHTNING PROTECTOR  | KIC  | DIMMER                | S   | CONTROL UNIT         | G   | BATTERY                |
| FU  | FUSE                 | KIH  | CLOCK                 | H   | INDICATOR            | P   | INSTRUMENTATION        |
| F   | THERMAL RELAY        | KTH  | THERMOSTAT            | PCH | TIMER                | X   | SOCKET, TERMINAL BLOCK |
| QF  | DISCONNECTING SWITCH | KM   | CONTACTOR             | PA  | AMPEREMETER          | E   | OTHER EQUIPMENTS       |
| PF  | PHASE CONTROLLER     | KA   | RELAY                 | PV  | VOLTMETER            | KTL | TELEBREAKER            |

COULEURS DE FILS

TRI 400V: <= 6 mm2 Noir Rouge Brun  
> 6 mm2 Noir Bagué Noir Rouge Brun

NEUTRE: Bleu Clair

230VAC: Rouge avec Commun Bobines Blanc (\*)

230VAC ONDULE: Neutre Bleu Clair Bagué Orange  
Phase Noir Bagué Orange

110VAC: Noir avec Commun Bobines Blanc (\*)

24VAC: Violet avec Commun Bobines Blanc (\*)

24VDC: Bleu Foncé avec Commun Bobines Blanc (\*)

48VAC: Violet avec Commun Bobines Blanc (\*)

48VDC: Bleu Foncé avec Commun Bobines Blanc (\*)

REPORTS: Orange

TERRE: Vert/Jaune

ANALOGIQUE: Une Paire + Brun - Blanc  
Unifilaire Blanc

TENSION EXTERNE PERMANENTE INTER GENERAL OUVERT: Orange

ATTENTION

Si plusieurs tensions de télécommande, alors prendre uniquement le 230VAC avec Commun Bobines Blanc

(\*) Si Télécommande

WIRE COLOR

TRI 400V: <= 6 mm2 Black Red Brown  
> 6 mm2 Black with Ring Black Red Brown

NEUTRE: Light Blue

230VAC: Red with Spods Common White (\*)

230VAC UPS: Neutre Light Blue with Ring Orange  
Phase Black with Ring Orange

110VAC: Black with Spods Common White (\*)

24VAC: Purple with Spods Common White (\*)

24VDC: Dark Bleu with Spods Common White (\*)

48VAC: Purple with Spods Common White (\*)

48VDC: Dark Bleu with Spods Common White (\*)

REPORTS: Orange

GROUND: Green/Yellow

ANALOGICAL: One Pair + Brown - White  
Unifilar White

PERMANENTLY EXTERNAL POWER GENERAL BREAKER OPEN: Orange

CAUTION

If There are Several Tensions of Command Then to take Only the 230VAC with Spods Common White

(\*) If Command

TYPE DE RELAIS ET DE CONTACT DANS LE SCHEMA

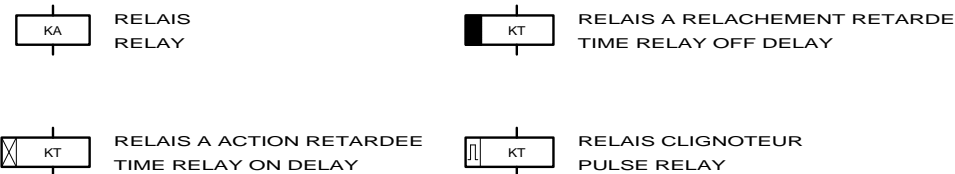

RELAY AND CONTACT TYPE IN THE DRAWING

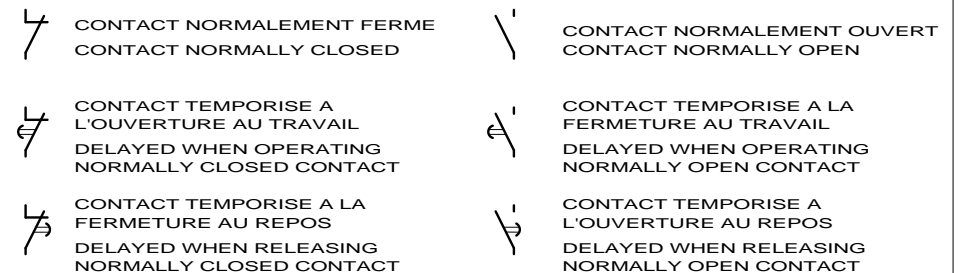

LE SCHEMA EST REPRESENTE HORS TENSION ET GENERATEUR HORS SERVICE

THE DRAWING IS SHOWN OUT OF VOLTAGE AND WITH GENERATOR OUT OF SERVICE



3, Rue Pierre Curie  
91230 MONTGERON  
Tél. : 01.69.52.47.00 - Fax : 01.69.52.47.01  
e-mail : seguin@automatismes-seguin.fr  
http://www.automatismes-seguin.fr

LEGENDE DU SCHEMA ELECTRIQUE

|  |        |                          |
|--|--------|--------------------------|
| CLIENT ET NOM DU DOSSIER / CUSTOMER AND NAME OF FOLDER |        | INDICE / REVIEW          |
| SAUR   |        | 0                        |
| Armoire PR Bichereau - THOURY FEROTTES                 |        | <br>VARI SERVICE PACK 7A |
| DESSINATEUR DRAWER                                     | K.C.   |                          |
| N° AFFAIRE N° PROJECT                                  | 170039 |                          |
| FOLIO/SHEET 03/04                                      |        |                          |

CODE DU REPERAGE

LETTER CODE

1/ DES APPAREILS DANS LES ARMOIRES  
APPARATUS IN THE CABINETS



52 KA 01

N° D'ORDRE DANS LE FOLIO D'ORIGINE  
ORDER NUMBER ON ORIGINAL SHEET

LETTRE DE REPERAGE  
LETTER CODES FOR ITEM

N° DU FOLIO D'ORIGINE  
ORIGINAL SHEET NUMBER

2/ DES FILS DE CABLAGE  
WIRING

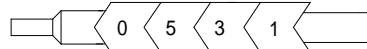

N° DU FOLIO D'ORIGINE  
ORIGINAL SHEET NUMBER

N° DU FIL DANS LE FOLIO D'ORIGINE  
NUMBER OF THE WIRE ON ORIGINAL SHEET

3/ REPORT DES CONTACTS DANS LE SCHEMA  
CONTACT REPORT IN THE DRAWING



17.29

N° DE LA COLONNE OU EST UTILISE LE CONTACT  
COLUMN NUMBER WHERE THE CONTACT IS USED

N° DU FOLIO OU EST UTILISE LE CONTACT  
SHEET NUMBER WHERE THE CONTACT IS USED

4/ REPRESENTATION DES BORNES ET BORNIERES DANS LE SCHEMA  
BINDINGS SCREWS VIEW IN THE DRAWING



N° D'ORDRE (SI NECESSAIRE)  
ORDER NUMBER (IF NECESSARY)

NATURE DU BORNIER  
NATURE OF TERMINAL BLOCK

- A : ALIMENTATION
- P : PUISSANCE
- T : TELECOMMANDE
- M : MESURE
- R : REPORTS



LE SCHEMA EST REPRESENTE HORS TENSION ET GENERATEUR HORS SERVICE

THE DRAWING IS SHOWN OUT OF VOLTAGE AND WITH GENERATOR OUT OF SERVICE



3, Rue Pierre Curie  
91230 MONTGERON  
Tél. : 01.69.52.47.00 - Fax : 01.69.52.47.01  
e-mail : seguin@automatismes-seguin.fr  
http://www.automatismes-seguin.fr

### LEGENDE DU SCHEMA ELECTRIQUE

|  |        |                      |
|--|--------|----------------------|
| CLIENT ET NOM DU DOSSIER / CUSTOMER AND NAME OF FOLDER |        | INDICE / REVIEW      |
| SAUR   |        | 0                    |
| Armoire PR Bichereau - THOURY FEROTTES                 |        | IGE-XAO              |
| DESSINATEUR<br>DRAWER                                  | K.C.   |                      |
| N° AFFAIRE<br>N° PROJECT                               | 170039 | FOLIO/SHEET 04/06    |
|  |        | VARI SERVICE PACK 7A |

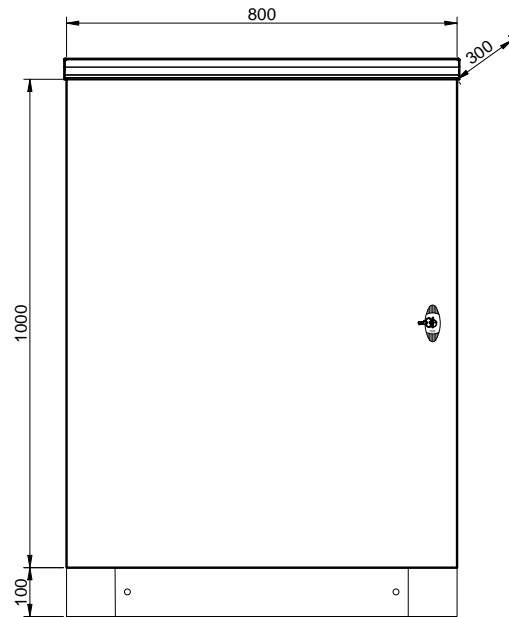

3, Rue Pierre Curie  
 91230 MONTGERON  
 Tél. : 01.69.52.47.00 - Fax : 01.69.52.47.01  
 e-mail : seguin@automatismes-seguin.fr  
 http://www.automatismes-seguin.fr

### IMPLANTATION FACADE

|  |        |                                 |
|--|--------|---------------------------------|
| CLIENT ET NOM DU DOSSIER / CUSTOMER AND NAME OF FOLDER |        | INDICE / REVIEW                 |
| SAUR   |        | 0                               |
| Armoire PR Bichereau - THOURY FEROTTES                 |        |                                 |
| DESSINATEUR<br>DRAWER                                  | K.C.   | FOLIO/SHEET 06/07               |
| N° AFFAIRE<br>N° PROJECT                               | 170039 |                                 |
|  |        | IGE XAO<br>VARI SERVICE PACK 7A |

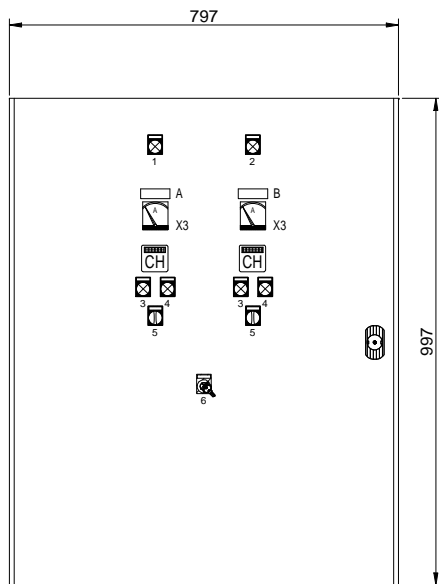

IMPLANTATION FACADE  
PORTE INTERIEURE

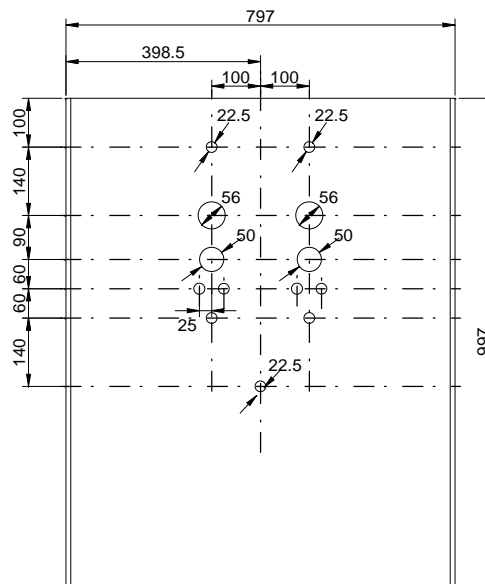

PLAN DE COUPE  
PORTE INTERIEURE

**ETIQUETTES 60x20**

- A - POMPE 1
- B - POMPE 2

**ETIQUETTES SCHNEIDER**

- 1 - PRESENCE TENSION
- 2 - NIVEAU TROP PLEIN
- 3 - MARCHÉ
- 4 - DEFAUT
- 5 - AUTO / 0 / MAIN
- 6 - INTERVENTION 0 / 1



3, Rue Pierre Curie  
91230 MONTGERON  
Tél. : 01.69.52.47.00 - Fax : 01.69.52.47.01  
e-mail : seguin@automatismes-seguin.fr  
http://www.automatismes-seguin.fr

**IMPLANTATION PORTE INTERIEURE**

|  |        |                          |
|--|--------|--------------------------|
| CLIENT ET NOM DU DOSSIER / CUSTOMER AND NAME OF FOLDER |        | INDICE / REVIEW          |
| SAUR   |        | 0                        |
| Armoire PR Bichereau - THOURY FEROTTES                 |        | <br>V4R1 SERVICE PACK 7A |
| DESSINATEUR<br>DRAWER                                  | K.C.   |                          |
| N° AFFAIRE<br>N° PROJECT                               | 170039 |                          |
| FOLIO/SHEET  |        | 07 / 10                  |

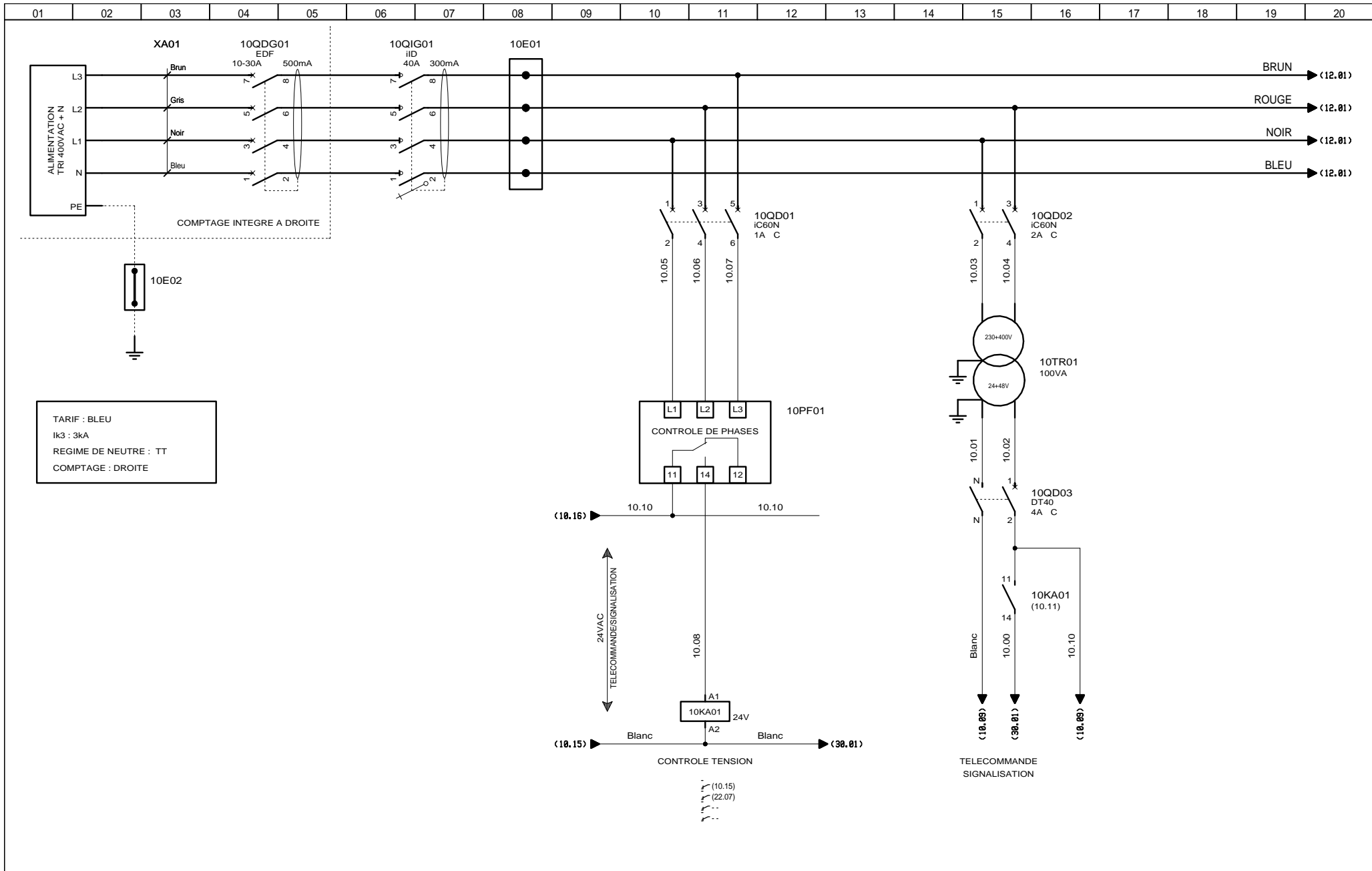

### DISTRIBUTION 400VAC

|  |        |                      |
|--|--------|----------------------|
| CLIENT ET NOM DU DOSSIER / CUSTOMER AND NAME OF FOLDER |        | INDICE / REVIEW      |
| SAUR   |        | 0                    |
| Armoire PR Bichereau - THOURY FEROTTES                 |        |                      |
| DESSINATEUR<br>DRAWER                                  | K.C.   | FOLIO/SHEET 10 / 12  |
| N° AFFAIRE<br>N° PROJECT                               | 170039 |                      |
|  |        | VARI SERVICE PACK 7A |

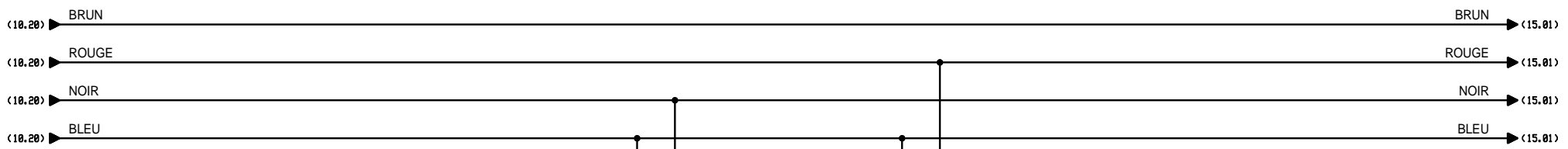

400VAC + N

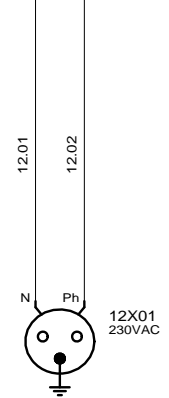
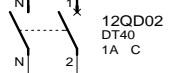
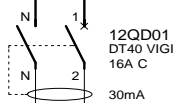

PRISE DE COURANT  
ARMOIRE

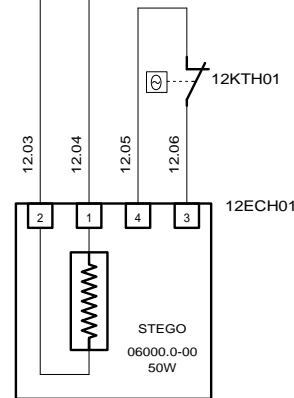

CHAUFFAGE  
ARMOIRE



3, Rue Pierre Curie  
91230 MONTGERON  
Tél. : 01.69.52.47.00 - Fax : 01.69.52.47.01  
e-mail : seguin@automatismes-seguin.fr  
http://www.automatismes-seguin.fr

## DISTRIBUTION 400VAC UTILITES

|  |        |                      |
|--|--------|----------------------|
| CLIENT ET NOM DU DOSSIER / CUSTOMER AND NAME OF FOLDER |        | INDICE / REVIEW      |
| SAUR   |        | 0                    |
| Armoire PR Bichereau - THOURY FEROTTES                 |        |                      |
| DESSINATEUR<br>DRAWER                                  | K.C.   | FOLIO/SHEET 12 / 15  |
| N° AFFAIRE<br>N° PROJECT                               | 170039 |                      |
|  |        | VARI SERVICE PACK 7A |

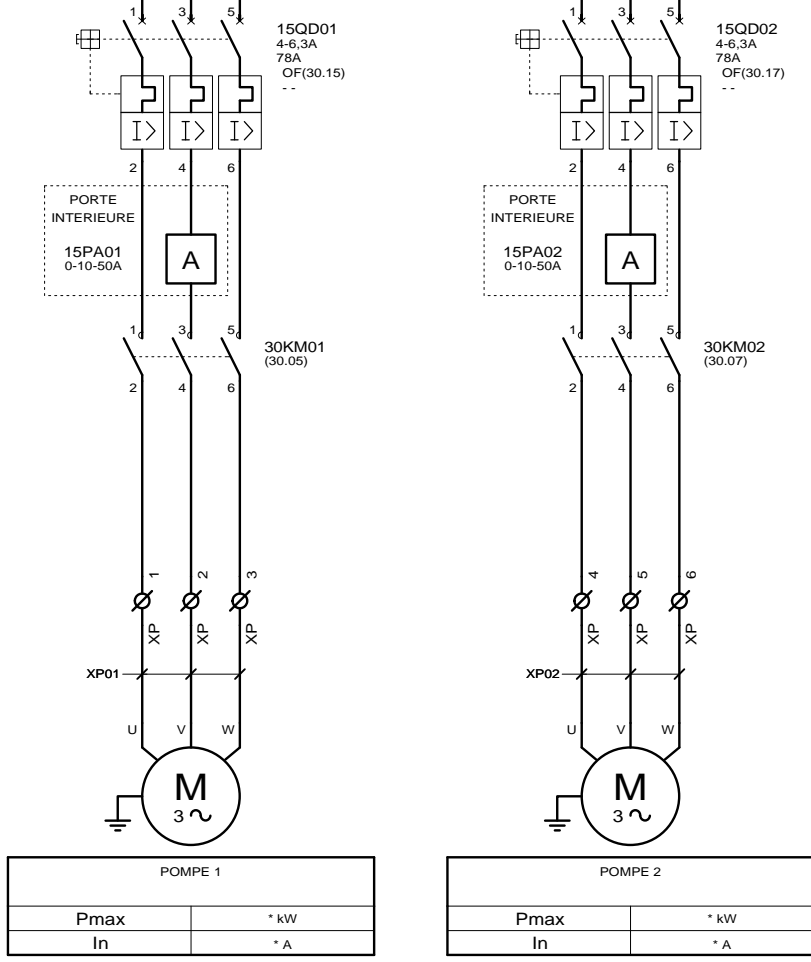
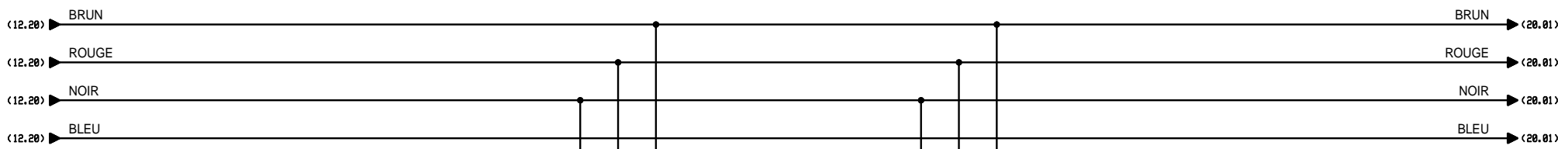

| POMPE 1 |      |
|---------|------|
| Pmax    | * kW |
| In      | * A  |

| POMPE 2 |      |
|---------|------|
| Pmax    | * kW |
| In      | * A  |

**AUTOMATISMES SEGUIN**  
 Systeme Qualité  
 3, Rue Pierre Curie  
 91230 MONTGERON  
 Tél. : 01.69.52.47.00 - Fax : 01.69.52.47.01  
 e-mail : seguin@automatismes-seguin.fr  
 http://www.automatismes-seguin.fr

### PUISSANCE POMPES

| CLIENT ET NOM DU DOSSIER / CUSTOMER AND NAME OF FOLDER |        |                      |
|--|--------|----------------------|
| SAUR   |        |                      |
| Armoire PR Bichereau - THOURY FEROTTES                 |        |                      |
| DESSINATEUR<br>DRAWER                                  | K.C.   | INDICE / REVIEW<br>0 |
| N° AFFAIRE<br>N° PROJECT                               | 170039 | IGE XAO              |
| FOLIO/SHEET 15 / 20                                    |        | VARI SERVICE PACK 7A |

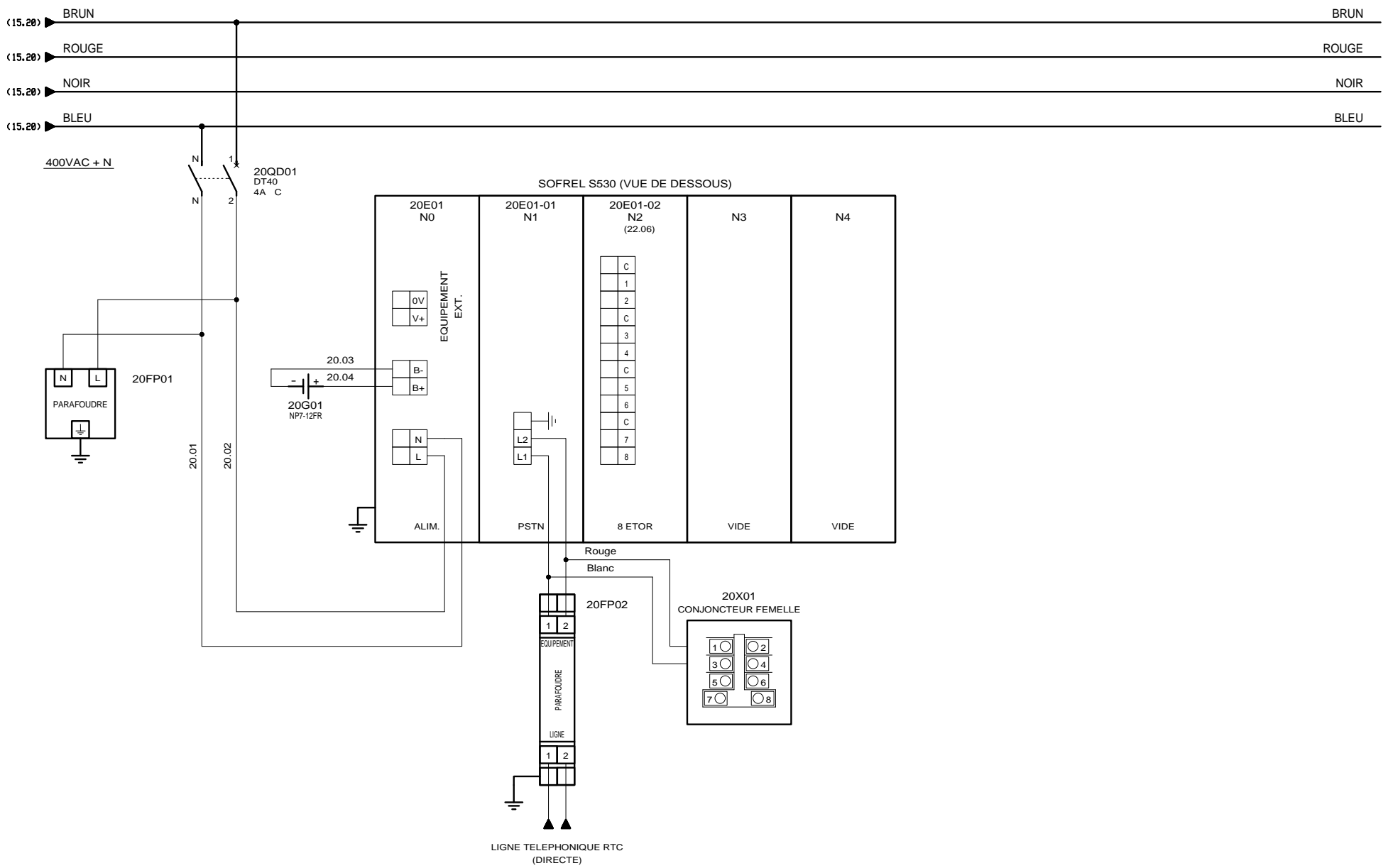

### ALIMENTATION SOFREL S530

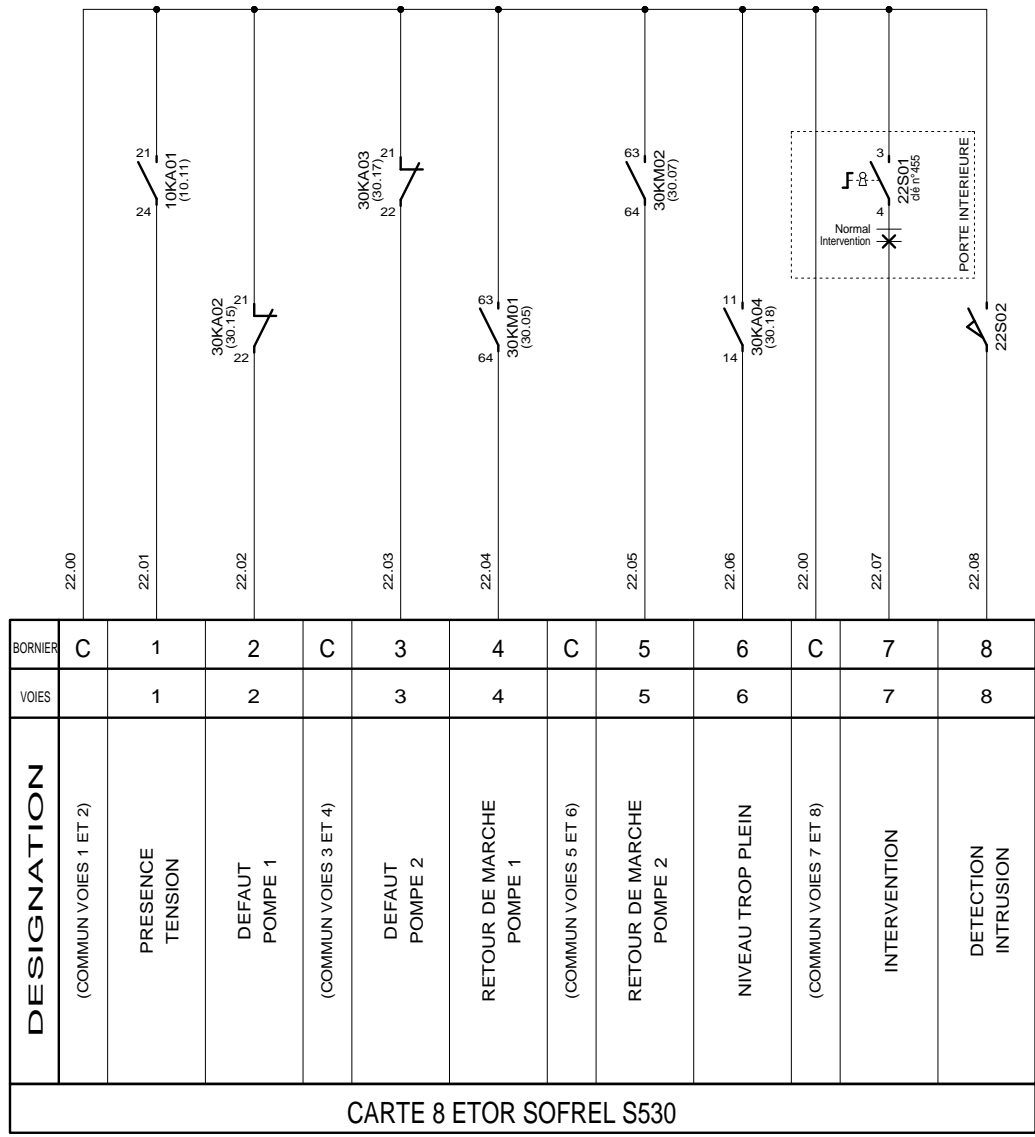

20E01-02  
(20.09)

### CARTE 8 ENTrees TOR EMPLACEMENT 2

|  |        |                      |
|--|--------|----------------------|
| CLIENT ET NOM DU DOSSIER / CUSTOMER AND NAME OF FOLDER |        | INDICE / REVIEW      |
| SAUR<br>Armoire PR Bichereau - THOURY FEROTTES         |        | 0                    |
| DESSINATEUR<br>DRAWER                                  | K.C.   | FOLIO/SHEET 22 / 30  |
| N° AFFAIRE<br>N° PROJECT                               | 170039 |                      |
|  |        | VARI SERVICE PACK 7A |

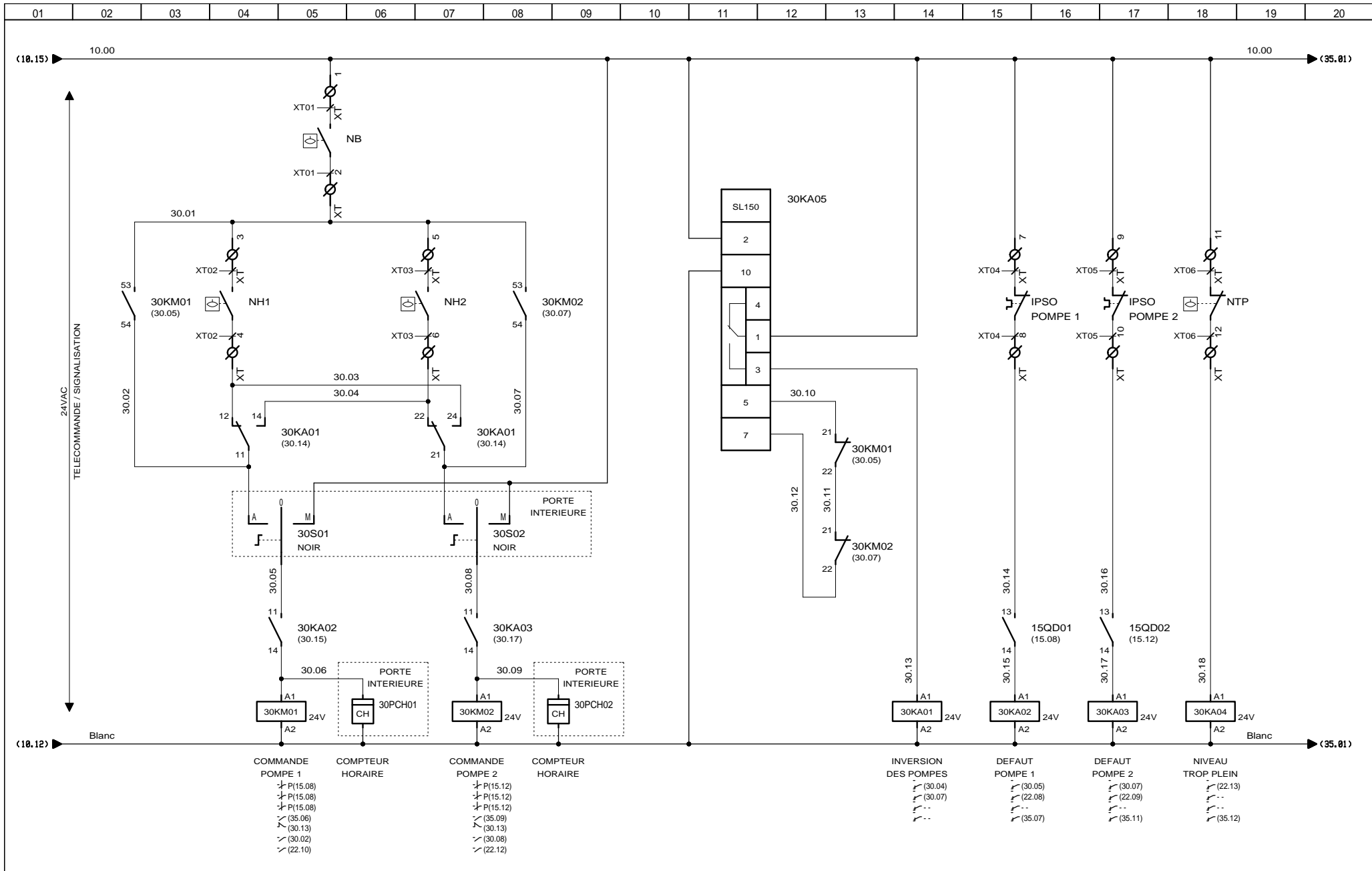

3, Rue Pierre Curie  
91230 MONTGERON  
Tél. : 01.69.52.47.00 - Fax : 01.69.52.47.01  
e-mail : seguin@automatismes-seguin.fr  
http://www.automatismes-seguin.fr

## TELECOMMANDE POMPES

|  |        |                      |
|--|--------|----------------------|
| CLIENT ET NOM DU DOSSIER / CUSTOMER AND NAME OF FOLDER |        | INDICE / REVIEW      |
| SAUR   |        | 0                    |
| Armoire PR Bichereau - THOURY FEROTTES                 |        |                      |
| DESSINATEUR<br>DRAWER                                  | K.C.   | IGE-XAO              |
| N° AFFAIRE<br>N° PROJECT                               | 170039 | FOLIO/SHEET 30 / 35  |
|  |        | V4R1 SERVICE PACK 7A |

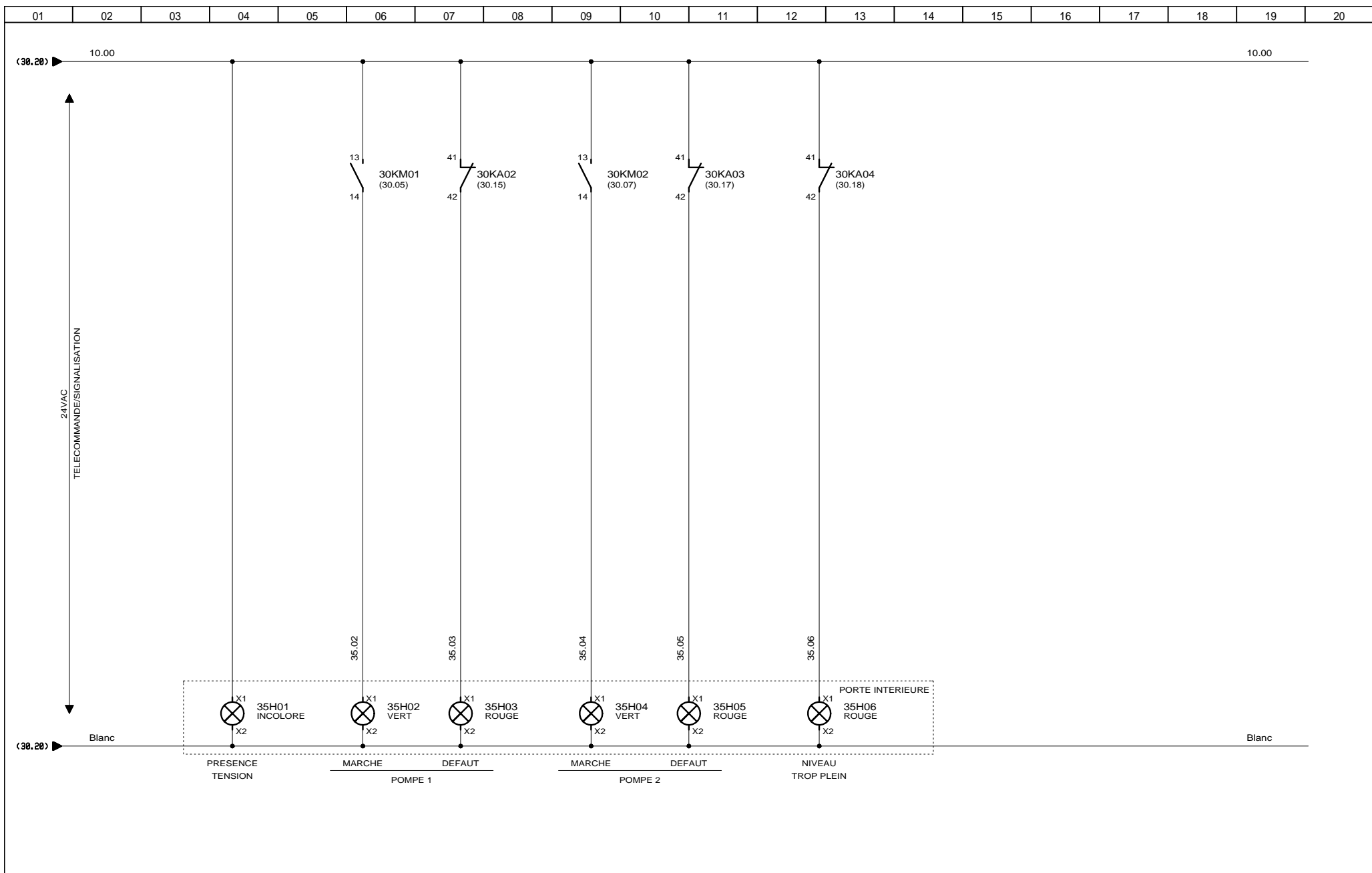

3, Rue Pierre Curie  
91230 MONTGERON  
Tél. : 01.69.52.47.00 - Fax : 01.69.52.47.01  
e-mail : [seguin@automatismes-seguin.fr](mailto:seguin@automatismes-seguin.fr)  
<http://www.automatismes-seguin.fr>

## SIGNALISATION

|  |        |                      |
|--|--------|----------------------|
| CLIENT ET NOM DU DOSSIER / CUSTOMER AND NAME OF FOLDER |        | INDICE / REVIEW      |
| SAUR   |        | 0                    |
| Armoire PR Bichereau - THOURY FEROTTES                 |        |                      |
| DESSINATEUR<br>DRAWER                                  | K.C.   |                      |
| N° AFFAIRE<br>N° PROJECT                               | 170039 |                      |
| FOLIO/SHEET 35 / 40                                    |        | VARI SERVICE PACK 7A |

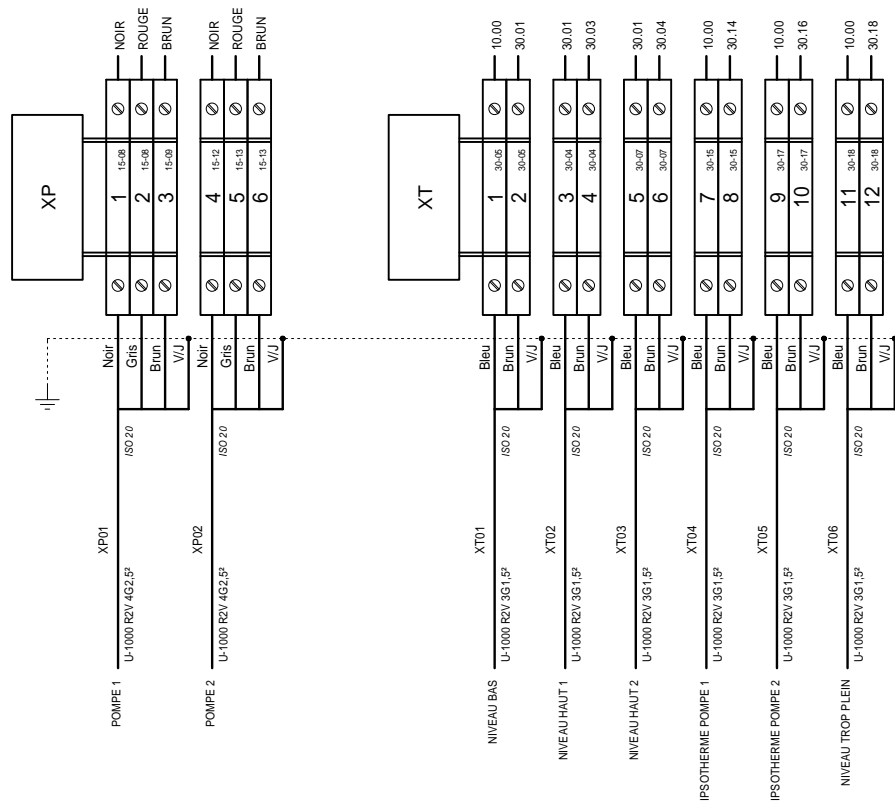

### BORNERS

|  |        |                      |
|--|--------|----------------------|
| CLIENT ET NOM DU DOSSIER / CUSTOMER AND NAME OF FOLDER |        | INDICE / REVIEW      |
| SAUR   |        | 0                    |
| Armoire PR Bichereau - THOURY FEROTTES                 |        |                      |
| DESSINATEUR<br>DRAWER                                  | K.C.   | IGE XAO              |
| N° AFFAIRE<br>N° PROJECT                               | 170039 | FOLIO/SHEET 40/50    |
|  |        | VARI SERVICE PACK 7A |

| REPERE   | DESIGNATION  | REFERENCE           | MARQUE             | QTE |
|----------|--|---------------------|--------------------|-----|
| TOLERIE  | COFFRET UNIVERSEL AVEC PORTE PLEINE SANS CHASSIS 1000x800x300, IP66, RAL7035           | NSYS3D10830         | SCHNEIDER ELECTRIC | 1   |
|          | POCHETTE OUVERTE POUR PLANS AUTOCOLLANTE, 340x235mm (ACC D'ENVELOPPES)                 | 036580              | LEGRAND            | 1   |
|          | TABLEAU DE COMPTAGE TRI + NEUTRE AVEC CCPI SANS AGCP 830x250                           | 48 030              | SEIFEL             | 1   |
|          | POIGNEE A CLE 1242E  | NSYAEDL1242S3D      | SCHNEIDER ELECTRIC | 1   |
|          | FIXATION SOCLE POUR COFFRET  | NSYAPFWM            | SCHNEIDER ELECTRIC | 1   |
|          | PORTE INTERNE POUR COFFRET H1000xL800  | NSYPIN108           | SCHNEIDER ELECTRIC | 1   |
|          | SOCLE FRONTAL SF/SM 100x800  | NSYSPF8100          | SCHNEIDER ELECTRIC | 1   |
|          | JEU DE 2 TRAPPES LATERALES SOCLE SD 100X300  | NSYS3100SD          | SCHNEIDER ELECTRIC | 1   |
|          | AUVENT POUR COFFRET L800xP300  | NSYTJ8030           | SCHNEIDER ELECTRIC | 1   |
| 10E01    | REPARTITEUR TETRAPOLAIRE TD 40 A, 12 CONNEXIONS  | 563740              | ERICO              | 1   |
| 10E02    | BARRETTE DE COUPURE BASSE, PLATINE PLASTIQUE 95x20mm, L = 125mm                        | 034389              | LEGRAND            | 1   |
| 10KA01   | RELAIS INDUSTRIEL EMBROCHABLE, MONOSTABLE, 4INV, 24VAC + EMBASE                        | RMIA4524AC + ZMI4SA | CARLO GAVAZZI      | 1   |
| 10PF01   | RELAIS DE CONTROLE TRIPHASÉ POUR L'ORDRE ET LA PERTE DE PHASES, 208-480VAC, 1INV       | DPA51CM44           | CARLO GAVAZZI      | 1   |
| 10QD01   | DISJONCTEUR IC60N 3P 1A, 440VAC/25kA, 133VDC/6kA, COURBE C                             | A9F74301            | SCHNEIDER ELECTRIC | 1   |
| 10QD02   | DISJONCTEUR IC60N 2P 2A, 440VAC/25kA, 133VDC/6kA, COURBE C                             | A9F74202            | SCHNEIDER ELECTRIC | 1   |
| 10QD03   | DISJONCTEUR DT40 1P+N 4A 6kA, COURBE C   | A9N21022            | SCHNEIDER ELECTRIC | 1   |
| 10QDG01  | DISJONCTEUR DE BRANCHEMENT DIFFERENTIEL, 4P, 400VAC, 10/15/20/25/30A, 500mA INSTANTANE | 401010              | LEGRAND            | 1   |
| 10QIG01  | INTERRUPTEUR DIFFERENTIEL IID TYPE AC 415VAC 4P 40A 300mA                              | A9R14440            | SCHNEIDER ELECTRIC | 1   |
| 10TR01   | TRANSFORMATEUR DE COMMANDE ET DE SIGNALISATION MONOPHASEE 230-400V/24-48V, 100VA       | 044233              | LEGRAND            | 1   |
| 12ECH01  | RESISTANCE CHAUFFANTE PTC CS 060, 120-240V AC/DC, 50W                                  | 06000.0-00          | STEGO              | 1   |
| 12KTH01  | PETIT THERMOSTAT KTO 011, 1NF, 0..60°C   | 01146.9-00          | STEGO              | 1   |
| 12QD01   | DISJONCTEUR DT40 VIGI 1P+N CLASSE AC 16A 30mA COURBE C                                 | A9N21444            | SCHNEIDER ELECTRIC | 1   |
| 12QD02   | DISJONCTEUR DT40 1P+N 1A 6kA, COURBE C   | A9N21019            | SCHNEIDER ELECTRIC | 1   |
| 12X01    | PRISE DE COURANT 2P+T 10/16A, 250VAC A ECLIPS  | 004280              | LEGRAND            | 1   |
| 15PA01   | AMPEREMETRE ROTEX R72A90-A, 0-10A-50A DIRECT DEV. 90D                                  | 192D1301            | SOCOMEK            | 1   |
|          | 2 CAPUCHONS  | 192Z1016            | SOCOMEK            | 1   |
| 15PA02   | AMPEREMETRE ROTEX R72A90-A, 0-10A-50A DIRECT DEV. 90D                                  | 192D1301            | SOCOMEK            | 1   |
|          | 2 CAPUCHONS  | 192Z1016            | SOCOMEK            | 1   |
| 15QD01   | DISJONCTEUR MOTEUR MAGNETO-THERMIQUE 4-6.3A, BORNES A VIS                              | GV2ME10             | SCHNEIDER ELECTRIC | 1   |
|          | ADDITIF FRONTAL F+O  | GVAE11              | SCHNEIDER ELECTRIC | 1   |
| 15QD02   | DISJONCTEUR MOTEUR MAGNETO-THERMIQUE 4-6.3A, BORNES A VIS                              | GV2ME10             | SCHNEIDER ELECTRIC | 1   |
|          | ADDITIF FRONTAL F+O  | GVAE11              | SCHNEIDER ELECTRIC | 1   |
| 20E01    | RACK S530 5 EMBLEMENTS AVEC ALIM SECTEUR 230VAC  | T9930A100           | SOFREL             | 1   |
| 20E01-01 | MODULE DE COMMUNICATION PSTN (RTC) 33.600 bps  | V5900510            | SOFREL             | 1   |
| 20E01-02 | MODULE D'ENTREES, 8E TOR   | V5900210            | SOFREL             | 1   |
| 20FP01   | PROTECTION SECTEUR 230V, 5kA, Up=1.2kV   | T5300011            | SOFREL             | 1   |
| 20FP02   | PROTECTION RTC   | T5300012            | SOFREL             | 1   |
| 20G01    | BATTERIE 12V, 7Ah  | NP7-12FR            | YUASA              | 1   |
| 20QD01   | DISJONCTEUR DT40 1P+N 4A 6kA, COURBE C   | A9N21022            | SCHNEIDER ELECTRIC | 1   |
| 20X01    | PRISE TELEPHONIQUE SAILLIE - 8 CONTACTS  | 051219              | LEGRAND            | 1   |
| 22S01    | TETE BOUTON TOURNANT 2 POSITIONS A SERRURE AVEC CLE N°455                              | ZB4BG2              | SCHNEIDER ELECTRIC | 1   |
|          | CORPS CONTACT NO   | ZB4BZ101            | SCHNEIDER ELECTRIC | 1   |
| 22S02    | INTERRUPTEUR DE POSITION 1NO+1NF RB, M12 POUSSOIR A GALET, 1m CABLE                    | XCMD21F2L1          | SCHNEIDER ELECTRIC | 1   |
| 30KA01   | RELAIS INDUSTRIEL EMBROCHABLE, MONOSTABLE, 4INV, 24VAC + EMBASE                        | RMIA4524AC + ZMI4SA | CARLO GAVAZZI      | 1   |
| 30KA02   | RELAIS INDUSTRIEL EMBROCHABLE, MONOSTABLE, 4INV, 24VAC + EMBASE                        | RMIA4524AC + ZMI4SA | CARLO GAVAZZI      | 1   |
| 30KA03   | RELAIS INDUSTRIEL EMBROCHABLE, MONOSTABLE, 4INV, 24VAC + EMBASE                        | RMIA4524AC + ZMI4SA | CARLO GAVAZZI      | 1   |
| 30KA04   | RELAIS INDUSTRIEL EMBROCHABLE, MONOSTABLE, 4INV, 24VAC + EMBASE                        | RMIA4524AC + ZMI4SA | CARLO GAVAZZI      | 1   |



3, Rue Pierre Curie  
91230 MONTGERON  
Tél. : 01.69.52.47.00 - Fax : 01.69.52.47.01  
e-mail : seguin@automatismes-seguin.fr  
http://www.automatismes-seguin.fr

**NOMENCLATURE**

|  |        |             |                                 |
|--|--------|-------------|---------------------------------|
| CLIENT ET NOM DU DOSSIER / CUSTOMER AND NAME OF FOLDER |        |             | INDICE / REVIEW                 |
| SAUR   |        |             | 0                               |
| Armoire PR Bichereau - THOURY FEROTTES                 |        |             |                                 |
| DESSINATEUR<br>DRAWER                                  | K.C.   | FOLIO/SHEET | 50 / 51                         |
| N° AFFAIRE<br>N° PROJECT                               | 170039 |             |                                 |
|  |        |             | IGE-XAO<br>VARI SERVICE PACK 7A |

