

05/12/2018	0	A.C.	RETOUR ESSAIS	F.C.	R.M.
24/10/2018	B	F.CO.	MISE A JOUR	F.C.	R.M.
21/09/2018	A	M.H.	PREMIERE EMISSION	F.C.	R.M.
DATE	REV.	DESSINE PAR	MODIFICATIONS	VERIFIE PAR	APPROUVE PAR
DATE	REV.	DRAWN BY	REVISIONS	CHECKED BY	APPROVED BY

SCHEMA ELECTRIQUE ELECTRICAL DRAWING



3, Rue Pierre Curie
91230 MONTGERON
Tél. : 01.69.52.47.00 - Fax : 01.69.52.47.01
e-mail : seguin@automatismes-seguin.fr
<http://www.automatismes-seguin.fr>

PLAN: 180319	REV: 0
CDE: 18108044YP00900	

Ce document est notre propriété. Il ne peut être reproduit et / ou communiqué sans autorisation.
This document is our property. It cannot be reproduced and / or transmitted without authorization.



Armoire De Supression HER Y

LETTRE DE REPERAGE DES ELEMENTS DU SCHEMA

QI	INTERRUPTEUR	PCPI	CONTROLEUR D'ISOLEMENT	KT	RELAIS TEMPORISE	SA	COMMUTATEUR D'AMPEREMETRE
QIG	INTERRUPTEUR GENERAL	TR	TRANSFORMATEUR DE TENSION	KAU	RELAIS ARRET D'URGENCE	SV	COMMUTATEUR DE VOLTMETRE
QD	DISJONCTEUR	TC	TRANSFORMATEUR DE COURANT	UF	VARIATEUR	ECH	RESISTANCE CHAUFFANTE
QDG	DISJONCTEUR GENERAL	U	ONDULEUR, ALIMENTATION	UM	DEMARREUR	ECL	ECLAIRAGE
FP	PARAFONDRE	KIC	INTER CREPUSCULAIRE	S	ORGANE DE COMMANDE	G	BATTERIE
FU	FUSIBLE	KIH	HORLOGE	H	VOYANT, SIRENE	P	INSTRUMENTATION
F	THERMIQUE	KTH	THERMOSTAT	PCH	COMPTEUR HORAIRE	X	PRISE DE COURANT, BORNIER
QF	SECTIONNEUR FUSIBLE	KM	CONTACTEUR	PA	AMPEREMETRE	E	MATERIELS AUTRES
PF	CONTROLEUR DE PHASE	KA	RELAIS	PV	VOLTMETRE	KTL	TELERUPTEUR

LETTER CODES FOR ITEMS DESIGNATION ON THE DRAWING

QI	SWITCH	PCPI	INSULATION CONTROLLER	KT	TEMPORIZES RELAY	SA	AMPEREMETER SWITCH
QIG	GENERAL SWITCH	TR	TENSION TRANSFORMER	KAU	EMERGENCY STOP RELAY	SV	VOLTMETER SWITCH
QD	BREAKER	TC	CURRENT TRANSFORMER	UF	VELOCITY VARIATOR	ECL	LIGHT
QDG	GENERAL BREAKER	U	INVERTER, SUPPLY	UM	MOTOR STARTER	ECH	HEATER
FP	LIGHTNING PROTECTOR	KIC	DIMMER	S	CONTROL UNIT	G	BATTERY
FU	FUSE	KIH	CLOCK	H	INDICATOR	P	INSTRUMENTATION
F	THERMAL RELAY	KTH	THERMOSTAT	PCH	TIMER	X	SOCKET, TERMINAL BLOCK
QF	DISCONNECTING SWITCH	KM	CONTACTOR	PA	AMPEREMETER	E	OTHER EQUIPMENTS
PF	PHASE CONTROLLER	KA	RELAY	PV	VOLTMETER	KTL	TELEBREAKER

COULEURS DE FILS

TRI 400V: <= 6 mm2 Noir Rouge Brun
> 6 mm2 Noir Bagué Noir Rouge Brun

NEUTRE: Bleu Clair

230VAC: Rouge avec Commun Bobines Blanc (*)

230VAC ONDULE: Neutre Bleu Clair Bagué Orange
Phase Noir Bagué Orange

110VAC: Noir avec Commun Bobines Blanc (*)

24VAC: Violet avec Commun Bobines Blanc (*)

24VDC: Bleu Foncé avec Commun Bobines Blanc (*)

48VAC: Violet avec Commun Bobines Blanc (*)

48VDC: Bleu Foncé avec Commun Bobines Blanc (*)

REPORTS: Orange

TERRE: Vert/Jaune

ANALOGIQUE: Une Paire + Brun - Blanc
Unifilaire Blanc

TENSION EXTERNE PERMANENTE INTER GENERAL OUVERT: Orange

ATTENTION

Si plusieurs tensions de télécommande, alors prendre uniquement le 230VAC avec Commun Bobines Blanc

(*) Si Télécommande

WIRE COLOR

TRI 400V: <= 6 mm2 Black Red Brown
> 6 mm2 Black with Ring Black Red Brown

NEUTRE: Light Blue

230VAC: Red with Spods Common White (*)

230VAC UPS: Neutre Light Blue with Ring Orange
Phase Black with Ring Orange

110VAC: Black with Spods Common White (*)

24VAC: Purple with Spods Common White (*)

24VDC: Dark Bleu with Spods Common White (*)

48VAC: Purple with Spods Common White (*)

48VDC: Dark Bleu with Spods Common White (*)

REPORTS: Orange

GROUND: Green/Yellow

ANALOGICAL: One Pair + Brown - White
Unifilar White

PERMANENTLY EXTERNAL POWER GENERAL BREAKER OPEN: Orange

CAUTION

If There are Several Tensions of Command Then to take Only the 230VAC with Spods Common White

(*) If Command

TYPE DE RELAIS ET DE CONTACT DANS LE SCHEMA



RELAY AND CONTACT TYPE IN THE DRAWING

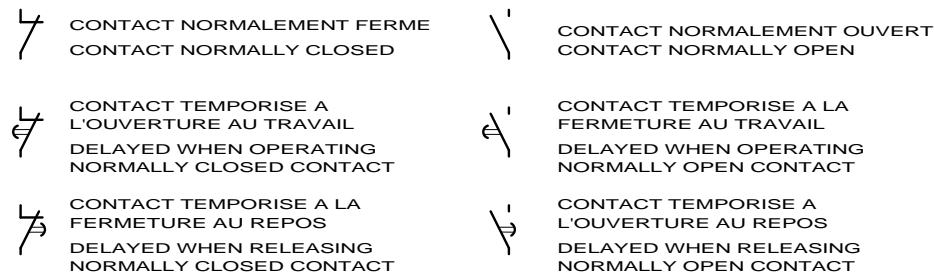

LE SCHEMA EST REPRESENTE HORS TENSION ET GENERATEUR HORS SERVICE

THE DRAWING IS SHOWN OUT OF VOLTAGE AND WITH GENERATOR OUT OF SERVICE



3, Rue Pierre Curie
91230 MONTGERON
Tél. : 01.69.52.47.00 - Fax : 01.69.52.47.01
e-mail : seguin@automatismes-seguin.fr
http://www.automatismes-seguin.fr

LEGENDE DU SCHEMA ELECTRIQUE

CLIENT ET NOM DU DOSSIER / CUSTOMER AND NAME OF FOLDER		INDICE / REVIEW
SAUR		0
Armoire De Supression HERY		IGE-XAO
DESSINATEUR / DRAWER	M.H.	FOLIO/SHEET 03/04
N° AFFAIRE / N° PROJECT	180319	VARZ SERVICE PACK 11 - (A.49.F)

CODE DU REPERAGE

LETTER CODE

1/ DES APPAREILS DANS LES ARMOIRES
APPARATUS IN THE CABINETS

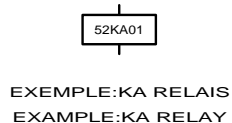

52 KA 01

N° D'ORDRE DANS LE FOLIO D'ORIGINE
ORDER NUMBER ON ORIGINAL SHEET

LETTRE DE REPERAGE
LETTER CODES FOR ITEM

N° DU FOLIO D'ORIGINE
ORIGINAL SHEET NUMBER

2/ DES FILS DE CABLAGE
WIRING

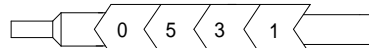

N° DU FOLIO D'ORIGINE
ORIGINAL SHEET NUMBER

N° DU FIL DANS LE FOLIO D'ORIGINE
NUMBER OF THE WIRE ON ORIGINAL SHEET

3/ REPORT DES CONTACTS DANS LE SCHEMA
CONTACT REPORT IN THE DRAWING



17.29

N° DE LA COLONNE OU EST UTILISE LE CONTACT
COLUMN NUMBER WHERE THE CONTACT IS USED

N° DU FOLIO OU EST UTILISE LE CONTACT
SHEET NUMBER WHERE THE CONTACT IS USED

4/ REPRESENTATION DES BORNES ET BORNIERES DANS LE SCHEMA
BINDINGS SCREWS VIEW IN THE DRAWING



N° D'ORDRE (SI NECESSAIRE)
ORDER NUMBER (IF NECESSARY)

NATURE DU BORNIER
NATURE OF TERMINAL BLOCK

- A : ALIMENTATION
- P : PUISSANCE
- T : TELECOMMANDE
- M : MESURE
- R : REPORTS



LE SCHEMA EST REPRESENTE HORS TENSION ET GENERATEUR HORS SERVICE

THE DRAWING IS SHOWN OUT OF VOLTAGE AND WITH GENERATOR OUT OF SERVICE



3, Rue Pierre Curie
91230 MONTGERON
Tél. : 01.69.52.47.00 - Fax : 01.69.52.47.01
e-mail : seguin@automatismes-seguin.fr
http://www.automatismes-seguin.fr

LEGENDE DU SCHEMA ELECTRIQUE

CLIENT ET NOM DU DOSSIER / CUSTOMER AND NAME OF FOLDER		INDICE / REVIEW
SAUR		0
Armoire De Supsression HERY		IGE-XAO
DESSINATEUR DRAWER	M.H.	FOLIO/SHEET 04/05
N° AFFAIRE N° PROJECT	180319	VARD SERVICE PACK 11-(14.49.F)

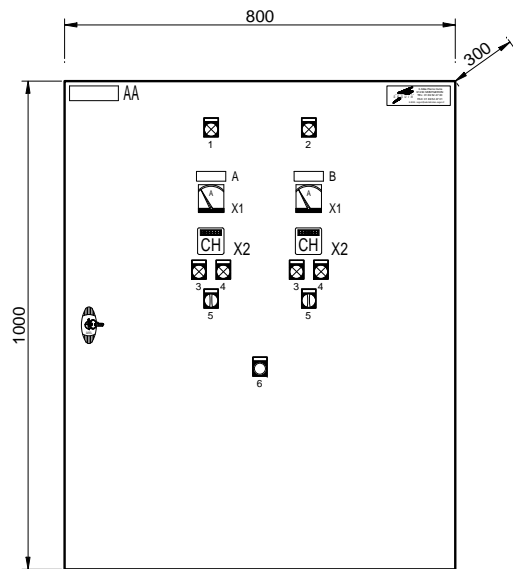

FACADE

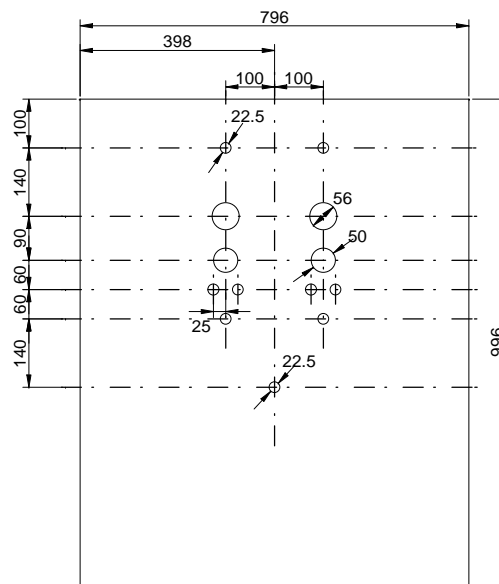

PLAN DE DECOUPE

ETIQUETTES 100x30

AA - SURPRESSION HERY

ETIQUETTES 60x20

A - POMPE 1
B - POMPE 2

ETIQUETTES SCHNEIDER

- 1 - SOUS TENSION
- 2 - MANQUE D'EAU
- 3 - MARCHE
- 4 - DEF AUT
- 5 - AUTO / 0 / MAIN
- 6 - REARMEMENT

DIVERS

- X1 - AMPEREMETRE
- X2 - COMPTEUR HORAIRE



3, Rue Pierre Curie
91230 MONTGERON
Tél. : 01.69.52.47.00 - Fax : 01.69.52.47.01
e-mail : seguin@automatismes-seguin.fr
http://www.automatismes-seguin.fr

IMPLANTATION EXTERNE

CLIENT ET NOM DU DOSSIER / CUSTOMER AND NAME OF FOLDER		INDICE / REVIEW
SAUR		0
Armoire De Supsression HERY		IGE-XAO
DESSINATEUR DRAWER	M.H.	FOLIO/SHEET 05 / 10
N° AFFAIRE N° PROJECT	180319	VARD SERVICE PACK.11-(4.49.F)

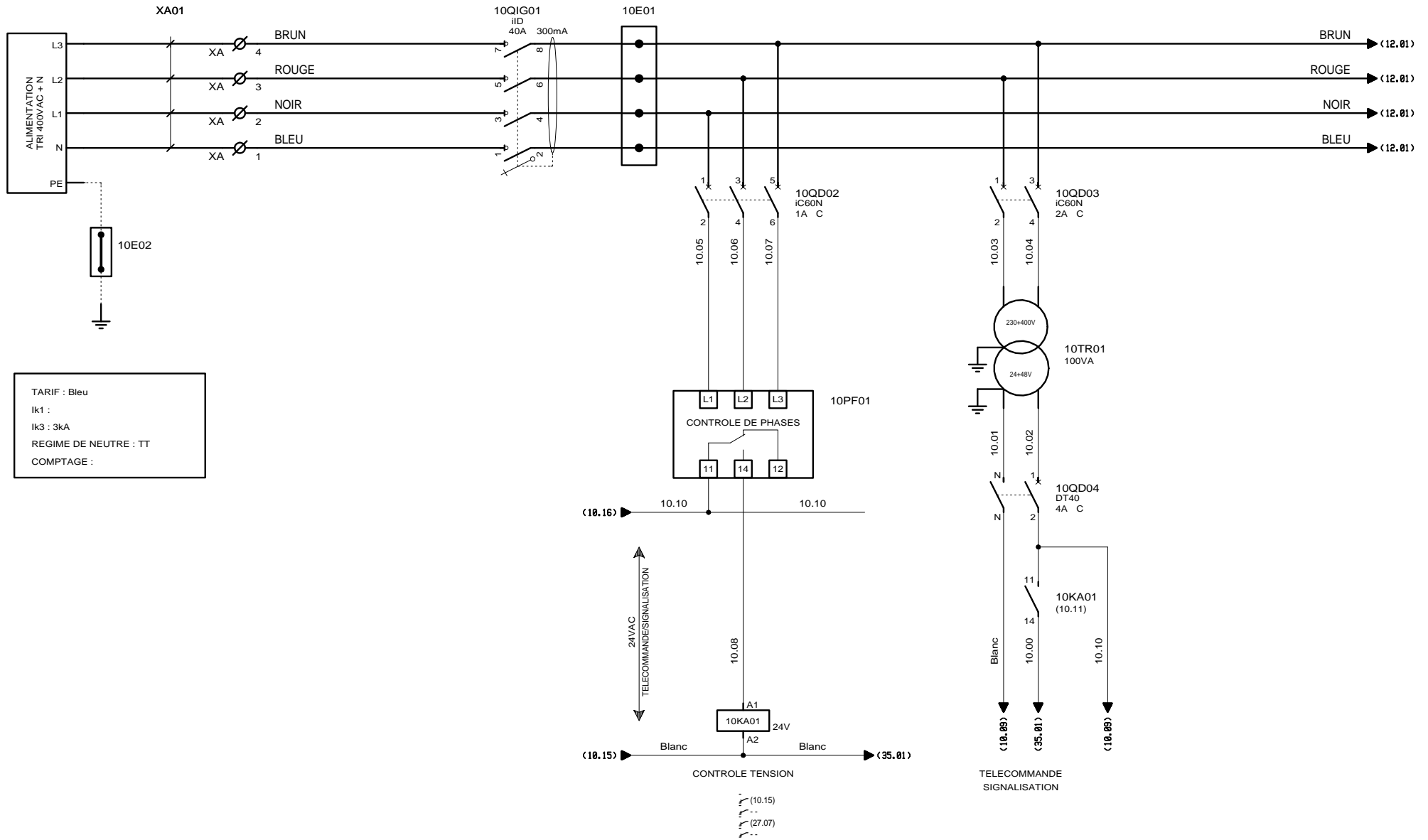

ARRIVEE GENERALE

CLIENT ET NOM DU DOSSIER / CUSTOMER AND NAME OF FOLDER		INDICE / REVIEW
SAUR		O
Armoire De Supsression HERY		
DESSINATEUR / DRAWER	M.H.	FOLIO/SHEET 10 / 12
N° AFFAIRE / N° PROJECT	180319	
VARZ SERVICE PACK.11-(4.49.F)		

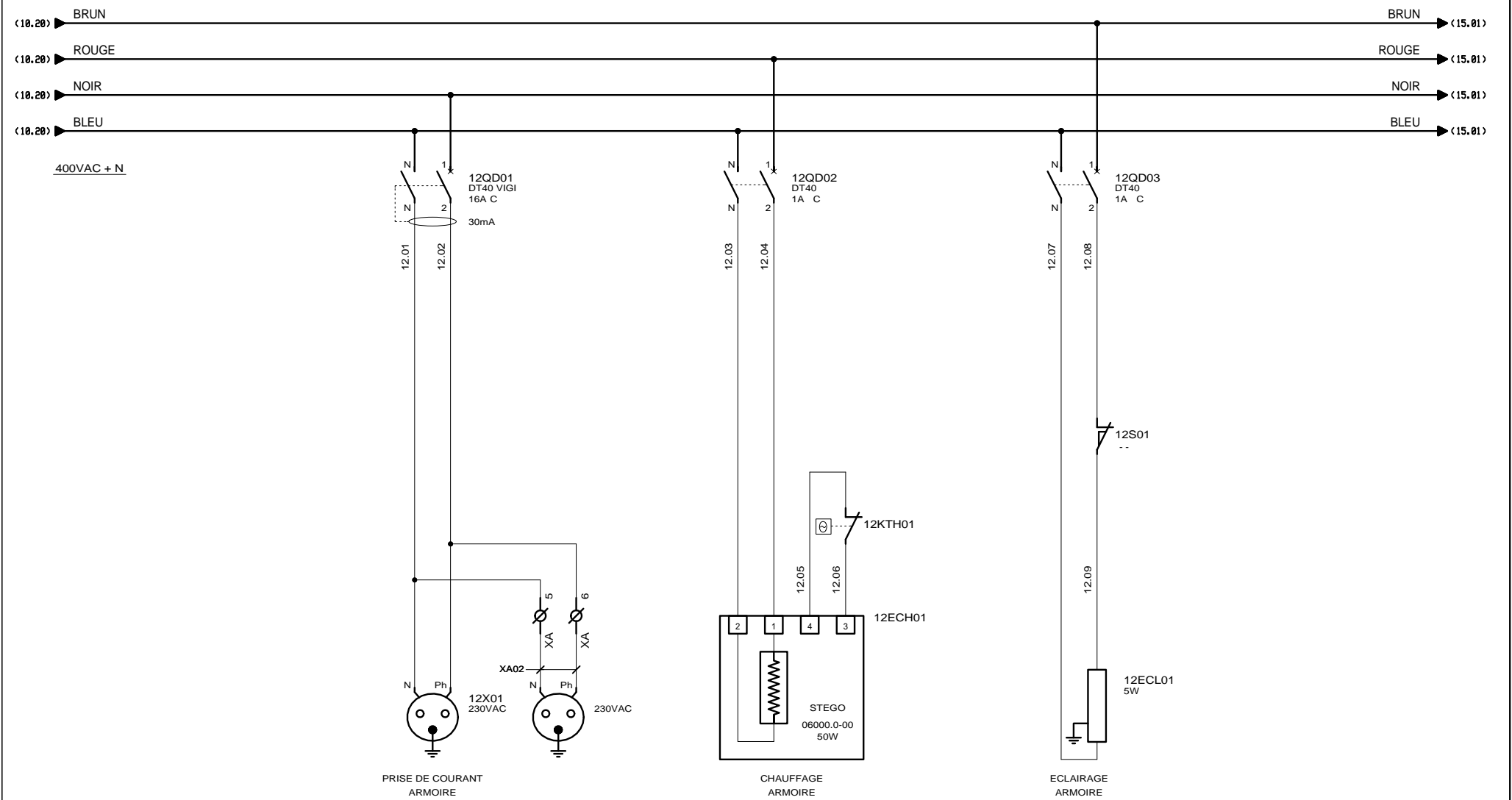

**DISTRIBUTION 400VAC + N
UTILITES**

CLIENT ET NOM DU DOSSIER / CUSTOMER AND NAME OF FOLDER		INDICE / REVIEW
SAUR		0
Armoire De Supsression HERY		IGE-XAO VARZ SERVICE PACK.11-(A.49.F)
DESSINATEUR DRAWER	M.H.	
N° AFFAIRE N° PROJECT	180319	
FOLIO/SHEET 12 / 15		

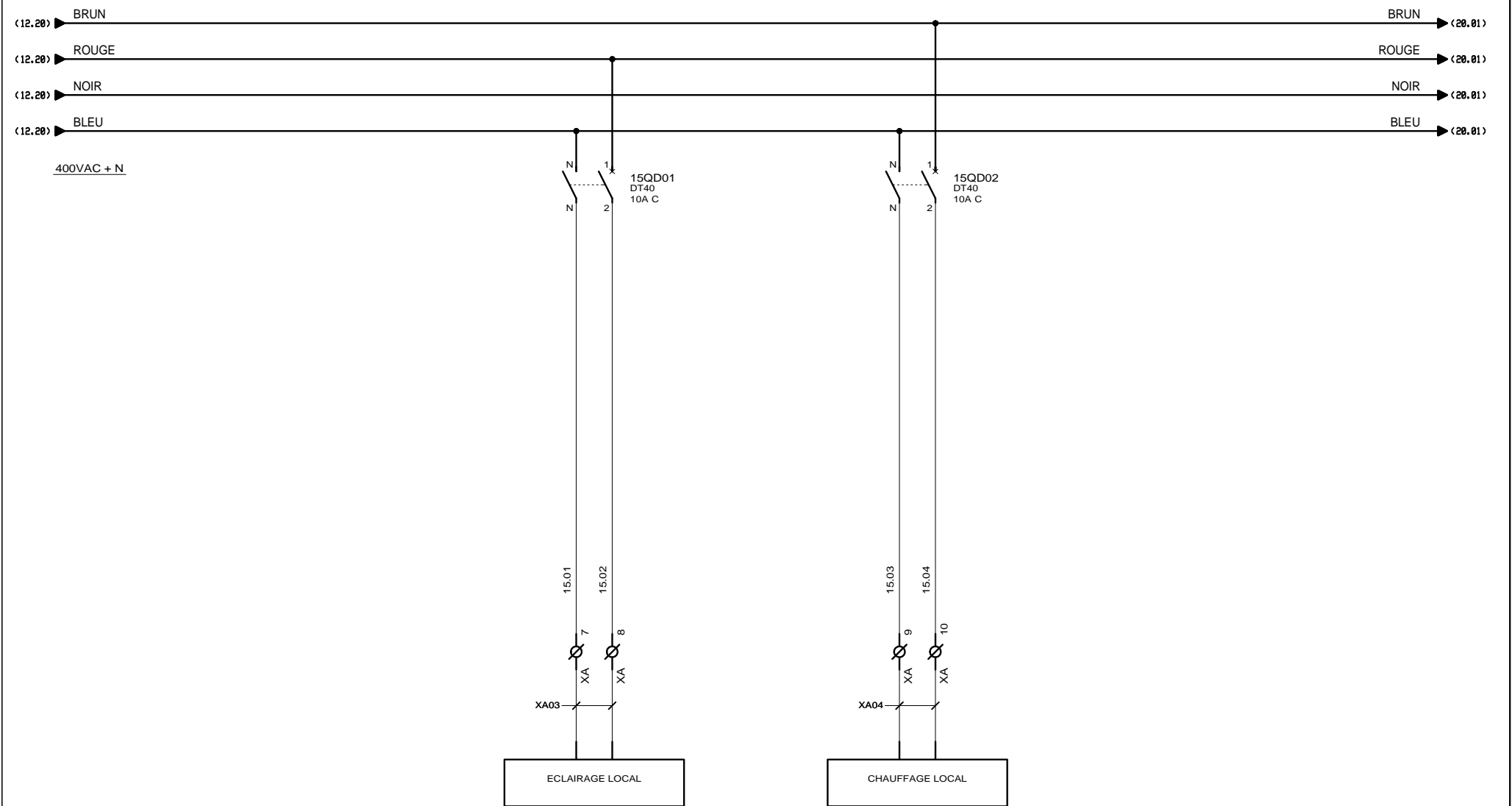



 3, Rue Pierre Curie
 91230 MONTGERON
 Tél. : 01.69.52.47.00 - Fax : 01.69.52.47.01
 e-mail : seguin@automatismes-seguin.fr
 http://www.automatismes-seguin.fr

DISTRIBUTION 400VAC + N ALIMENTATION LOCAL

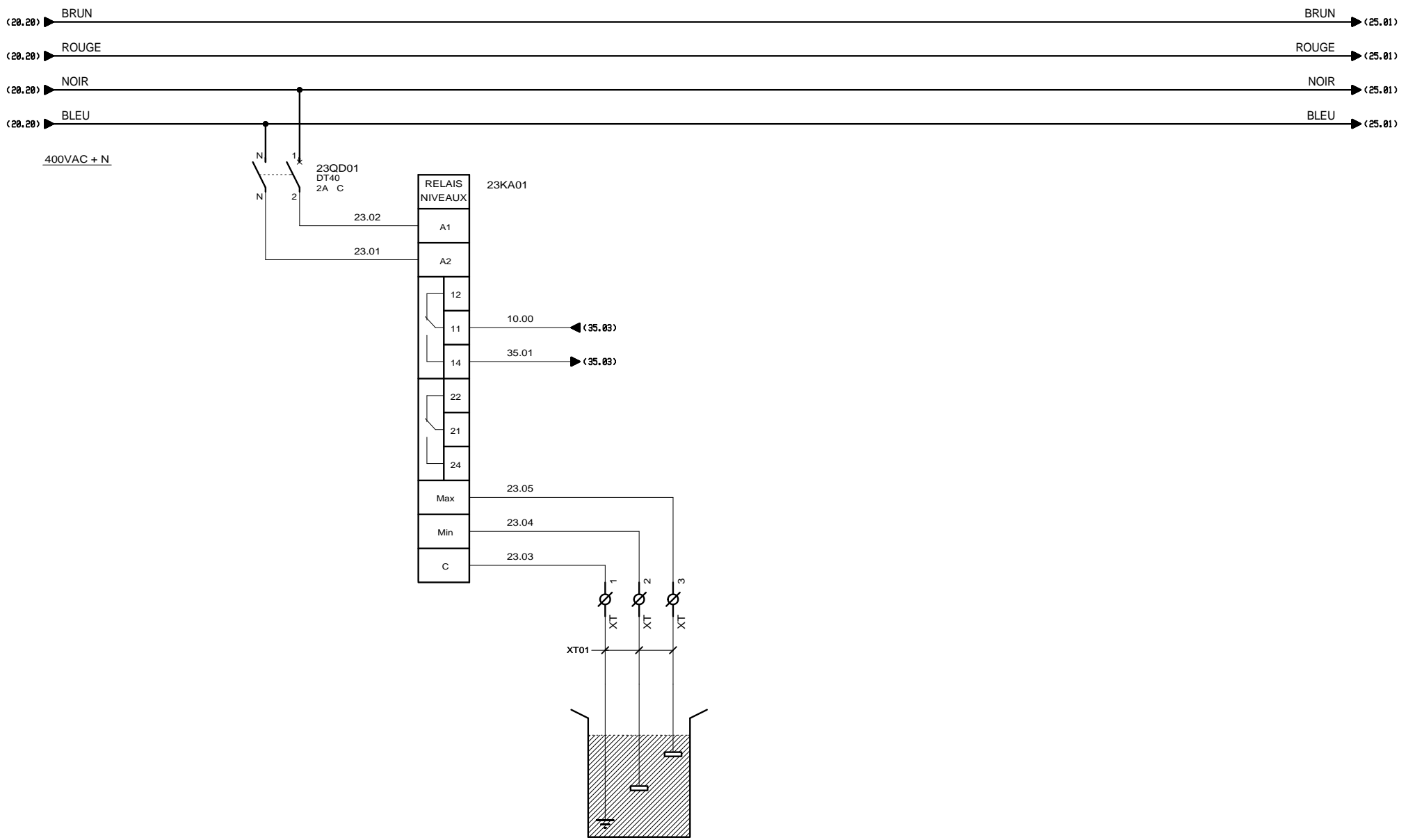
CLIENT ET NOM DU DOSSIER / CUSTOMER AND NAME OF FOLDER		INDICE / REVIEW
SAUR		0
Armoire De Supsression HERY		
DESSINATEUR DRAWER	M.H.	FOLIO/SHEET 15 / 20
N° AFFAIRE N° PROJECT	180319	
<small>IGE-XAO</small> <small>VARD SERVICE PACK 11-(4.49.F)</small>		



 3, Rue Pierre Curie
 91230 MONTGERON
 Tél. : 01.69.52.47.00 - Fax : 01.69.52.47.01
 e-mail : seguin@automatismes-seguin.fr
 http://www.automatismes-seguin.fr

MANQUE D'EAU

CLIENT ET NOM DU DOSSIER / CUSTOMER AND NAME OF FOLDER		INDICE / REVIEW
SAUR		0
Armoire De Supsression HERY		
DESSINATEUR / DRAWER	M.H.	FOLIO/SHEET 23 / 25
N° AFFAIRE / N° PROJECT	180319	<small>VARZ SERVICE PACK 11-14-19-FI</small>

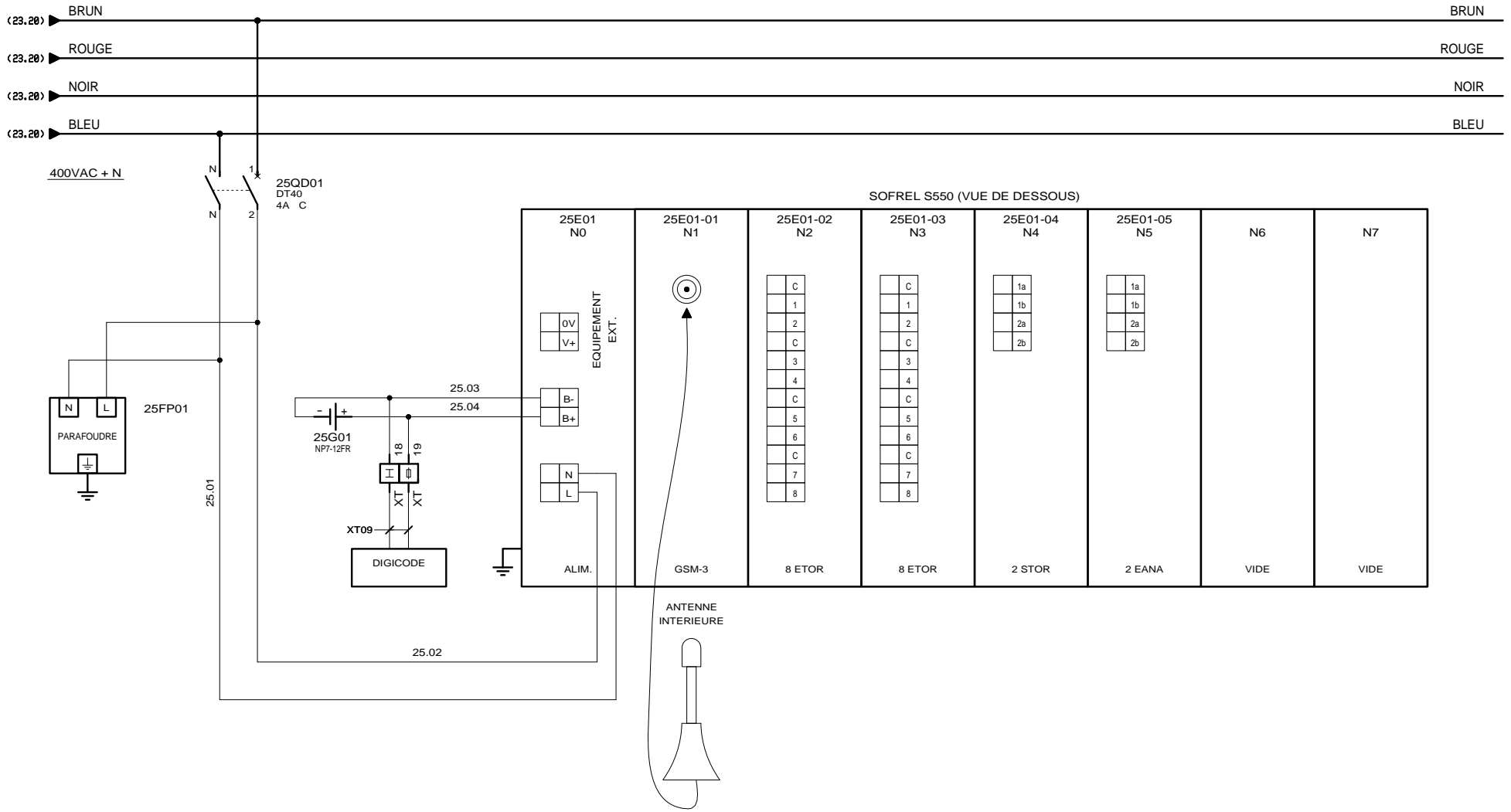

ALIMENTATION SOFREL S550

CLIENT ET NOM DU DOSSIER / CUSTOMER AND NAME OF FOLDER		INDICE / REVIEW
SAUR		0
Armoire De Supsression HERY		
DESSINATEUR / DRAWER	M.H.	FOLIO/SHEET 25 / 27
N° AFFAIRE / N° PROJECT	180319	
VARD SERVICE PACK 11-14-49-FI		

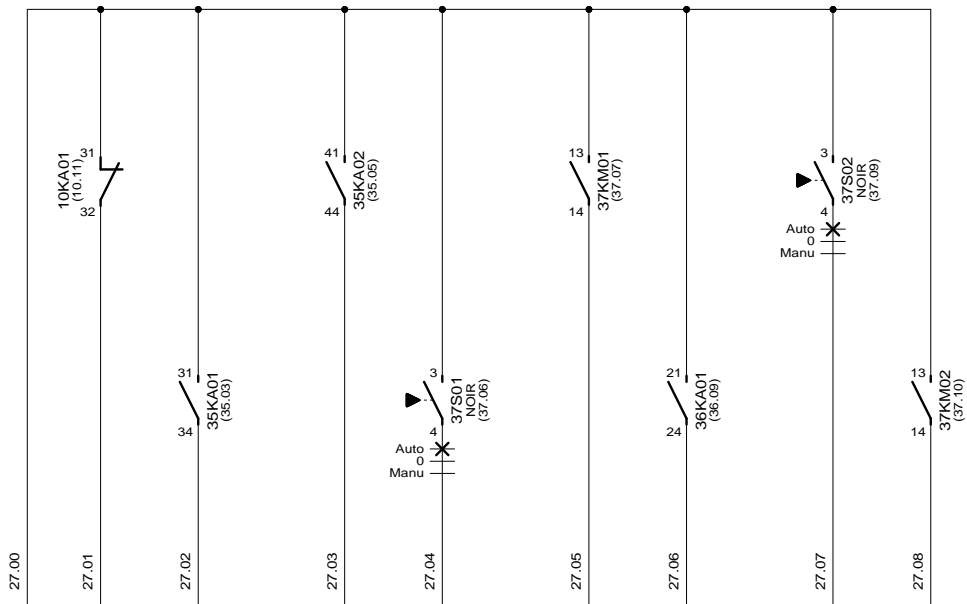

BORNIER	C	1	2	C	3	4	C	5	6	C	7	8
VOIES		1	2		3	4		5	6		7	8
DESIGNATION		(COMMUN VOIES 1 ET 2)	PRESENCE TENSION	MANQUE D'EAU	(COMMUN VOIES 3 ET 4)	PRESSON BASSE	AUTO POMPE 1 (COMMUN VOIES 5 ET 6)	RETOUR DE MARCHE POMPE 1	DEFAUT POMPE 1 (COMMUN VOIES 7 ET 8)	AUTO POMPE 2	RETOUR DE MARCHE POMPE 2	
CARTE 8 ETOR SOFREL S550												

25E01-02
(25.10)

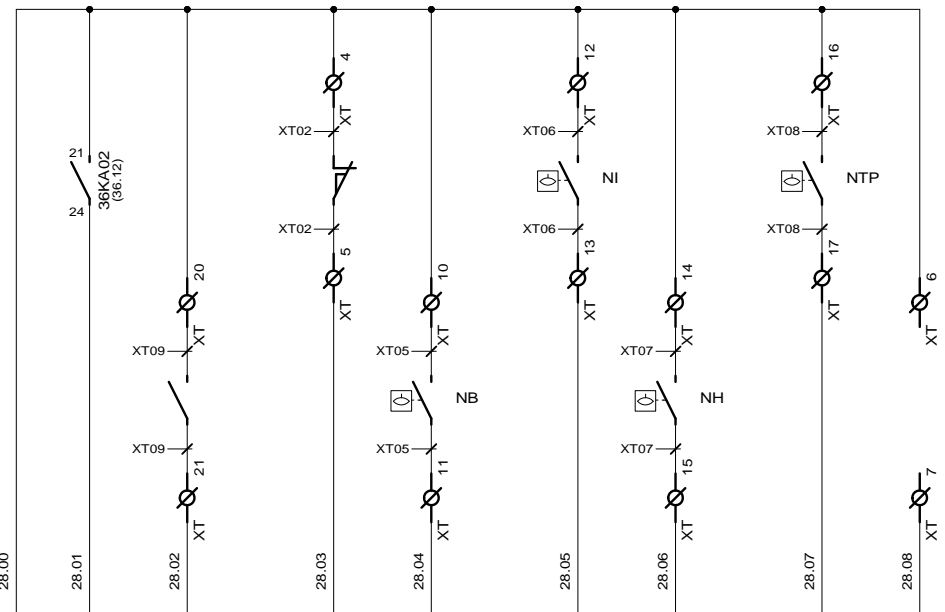

25E01-03
(25.11)

BORNIER	C	1	2	C	3	4	C	5	6	C	7	8
VOIES		1	2		3	4		5	6		7	8
DESIGNATION	(COMMUN VOIES 1 ET 2)	DEFAULT POMPE 2	DIGICODE	(COMMUN VOIES 3 ET 4)	INTRUSION	NIVEAU BAS	(COMMUN VOIES 5 ET 6)	NIVEAU INTERMEDIAIRE	NIVEAU HAUT	(COMMUN VOIES 7 ET 8)	NIVEAU TROP PLEIN	RESERVE SUR BORNES
CARTE 8 ETOR SOFREL S550												



3, Rue Pierre Curie
91230 MONTGERON
Tél. : 01.69.52.47.00 - Fax : 01.69.52.47.01
e-mail : seguin@automatismes-seguin.fr
http://www.automatismes-seguin.fr

CARTE 8 ENTrees TOR EMPLACEMENT 3

CLIENT ET NOM DU DOSSIER / CUSTOMER AND NAME OF FOLDER		INDICE / REVIEW
SAUR Armoire De SupleSSion HERY		0
DESSINATEUR DRAWER	M.H.	FOLIO/SHEET 28 / 29
N° AFFAIRE N° PROJECT	180319	
		IGE-XAO VARZ SERVICE PACK.11-(4.49.F)

CARTE 2 STOR SOFREL S550				
DESIGNATION	ARRET POMPAGE		REARMEMENT	
	1		2	
	1a	1b	2a	2b

25E01-04
(25.13)

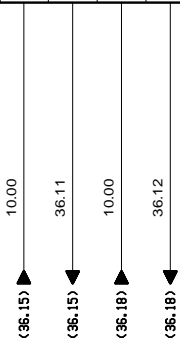

3, Rue Pierre Curie
91230 MONTGERON
Tél. : 01.69.52.47.00 - Fax : 01.69.52.47.01
e-mail : seguin@automatismes-seguin.fr
http://www.automatismes-seguin.fr

**CARTE 2 SORTIES TOR
EMPLACEMENT 4**

CLIENT ET NOM DU DOSSIER / CUSTOMER AND NAME OF FOLDER			INDICE / REVIEW
SAUR Armoire De Supsression HERY			0
DESSINATEUR DRAWER	M.H.	FOLIO/SHEET	29 / 30
N° AFFAIRE N° PROJECT	180319	IGE XAO VARZ SERVICE PACK.11-(A.49.F)	

RACCORDEMENT :
POUR CAPTEUR AUTONOME

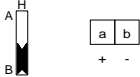

RACCORDEMENT :
POUR CAPTEUR TELEALIMENTE

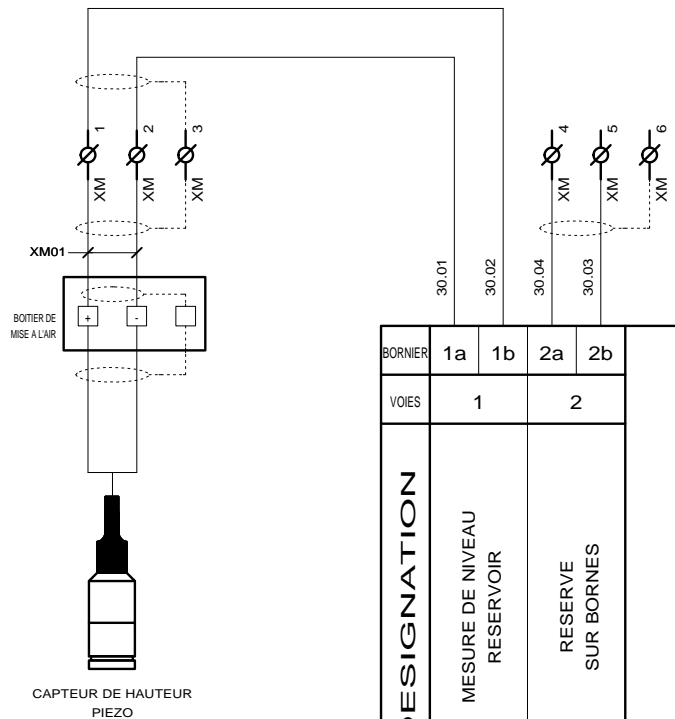
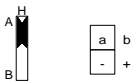

25E01-05
(25.14)

BORNIER	1a	1b	2a	2b
VOIES	1		2	
DESIGNATION	MESURE DE NIVEAU RESERVOIR		RESERVE SUR BORNES	
CARTE 2 EANA SOFREL S550				



3, Rue Pierre Curie
91230 MONTGERON
Tél. : 01.69.52.47.00 - Fax : 01.69.52.47.01
e-mail : seguin@automatismes-seguin.fr
<http://www.automatismes-seguin.fr>

CARTE 2 ENTREES ANALOGIQUES EMPLACEMENT 5

CLIENT ET NOM DU DOSSIER / CUSTOMER AND NAME OF FOLDER			INDICE / REVIEW
SAUR Armoire De Supsression HERY			0
DESSINATEUR DRAWER	M.H.	FOLIO/SHEET	30 / 35
N° AFFAIRE N° PROJECT	180319		
			 <small>VARD SERVICE PACK.11-(4.49.F)</small>

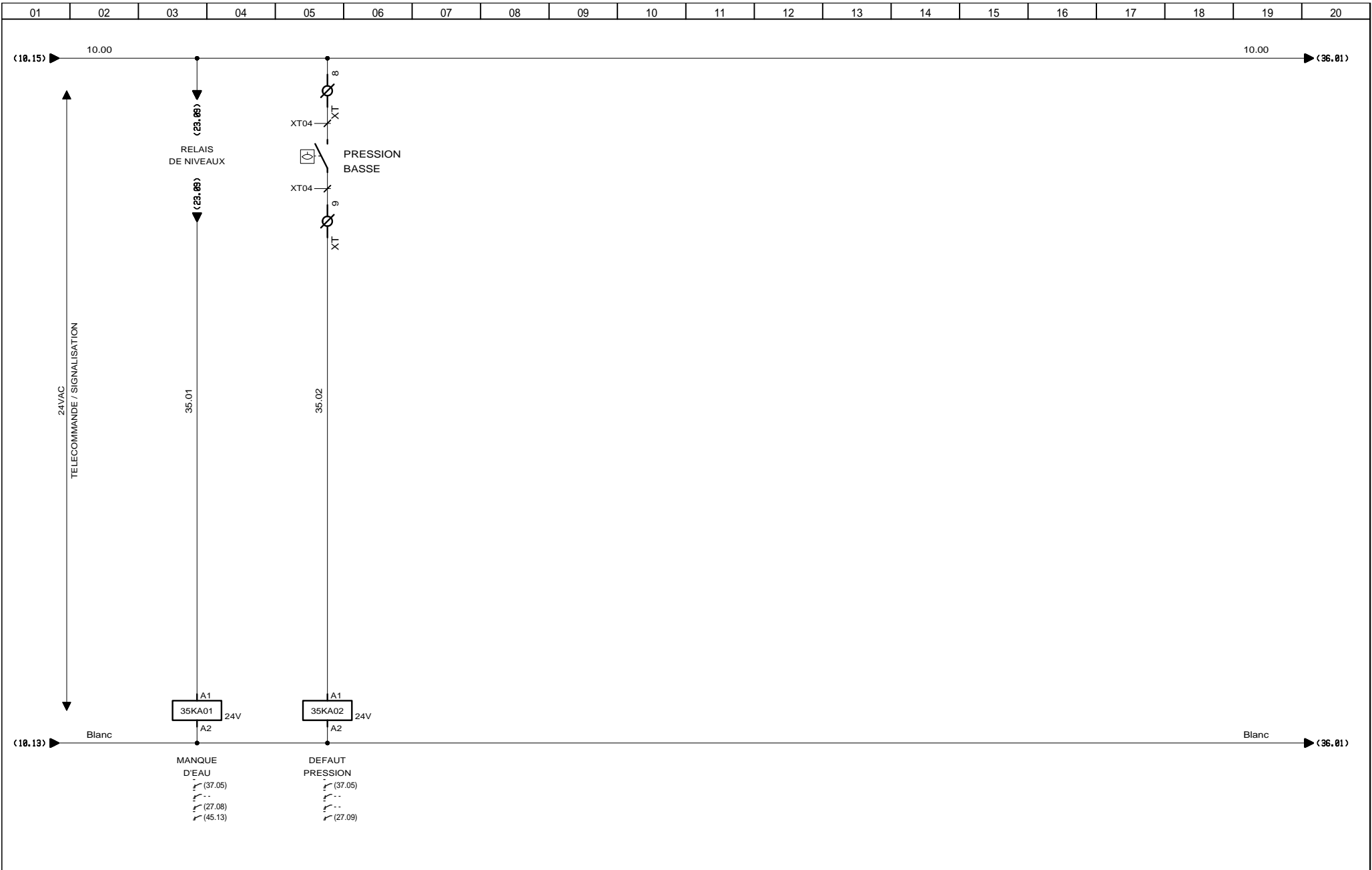

 3, Rue Pierre Curie
 91230 MONTGERON
 Tél. : 01.69.52.47.00 - Fax : 01.69.52.47.01
 e-mail : seguin@automatismes-seguin.fr
 http://www.automatismes-seguin.fr

RELAYAGE NIVEAUX

CLIENT ET NOM DU DOSSIER / CUSTOMER AND NAME OF FOLDER		INDICE / REVIEW
SAUR		O
Armoire De Suplecion HERY		
DESSINATEUR / DRAWER	M.H.	FOLIO/SHEET 35 / 36
N° AFFAIRE / N° PROJECT	180319	VARD SERVICE PACK.11-(4.49.F)

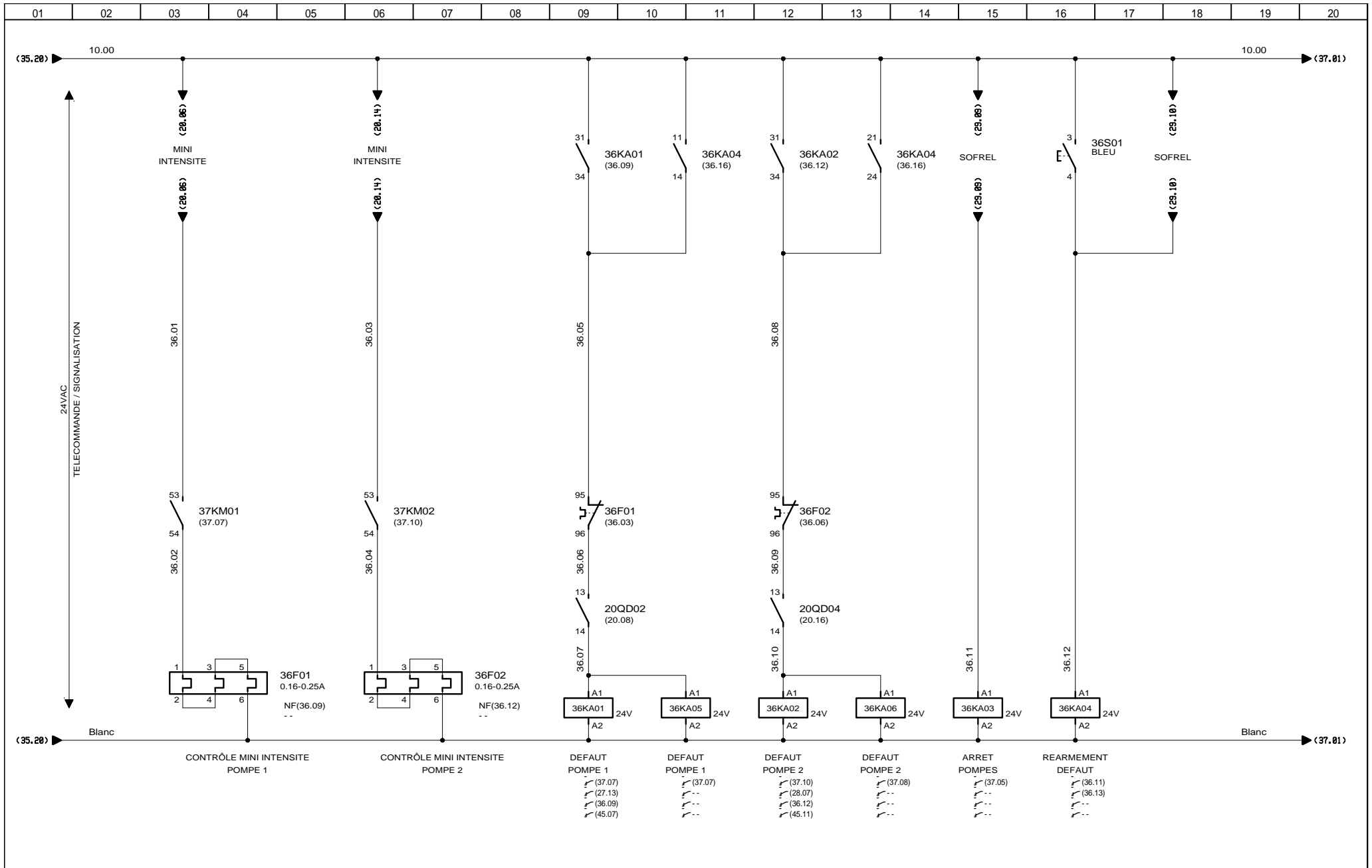

3, Rue Pierre Curie
91230 MONTGERON
Tél. : 01.69.52.47.00 - Fax : 01.69.52.47.01
e-mail : seguin@automatismes-seguin.fr
http://www.automatismes-seguin.fr

RELAYAGE DEFAUTS POMPES

CLIENT ET NOM DU DOSSIER / CUSTOMER AND NAME OF FOLDER		INDICE / REVIEW
SAUR		0
Armoire De Supression HERY		
DESSINATEUR DRAWER	M.H.	IGE XAO
N° AFFAIRE N° PROJECT	180319	FOLIO/SHEET 36 / 37
		VARZ SERVICE PACK.11-(A.49.F)

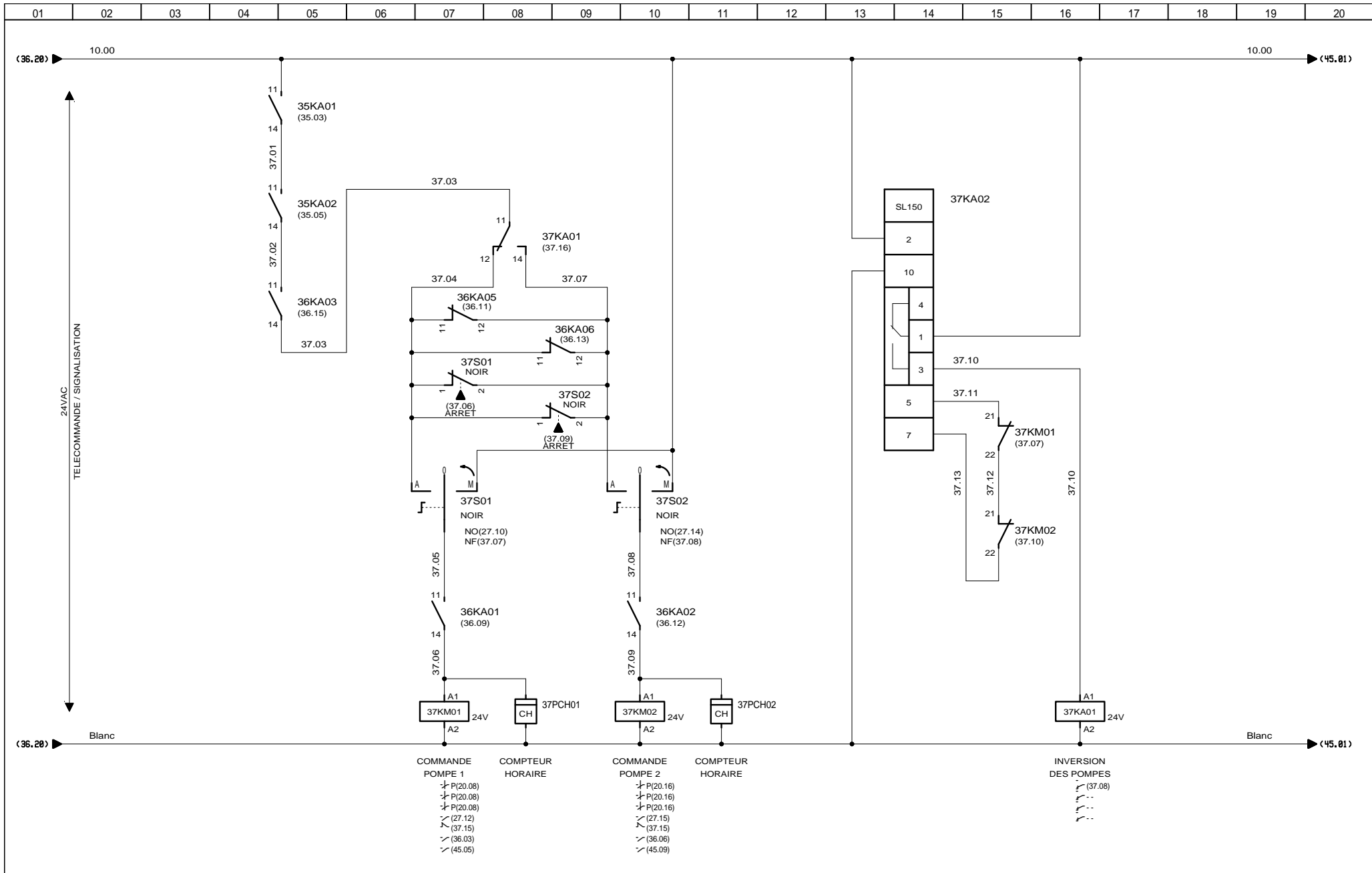

3, Rue Pierre Curie
91230 MONTGERON
Tél. : 01.69.52.47.00 - Fax : 01.69.52.47.01
e-mail : seguin@automatismes-seguin.fr
http://www.automatismes-seguin.fr

TELECOMMANDE POMPES

CLIENT ET NOM DU DOSSIER / CUSTOMER AND NAME OF FOLDER

SAUR

Armoire De Supression HERY

DESSINATEUR
DRAWER

M.H.

N° AFFAIRE
N° PROJECT

180319

FOLIO/SHEET

37 / 45

INDICE / REVIEW

0

IGE XAO
VARZ SERVICE PACK.11-(4.49.F)

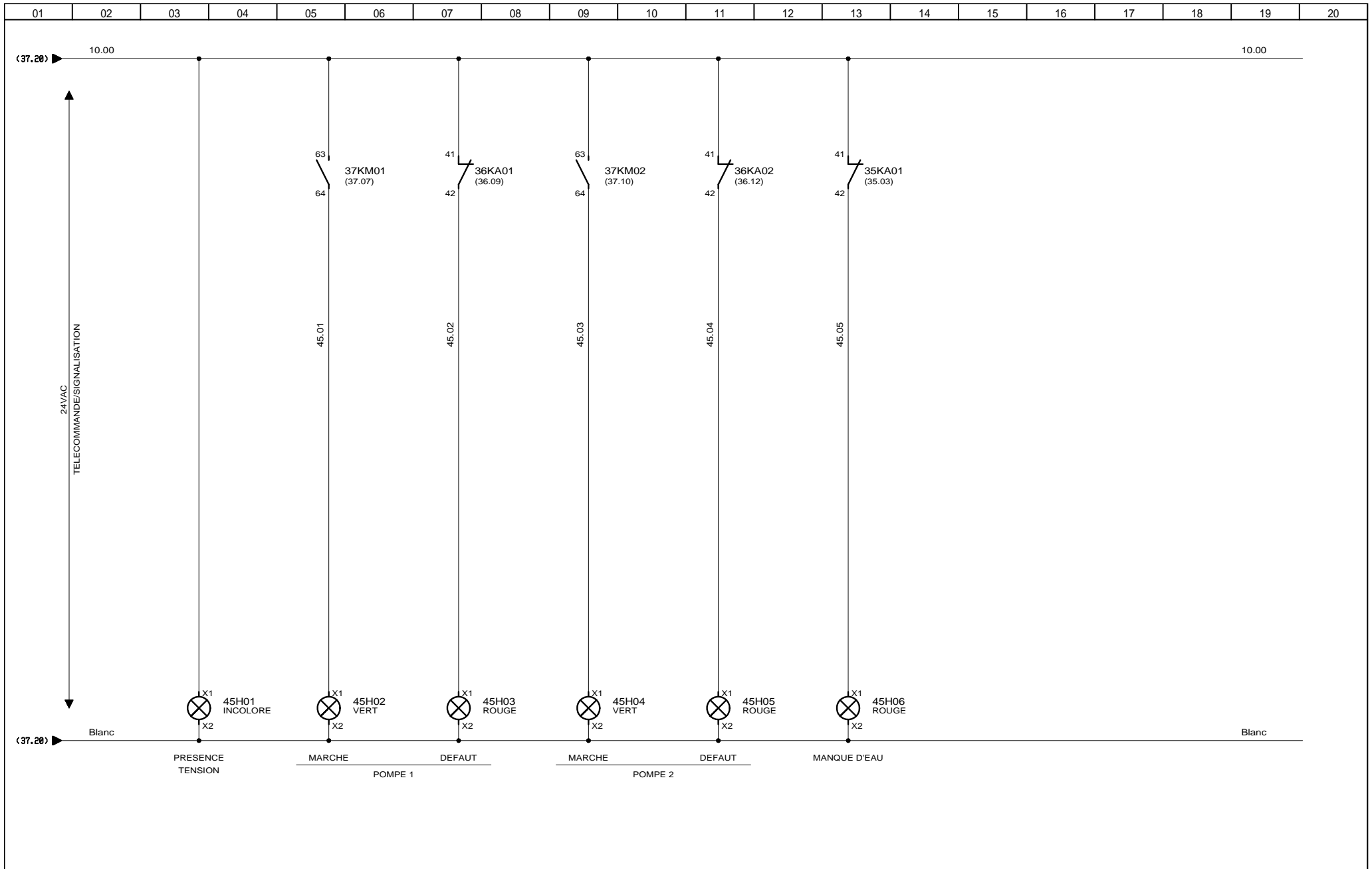

3, Rue Pierre Curie
 91230 MONTGERON
 Tél. : 01.69.52.47.00 - Fax : 01.69.52.47.01
 e-mail : seguin@automatismes-seguin.fr
<http://www.automatismes-seguin.fr>

SIGNALISATION

CLIENT ET NOM DU DOSSIER / CUSTOMER AND NAME OF FOLDER		INDICE / REVIEW
SAUR		0
Armoire De Supsression HERY		IGE-XAO
DESSINATEUR DRAWER	M.H.	FOLIO/SHEET 45 / 50
N° AFFAIRE N° PROJECT	180319	VARZ SERVICE PACK.11-(A.49.F)

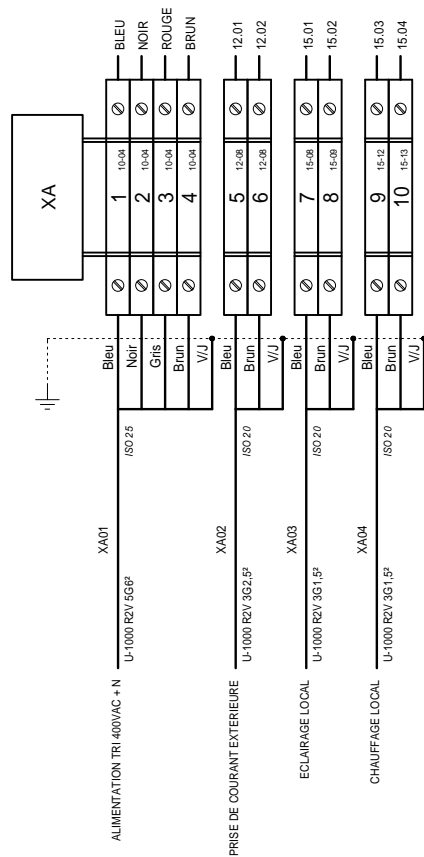

BORNIER XA ALIMENTATION

CLIENT ET NOM DU DOSSIER / CUSTOMER AND NAME OF FOLDER		INDICE / REVIEW
SAUR		0
Armoire De Supsression HERY		
DESSINATEUR DRAWER	M.H.	FOLIO/SHEET 50 / 51
N° AFFAIRE N° PROJECT	180319	
		 <small>VARZ SERVICE PACK.11-(A.49.F)</small>

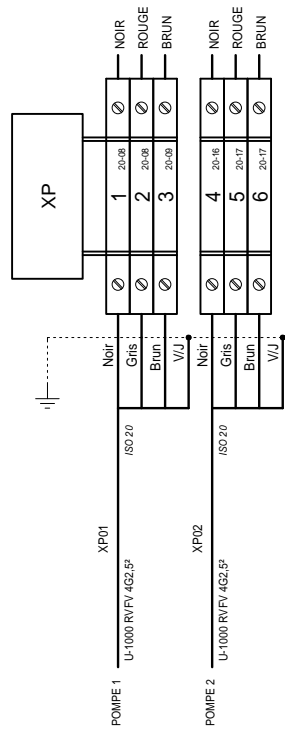

3, Rue Pierre Curie
91230 MONTGERON
Tél. : 01.69.52.47.00 - Fax : 01.69.52.47.01
e-mail : seguin@automatismes-seguin.fr
http://www.automatismes-seguin.fr

BORNIER XP PUISSANCE

CLIENT ET NOM DU DOSSIER / CUSTOMER AND NAME OF FOLDER		INDICE / REVIEW
SAUR Armoire De Supsression HERY		0
DESSINATEUR DRAWER	M.H.	FOLIO/SHEET 51 / 52
N° AFFAIRE N° PROJECT	180319	
		IGE XAO VARZ SERVICE PACK.11-(4.49.F)

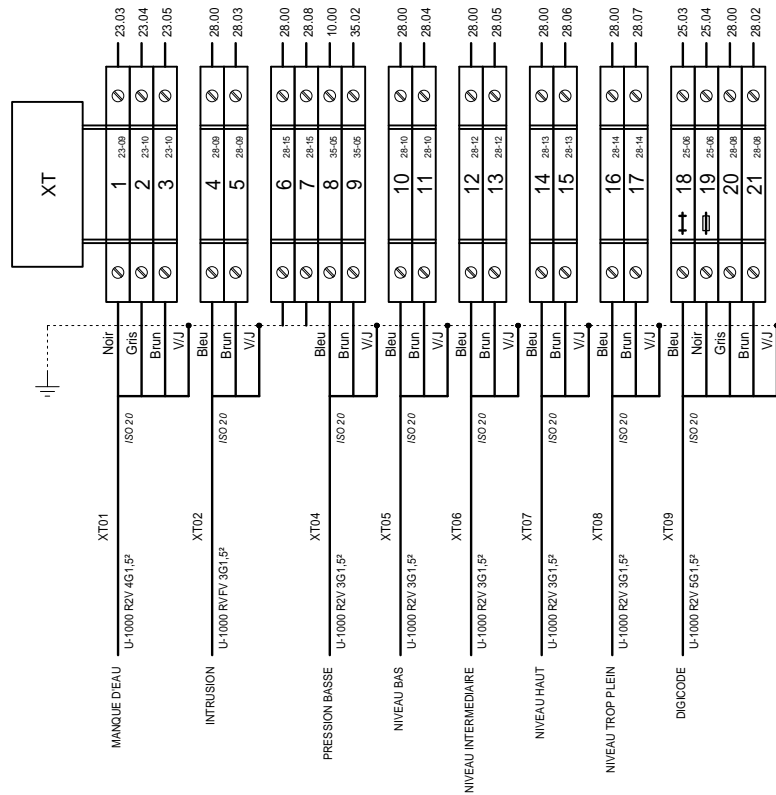

3, Rue Pierre Curie
91230 MONTGERON
Tél. : 01.69.52.47.00 - Fax : 01.69.52.47.01
e-mail : seguin@automatismes-seguin.fr
http://www.automatismes-seguin.fr

BORNIER XT TELECOMMANDE

CLIENT ET NOM DU DOSSIER / CUSTOMER AND NAME OF FOLDER		INDICE / REVIEW
SAUR		0
Armoire De Supsression HERY		
DESSINATEUR DRAWER	M.H.	IGE XAO
N° AFFAIRE N° PROJECT	180319	FOLIO/SHEET 52 / 53
		VARZ SERVICE PACK.11-(A.49.F)

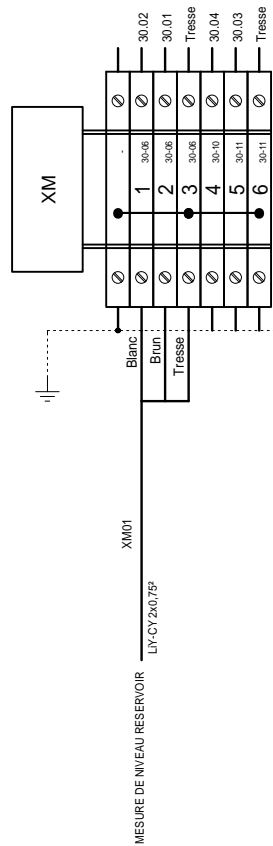

3, Rue Pierre Curie
 91230 MONTGERON
 Tél. : 01.69.52.47.00 - Fax : 01.69.52.47.01
 e-mail : seguin@automatismes-seguin.fr
 http://www.automatismes-seguin.fr

BORNIER XM MESURE

CLIENT ET NOM DU DOSSIER / CUSTOMER AND NAME OF FOLDER		INDICE / REVIEW
SAUR Armoire De Supsression HERY		0
DESSINATEUR DRAWER	M.H.	FOLIO/SHEET 53 / 60
N° AFFAIRE N° PROJECT	180319	
		IGE XAO VARZ SERVICE PACK.11-(4.49.F)

REPERE	DESIGNATION	REFERENCE	MARQUE	QTE
TOLERIE	COFFRET UNIVERSEL AVEC PORTE PLEINE SANS CHASSIS 1000x800x300, IP66, RAL7035	NSYS3D10830	SCHNEIDER ELECTRIC	1
	POIGNEE A CLE 1242E	NSYAEDL1242S3D	SCHNEIDER ELECTRIC	1
	JEU 4 PATTES DE FIXATION MURALE EN ACIER	NSYAEFPFSC	SCHNEIDER ELECTRIC	1
	PORTE SCHEMA A4	NSYDPA4	SCHNEIDER ELECTRIC	1
10E01	REPARTITEUR TETRAPOLAIRE TD 80/100 ALL, 14 CONNEXIONS	563940	ERICO	1
10E02	BARRETTE DE COUPURE BASSE, PLATINE PLASTIQUE 95x20mm, L = 125mm	034389	LEGRAND	1
10KA01	RELAIS INDUSTRIEL EMBROCHABLE, MONOSTABLE, 4INV, 24VAC + EMBASE + ETRIER	2903686 + 2900934 + 2908043	PHOENIX CONTACT	1
10PF01	RELAIS DE CONTROLE TRIPHASE POUR L'ORDRE ET LA PERTE DE PHASES, 208-480VAC, 1INV	DPA51CM44	CARLO GAVAZZI	1
10QD02	DISJONCTEUR IC60N 3P 1A, 440VAC/25kA, 133VDC/6kA, COURBE C	A9F74301	SCHNEIDER ELECTRIC	1
10QD03	DISJONCTEUR IC60N 2P 2A, 440VAC/25kA, 133VDC/6kA, COURBE C	A9F74202	SCHNEIDER ELECTRIC	1
10QD04	DISJONCTEUR DT40 1P+N 4A 6kA, COURBE C	A9N21022	SCHNEIDER ELECTRIC	1
10QIG01	INTERRUPTEUR DIFFERENTIEL IID TYPE AC 415VAC 4P 40A 300mA	A9R14440	SCHNEIDER ELECTRIC	1
10TR01	TRANSFORMATEUR DE COMMANDE ET DE SIGNALISATION MONOPHASEE 230-400V/24-48V, 100VA	044233	LEGRAND	1
12ECH01	RESISTANCE CHAUFFANTE PTC CS 060, 120-240V AC/DC, 50W	06000.0-00	STEGO	1
12ECL01	LAMPE LED 5W 220V 50-60Hz 500lm	NSYLAMT5LD1	SCHNEIDER ELECTRIC	1
12KTH01	PETIT THERMOSTAT KTO 011, 1NF, 0..60°C	01146.9-00	STEGO	1
12QD01	DISJONCTEUR DT40 VIGI 1P+N CLASSE AC 16A 30mA COURBE C	A9N21444	SCHNEIDER ELECTRIC	1
12QD02	DISJONCTEUR DT40 1P+N 1A 6kA, COURBE C	A9N21019	SCHNEIDER ELECTRIC	1
12QD03	DISJONCTEUR DT40 1P+N 1A 6kA, COURBE C	A9N21019	SCHNEIDER ELECTRIC	1
12S01	CONTACT DE PORTE	NSYINLCRN	SCHNEIDER ELECTRIC	1
12X01	PRISE DE COURANT 2P+T 10/16A, 250VAC A ECLIPS	004280	LEGRAND	1
15QD01	DISJONCTEUR DT40 1P+N 10A 6kA COURBE C	A9N21024	SCHNEIDER ELECTRIC	1
15QD02	DISJONCTEUR DT40 1P+N 10A 6kA COURBE C	A9N21024	SCHNEIDER ELECTRIC	1
20KA01	RELAIS DE CONTROLE 1-PHASE AC/DC MAXI TENSION, MAXI DE COURANT AC, 115-230VAC, 1INV	DUA01CB23 500V	CARLO GAVAZZI	1
20KA02	RELAIS DE CONTROLE 1-PHASE AC/DC MAXI TENSION, MAXI DE COURANT AC, 115-230VAC, 1INV	DUA01CB23 500V	CARLO GAVAZZI	1
20PA01	AMPEREMETRE ROTEX R72A90-A, 0-5A-25A/5A DEV. 90D	192D3300	SOCOMEK	1
	2 CAPUCHONS	192Z1016	SOCOMEK	1
20PA02	AMPEREMETRE ROTEX R72A90-A, 0-5A-25A/5A DEV. 90D	192D3300	SOCOMEK	1
	2 CAPUCHONS	192Z1016	SOCOMEK	1
20QD01	DISJONCTEUR DT40 1P+N 1A 6kA, COURBE C	A9N21019	SCHNEIDER ELECTRIC	1
20QD02	DISJONCTEUR MOTEUR MAGNETO-THERMIQUE 1.6-2.5A, BORNES A VIS	GV2ME07	SCHNEIDER ELECTRIC	1
	ADDITIF FRONTAL F+O	GVAE11	SCHNEIDER ELECTRIC	1
20QD03	DISJONCTEUR DT40 1P+N 1A 6kA, COURBE C	A9N21019	SCHNEIDER ELECTRIC	1
20QD04	DISJONCTEUR MOTEUR MAGNETO-THERMIQUE 1.6-2.5A, BORNES A VIS	GV2ME07	SCHNEIDER ELECTRIC	1
	ADDITIF FRONTAL F+O	GVAE11	SCHNEIDER ELECTRIC	1
20TC01	TRANSFORMATEUR DE COURANT A PRIMAIRE BOBINE 5/5A	192T0505	SOCOMEK	1
20TC02	TRANSFORMATEUR DE COURANT MONO, ENTREE 2-20A AC, SORTIE 0.4-4V	M120	CARLO GAVAZZI	1
20TC03	TRANSFORMATEUR DE COURANT A PRIMAIRE BOBINE 5/5A	192T0505	SOCOMEK	1
20TC04	TRANSFORMATEUR DE COURANT MONO, ENTREE 2-20A AC, SORTIE 0.4-4V	M120	CARLO GAVAZZI	1
23KA01	RELAIS DE CONTROLE DE NIVEAU, 2INV, ALIM. 24/230V AC/DC	RM35LM33MW	SCHNEIDER ELECTRIC	1
23QD01	DISJONCTEUR DT40 1P+N 2A 6kA, COURBE C	A9N21020	SCHNEIDER ELECTRIC	1
25E01	RACK S550 8 EMPLACEMENTS AVEC ALIM SECTEUR 230VAC	T9950A100	SOFREL	1
25E01-01	MODULE DE COMMUNICATION GSM/GPRS-3 + ANTENNE BI-BANDE	V5900540	SOFREL	1
25E01-02	MODULE D'ENTREES, 8E TOR	V5900210	SOFREL	1
25E01-03	MODULE D'ENTREES, 8E TOR	V5900210	SOFREL	1
25E01-04	MODULE DE SORTIES 2S 50V 1A	V5900320	SOFREL	1
25E01-05	MODULE D'ENTREES, 2E ANA MULTISTANDARD	V5900260	SOFREL	1



3, Rue Pierre Curie
91230 MONTGERON
Tél. : 01.69.52.47.00 - Fax : 01.69.52.47.01
e-mail : seguin@automatismes-seguin.fr
http://www.automatismes-seguin.fr

NOMENCLATURE

CLIENT ET NOM DU DOSSIER / CUSTOMER AND NAME OF FOLDER		INDICE / REVIEW
SAUR		0
Armoire De Supsression HERY		
DESSINATEUR DRAWER	M.H.	FOLIO/SHEET 60 / 61
N° AFFAIRE N° PROJECT	180319	
		IGE XAO VARZ SERVICE PACK 11-14-49-FI

REPERE	DESIGNATION	REFERENCE	MARQUE	QTE
25FP01	PROTECTION SECTEUR 230V, 5kA, Up=1.2kV	T5300011	SOFREL	1
25G01	BATTERIE 12V, 7Ah	NP7-12FR	YUASA	1
25QD01	DISJONCTEUR DT40 1P+N 4A 6kA, COURBE C	A9N21022	SCHNEIDER ELECTRIC	1
35KA01	RELAIS INDUSTRIEL EMBROCHABLE, MONOSTABLE, 4INV, 24VAC + EMBASE + ETRIER	2903686 + 2900934 + 2908043	PHOENIX CONTACT	1
35KA02	RELAIS INDUSTRIEL EMBROCHABLE, MONOSTABLE, 4INV, 24VAC + EMBASE + ETRIER	2903686 + 2900934 + 2908043	PHOENIX CONTACT	1
36F01	RELAIS DE PROTECTION THERMIQUE 0.16-0.25A	LRD02	SCHNEIDER ELECTRIC	1
	BORNIER DE RELAIS THERMIQUE POUR ENCLIQUEPAGE SUR PROFILE DE 35mm	LAD7B106	SCHNEIDER ELECTRIC	1
36F02	RELAIS DE PROTECTION THERMIQUE 0.16-0.25A	LRD02	SCHNEIDER ELECTRIC	1
	BORNIER DE RELAIS THERMIQUE POUR ENCLIQUEPAGE SUR PROFILE DE 35mm	LAD7B106	SCHNEIDER ELECTRIC	1
36KA01	RELAIS INDUSTRIEL EMBROCHABLE, MONOSTABLE, 4INV, 24VAC + EMBASE + ETRIER	2903686 + 2900934 + 2908043	PHOENIX CONTACT	1
36KA02	RELAIS INDUSTRIEL EMBROCHABLE, MONOSTABLE, 4INV, 24VAC + EMBASE + ETRIER	2903686 + 2900934 + 2908043	PHOENIX CONTACT	1
36KA03	RELAIS INDUSTRIEL EMBROCHABLE, MONOSTABLE, 4INV, 24VAC + EMBASE + ETRIER	2903686 + 2900934 + 2908043	PHOENIX CONTACT	1
36KA04	RELAIS INDUSTRIEL EMBROCHABLE, MONOSTABLE, 4INV, 24VAC + EMBASE + ETRIER	2903686 + 2900934 + 2908043	PHOENIX CONTACT	1
36KA05	RELAIS INDUSTRIEL EMBROCHABLE, MONOSTABLE, 4INV, 24VAC + EMBASE + ETRIER	2903686 + 2900934 + 2908043	PHOENIX CONTACT	1
36KA06	RELAIS INDUSTRIEL EMBROCHABLE, MONOSTABLE, 4INV, 24VAC + EMBASE + ETRIER	2903686 + 2900934 + 2908043	PHOENIX CONTACT	1
36S01	TETE BOUTON POUSSOIR BLEU	ZB4BA6	SCHNEIDER ELECTRIC	1
	CORPS CONTACT NO	ZB4BZ101	SCHNEIDER ELECTRIC	1
37KA01	RELAIS INDUSTRIEL EMBROCHABLE, MONOSTABLE, 4INV, 24VAC + EMBASE + ETRIER	2903686 + 2900934 + 2908043	PHOENIX CONTACT	1
37KA02	RELAIS PERMUTATION FLIP FLOP 24VAC + EMBASE DE RELAIS DETECTEUR DE NIVEAUX S 196 + ETRIER	SL150024 + ZPD11 + HF	CARLO GAVAZZI	1
37KM01	CONTACTEUR DE PUISSANCE 9A 1NO+1NF 24V 50/60Hz	LC1D09B7	SCHNEIDER ELECTRIC	1
	BLOC DE CONTACTS AUXILIAIRES 2NO FRONTAL	LADN20	SCHNEIDER ELECTRIC	1
37KM02	CONTACTEUR DE PUISSANCE 9A 1NO+1NF 24V 50/60Hz	LC1D09B7	SCHNEIDER ELECTRIC	1
	BLOC DE CONTACTS AUXILIAIRES 2NO FRONTAL	LADN20	SCHNEIDER ELECTRIC	1
37PCH01	COMPTEUR HORAIRE TOTALISATEUR 10...30V, 50Hz	3220401071	KUBLER	1
	CADRE POUR COMPTEUR DIN H57	BT008171	KUBLER	1
37PCH02	COMPTEUR HORAIRE TOTALISATEUR 10...30V, 50Hz	3220401071	KUBLER	1
	CADRE POUR COMPTEUR DIN H57	BT008171	KUBLER	1
37S01	TETE BOUTON TOURNANT 3 POSITIONS, RAPPEL DE DROITE AU CENTRE	ZB4BD8	SCHNEIDER ELECTRIC	1
	CORPS CONTACT 2NO	ZB4BZ103	SCHNEIDER ELECTRIC	1
	CONTACT VIS ETRIER 1NO	ZBE101	SCHNEIDER ELECTRIC	1
	CONTACT VIS ETRIER 1NF	ZBE102	SCHNEIDER ELECTRIC	1
37S02	TETE BOUTON TOURNANT 3 POSITIONS, RAPPEL DE DROITE AU CENTRE	ZB4BD8	SCHNEIDER ELECTRIC	1
	CORPS CONTACT 2NO	ZB4BZ103	SCHNEIDER ELECTRIC	1
	CONTACT VIS ETRIER 1NO	ZBE101	SCHNEIDER ELECTRIC	1
	CONTACT VIS ETRIER 1NF	ZBE102	SCHNEIDER ELECTRIC	1
45H01	VOYANT INCOLORE DEL 24V	XB7EV07BP	SCHNEIDER ELECTRIC	1
45H02	VOYANT VERT DEL 24V	XB7EV03BP	SCHNEIDER ELECTRIC	1
45H03	VOYANT ROUGE DEL 24V	XB7EV04BP	SCHNEIDER ELECTRIC	1
45H04	VOYANT VERT DEL 24V	XB7EV03BP	SCHNEIDER ELECTRIC	1
45H05	VOYANT ROUGE DEL 24V	XB7EV04BP	SCHNEIDER ELECTRIC	1
45H06	VOYANT ROUGE DEL 24V	XB7EV04BP	SCHNEIDER ELECTRIC	1



3, Rue Pierre Curie
91230 MONTGERON
Tél. : 01.69.52.47.00 - Fax : 01.69.52.47.01
e-mail : seguin@automatismes-seguin.fr
http://www.automatismes-seguin.fr

NOMENCLATURE

CLIENT ET NOM DU DOSSIER / CUSTOMER AND NAME OF FOLDER		INDICE / REVIEW
SAUR		0
Armoire De Supsression HERY		
DESSINATEUR DRAWER	M.H.	FOLIO/SHEET 61 / 61
N° AFFAIRE N° PROJECT	180319	
		IGE XAO VARZ SERVICE PACK 11-14-49-FI