

08/11/2018	0	K.C.	RETOUR ESSAIS	F.C.	R.M.
12/10/2018	A	M.H.	PREMIERE EMISSION	F.C.	R.M.
DATE	REV.	DESSINE PAR	MODIFICATIONS	VERIFIE PAR	APPROUVE PAR
DATE	REV.	DRAWN BY	REVISIONS	CHECKED BY	APPROVED BY

***SCHEMA ELECTRIQUE  
ELECTRICAL DRAWING***



3, Rue Pierre Curie  
91230 MONTGERON  
Tél. : 01.69.52.47.00 - Fax : 01.69.52.47.01  
e-mail : [seguin@automatismes-seguin.fr](mailto:seguin@automatismes-seguin.fr)  
<http://www.automatismes-seguin.fr>

PLAN: 180336	REV: 0
CDE: 18049723YP00900	

Ce document est notre propriété. Il ne peut être reproduit et / ou communiqué sans autorisation.  
This document is our property. It cannot be reproduced and / or transmitted without authorization.



***Armoire Station Silo  
La Chapelle La Reine***



LETTRE DE REPERAGE DES ELEMENTS DU SCHEMA

QI	INTERRUPTEUR	PCPI	CONTROLEUR D'ISOLEMENT	KT	RELAIS TEMPORISE	SA	COMMUTATEUR D'AMPEREMETRE
QIG	INTERRUPTEUR GENERAL	TR	TRANSFORMATEUR DE TENSION	KAU	RELAIS ARRET D'URGENCE	SV	COMMUTATEUR DE VOLTMETRE
QD	DISJONCTEUR	TC	TRANSFORMATEUR DE COURANT	UF	VARIATEUR	ECH	RESISTANCE CHAUFFANTE
QDG	DISJONCTEUR GENERAL	U	ONDULEUR, ALIMENTATION	UM	DEMARREUR	ECL	ECLAIRAGE
FP	PARAFONDRE	KIC	INTER CREPUSCULAIRE	S	ORGANE DE COMMANDE	G	BATTERIE
FU	FUSIBLE	KIH	HORLOGE	H	VOYANT, SIRENE	P	INSTRUMENTATION
F	THERMIQUE	KTH	THERMOSTAT	PCH	COMPTEUR HORAIRE	X	PRISE DE COURANT, BORNIER
QF	SECTIONNEUR FUSIBLE	KM	CONTACTEUR	PA	AMPEREMETRE	E	MATERIELS AUTRES
PF	CONTROLEUR DE PHASE	KA	RELAIS	PV	VOLTMETRE	KTL	TELERUPTEUR

LETTER CODES FOR ITEMS DESIGNATION ON THE DRAWING

QI	SWITCH	PCPI	INSULATION CONTROLLER	KT	TEMPORIZES RELAY	SA	AMPEREMETER SWITCH
QIG	GENERAL SWITCH	TR	TENSION TRANSFORMER	KAU	EMERGENCY STOP RELAY	SV	VOLTMETER SWITCH
QD	BREAKER	TC	CURRENT TRANSFORMER	UF	VELOCITY VARIATOR	ECL	LIGHT
QDG	GENERAL BREAKER	U	INVERTER, SUPPLY	UM	MOTOR STARTER	ECH	HEATER
FP	LIGHTNING PROTECTOR	KIC	DIMMER	S	CONTROL UNIT	G	BATTERY
FU	FUSE	KIH	CLOCK	H	INDICATOR	P	INSTRUMENTATION
F	THERMAL RELAY	KTH	THERMOSTAT	PCH	TIMER	X	SOCKET, TERMINAL BLOCK
QF	DISCONNECTING SWITCH	KM	CONTACTOR	PA	AMPEREMETER	E	OTHER EQUIPMENTS
PF	PHASE CONTROLLER	KA	RELAY	PV	VOLTMETER	KTL	TELEBREAKER

COULEURS DE FILS

TRI 400V: <= 6 mm2 Noir Rouge Brun  
> 6 mm2 Noir Bagué Noir Rouge Brun

NEUTRE: Bleu Clair

230VAC: Rouge avec Commun Bobines Blanc (\*)

230VAC ONDULE: Neutre Bleu Clair Bagué Orange  
Phase Noir Bagué Orange

110VAC: Noir avec Commun Bobines Blanc (\*)

24VAC: Violet avec Commun Bobines Blanc (\*)

24VDC: Bleu Foncé avec Commun Bobines Blanc (\*)

48VAC: Violet avec Commun Bobines Blanc (\*)

48VDC: Bleu Foncé avec Commun Bobines Blanc (\*)

REPORTS: Orange

TERRE: Vert/Jaune

ANALOGIQUE: Une Paire + Brun - Blanc  
Unifilaire Blanc

TENSION EXTERNE PERMANENTE INTER GENERAL OUVERT: Orange

ATTENTION

Si plusieurs tensions de télécommande, alors prendre uniquement le 230VAC avec Commun Bobines Blanc

(\*) Si Télécommande

WIRE COLOR

TRI 400V: <= 6 mm2 Black Red Brown  
> 6 mm2 Black with Ring Black Red Brown

NEUTRE: Light Blue

230VAC: Red with Spods Common White (\*)

230VAC UPS: Neutre Light Blue with Ring Orange  
Phase Black with Ring Orange

110VAC: Black with Spods Common White (\*)

24VAC: Purple with Spods Common White (\*)

24VDC: Dark Bleu with Spods Common White (\*)

48VAC: Purple with Spods Common White (\*)

48VDC: Dark Bleu with Spods Common White (\*)

REPORTS: Orange

GROUND: Green/Yellow

ANALOGICAL: One Pair + Brown - White  
Unifilar White

PERMANENTLY EXTERNAL POWER GENERAL BREAKER OPEN: Orange

CAUTION

If There are Several Tensions of Command Then to take Only the 230VAC with Spods Common White

(\*) If Command

TYPE DE RELAIS ET DE CONTACT DANS LE SCHEMA

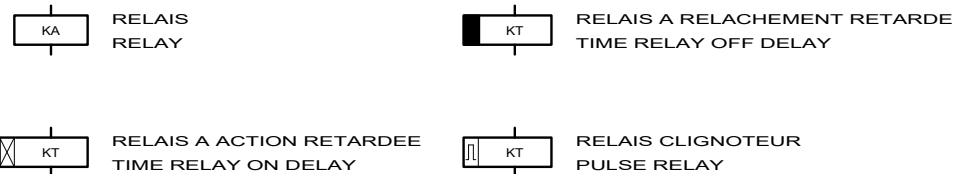

RELAY AND CONTACT TYPE IN THE DRAWING

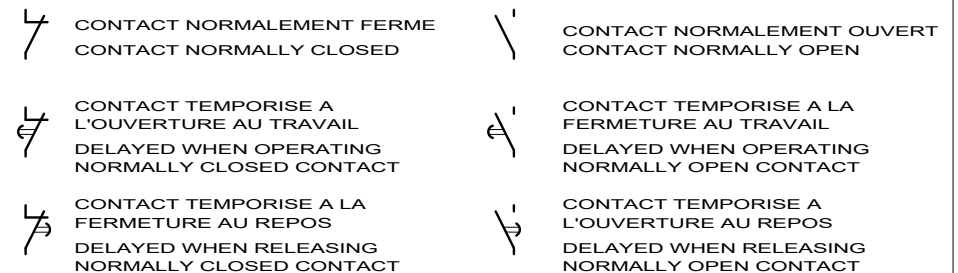

LE SCHEMA EST REPRESENTE HORS TENSION ET GENERATEUR HORS SERVICE

THE DRAWING IS SHOWN OUT OF VOLTAGE AND WITH GENERATOR OUT OF SERVICE



3, Rue Pierre Curie  
91230 MONTGERON  
Tél. : 01.69.52.47.00 - Fax : 01.69.52.47.01  
e-mail : seguin@automatismes-seguin.fr  
http://www.automatismes-seguin.fr

LEGENDE DU SCHEMA ELECTRIQUE

CLIENT ET NOM DU DOSSIER / CUSTOMER AND NAME OF FOLDER		INDICE / REVIEW
SAUR		0
Armoire Station Silo		
DESSINATEUR / DRAWER	M.H.	IGE XAO
N° AFFAIRE / N° PROJECT	180336	FOLIO/SHEET 03/04
		VARS SERVICE PACK 4 - (L84C)

CODE DU REPERAGE

LETTER CODE

1/ DES APPAREILS DANS LES ARMOIRES  
APPARATUS IN THE CABINETS



EXEMPLE:KA RELAIS  
EXAMPLE:KA RELAY

52 KA 01

N° D'ORDRE DANS LE FOLIO D'ORIGINE  
ORDER NUMBER ON ORIGINAL SHEET

LETTRE DE REPERAGE  
LETTER CODES FOR ITEM

N° DU FOLIO D'ORIGINE  
ORIGINAL SHEET NUMBER

2/ DES FILS DE CABLAGE  
WIRING

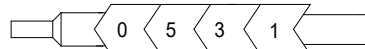

N° DU FOLIO D'ORIGINE  
ORIGINAL SHEET NUMBER

N° DU FIL DANS LE FOLIO D'ORIGINE  
NUMBER OF THE WIRE ON ORIGINAL SHEET

3/ REPORT DES CONTACTS DANS LE SCHEMA  
CONTACT REPORT IN THE DRAWING

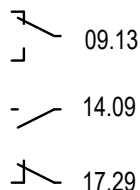

17.29

N° DE LA COLONNE OU EST UTILISE LE CONTACT  
COLUMN NUMBER WHERE THE CONTACT IS USED

N° DU FOLIO OU EST UTILISE LE CONTACT  
SHEET NUMBER WHERE THE CONTACT IS USED

4/ REPRESENTATION DES BORNES ET BORNIERES DANS LE SCHEMA  
BINDINGS SCREWS VIEW IN THE DRAWING



N° D'ORDRE (SI NECESSAIRE)  
ORDER NUMBER (IF NECESSARY)

NATURE DU BORNIER  
NATURE OF TERMINAL BLOCK

A : ALIMENTATION  
P : PUISSANCE  
T : TELECOMMANDE  
M : MESURE  
R : REPORTS



LE SCHEMA EST REPRESENTE HORS TENSION ET GENERATEUR HORS SERVICE

THE DRAWING IS SHOWN OUT OF VOLTAGE AND WITH GENERATOR OUT OF SERVICE



3, Rue Pierre Curie  
91230 MONTGERON  
Tél. : 01.69.52.47.00 - Fax : 01.69.52.47.01  
e-mail : seguin@automatismes-seguin.fr  
http://www.automatismes-seguin.fr

LEGENDE DU SCHEMA ELECTRIQUE

CLIENT ET NOM DU DOSSIER / CUSTOMER AND NAME OF FOLDER			INDICE / REVIEW
SAUR			0
Armoire Station Silo			
DESSINATEUR DRAWER	M.H.	FOLIO/SHEET	04 / 05
N° AFFAIRE N° PROJECT	180336		
			IGE-XAO VAR3 SERVICE PACK 4 - (L84C)

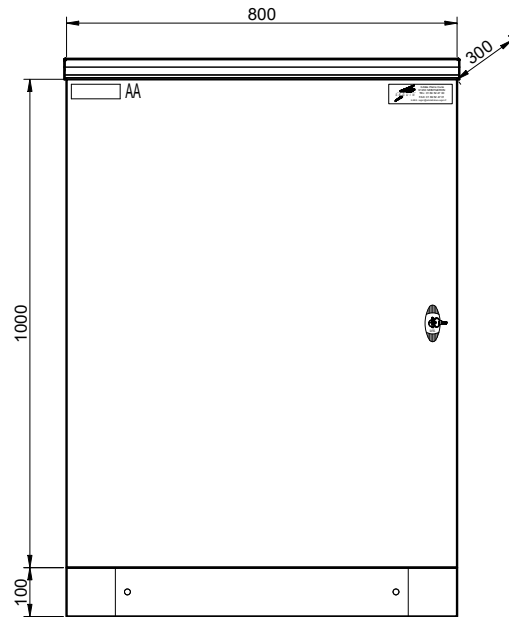

**ETIQUETTES 100x30**

AA - STATION SILO LA CHAPELLE LA REINE

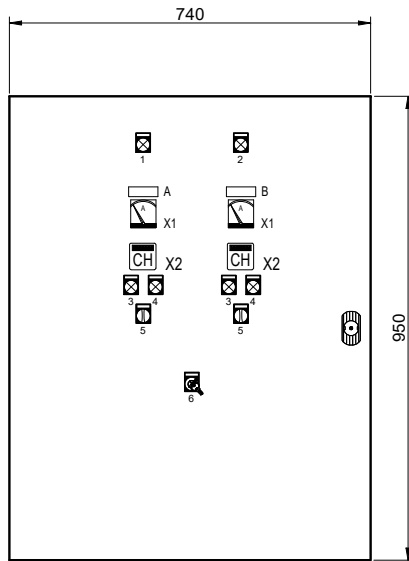

PORTE INTERIEURE

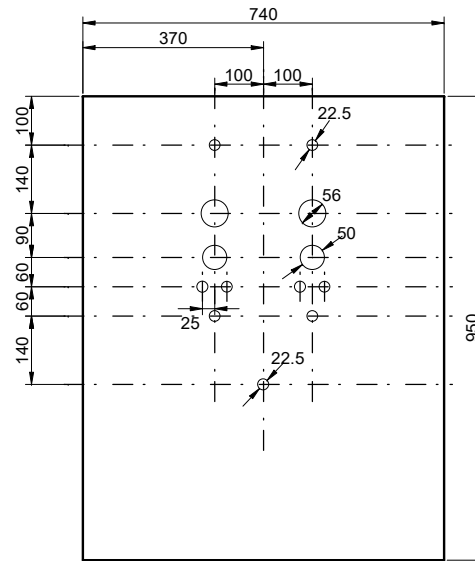

PLAN DE DECOUPE  
PORTE INTERIEURE

ETIQUETTES 60x20

- A - POMPE 1
- B - POMPE 2

ETIQUETTES SCHNEIDER

- 1 - SOUS TENSION
- 2 - NIVEAU TROP PLEIN
- 3 - MARCHE
- 4 - DEFAUT
- 5 - AUTO / 0 / MAIN
- 6 - NORMAL / INTERVENTION

DIVERS

- X1 - AMPEREMETRE
- X2 - COMPTEUR HORAIRE

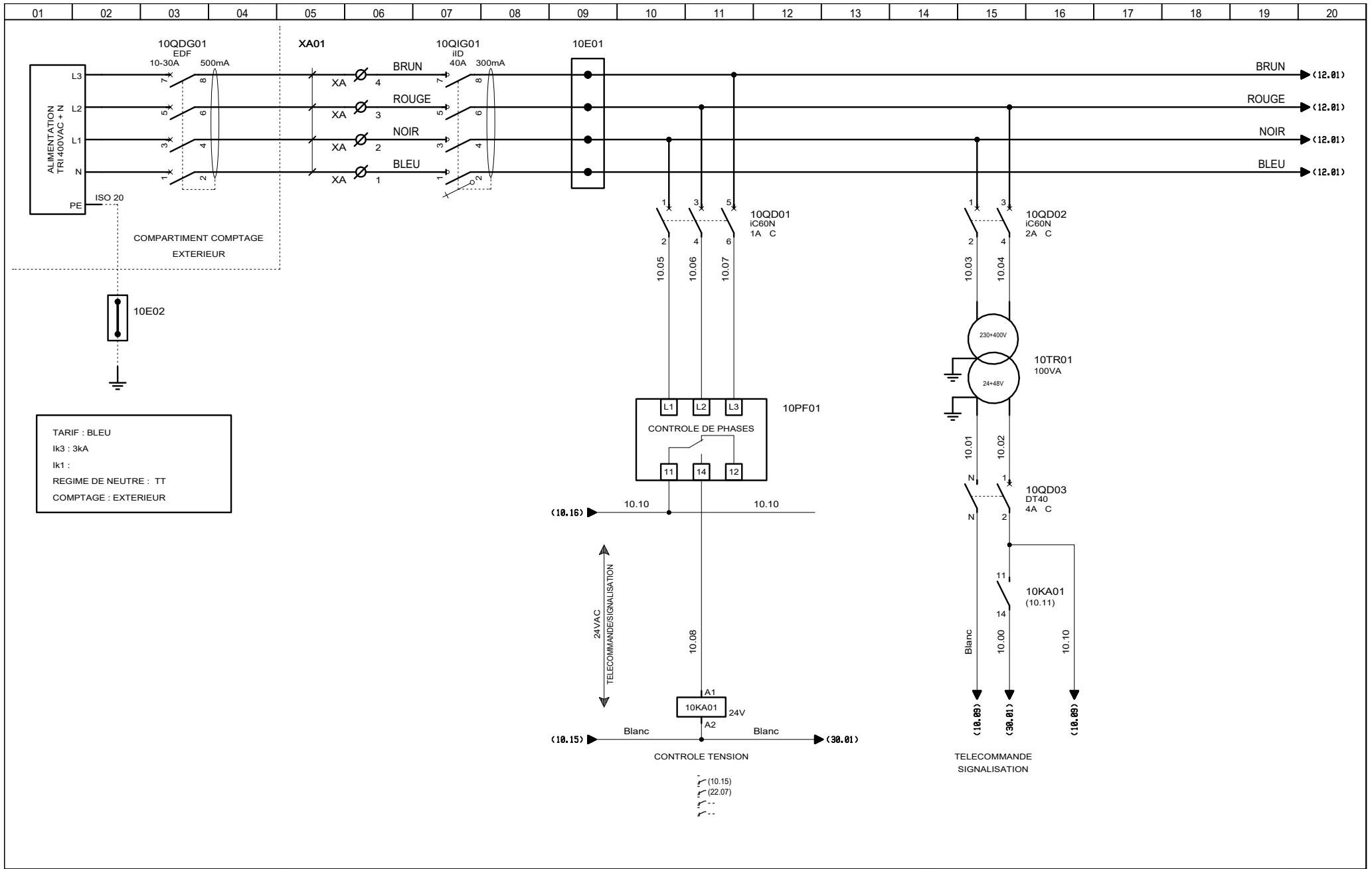

3, Rue Pierre Curie  
91230 MONTGERON  
Tél. : 01.69.52.47.00 - Fax : 01.69.52.47.01  
e-mail : seguin@automatismes-seguin.fr  
http://www.automatismes-seguin.fr

### ARRIVEE GENERALE

CLIENT ET NOM DU DOSSIER / CUSTOMER AND NAME OF FOLDER		INDICE / REVIEW
SAUR		0
Armoire Station Silo		
DESSINATEUR DRAWER	M.H.	FOLIO/SHEET 10 / 12
N° AFFAIRE N° PROJECT	180336	
VAR3 SERVICE PACK 4 - (4.84C)		

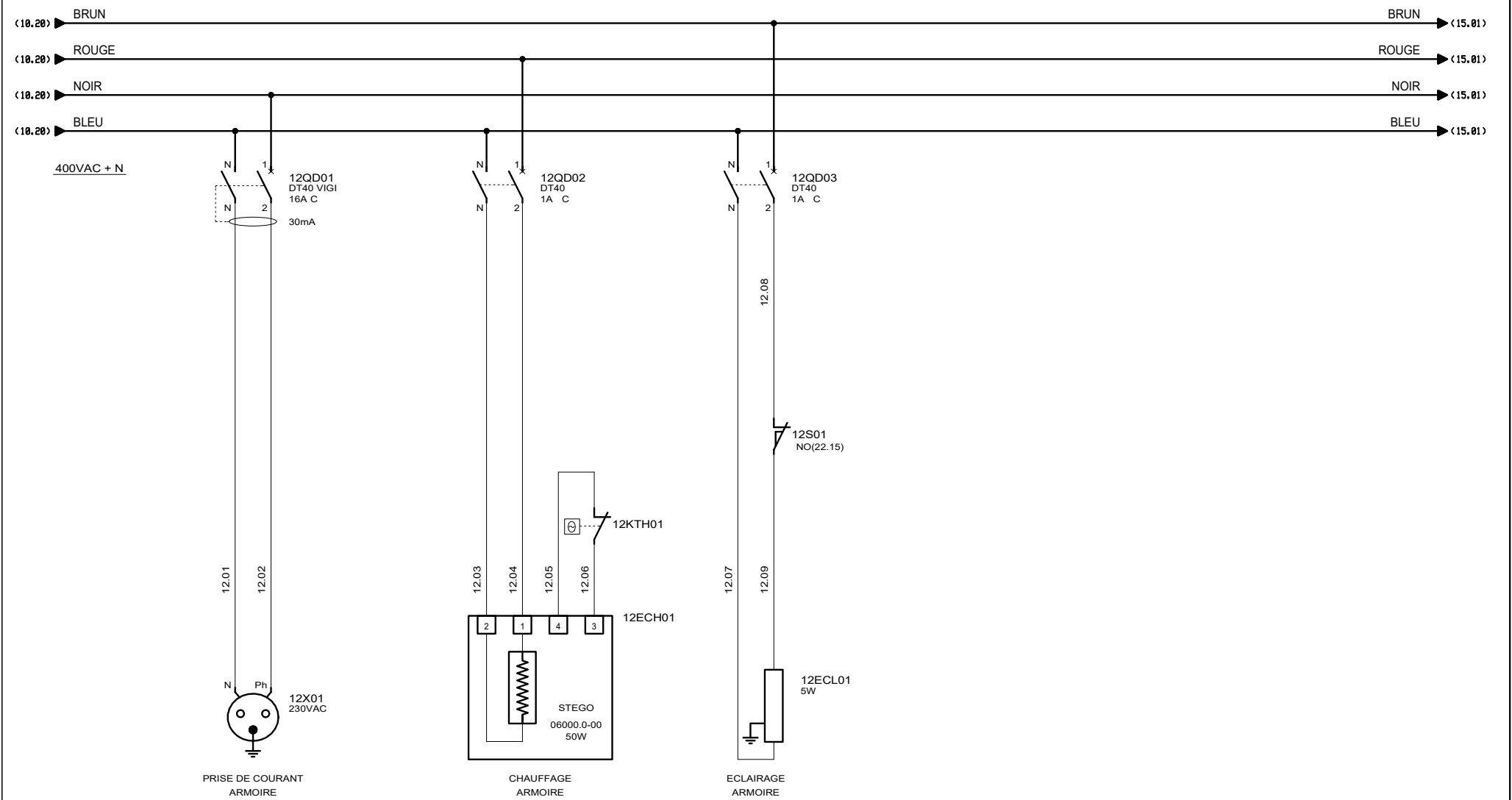

**AUTOMATISMES SEGUIN**  
 Systeme Qualité  
 3, Rue Pierre Curie  
 91230 MONTGERON  
 Tél. : 01.69.52.47.00 - Fax : 01.69.52.47.01  
 e-mail : seguin@automatismes-seguin.fr  
 http://www.automatismes-seguin.fr

## DISTRIBUTION 400VAC + N UTILITES

CLIENT ET NOM DU DOSSIER / CUSTOMER AND NAME OF FOLDER		INDICE / REVIEW
SAUR Armoire Station Silo		0
DESSINATEUR DRAWER	M.H.	FOLIO/SHEET 12 / 15
N° AFFAIRE N° PROJECT	180336	
VARS SERVICE PACK 4 - (4.843)		

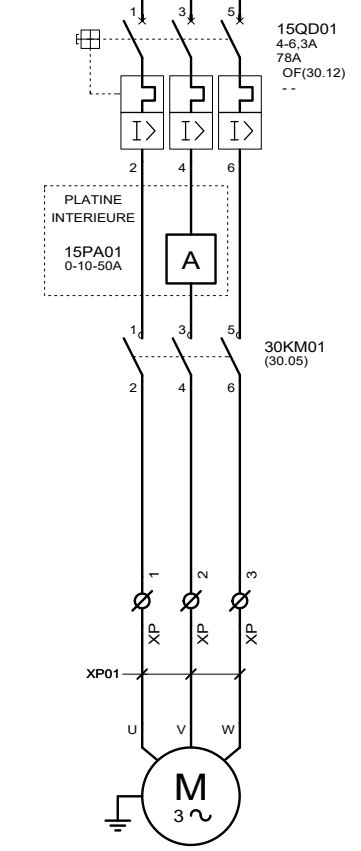
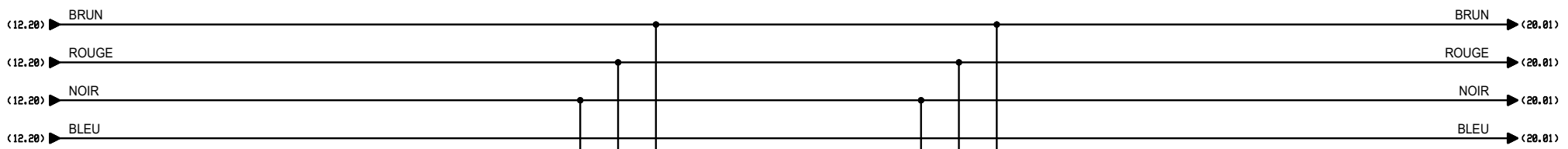

POMPE 1	
Pmax	* kW
In	* A

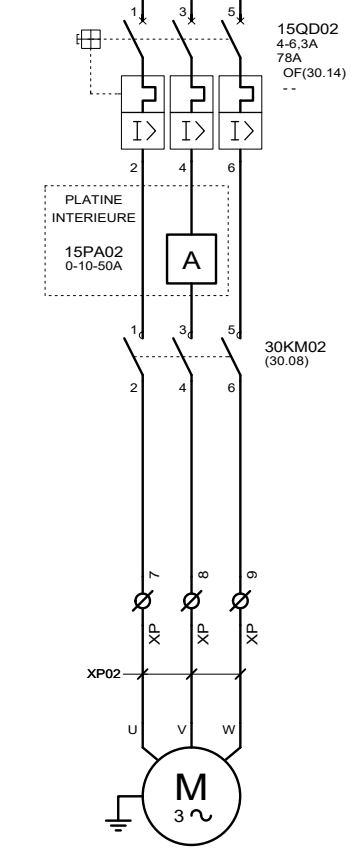

POMPE 2	
Pmax	* kW
In	* A

**AUTOMATISMES SEGUIN**  
 Systeme Qualité

3, Rue Pierre Curie  
 91230 MONTGERON  
 Tél. : 01.69.52.47.00 - Fax : 01.69.52.47.01  
 e-mail : seguin@automatismes-seguin.fr  
 http://www.automatismes-seguin.fr

### PUISSANCE POMPES

CLIENT ET NOM DU DOSSIER / CUSTOMER AND NAME OF FOLDER			INDICE / REVIEW	
SAUR			0	
Armoire Station Silo			<b>IGE-XAO</b>	
DESSINATEUR DRAWER	M.H.	FOLIO/SHEET		15 / 20
N° AFFAIRE N° PROJECT	180336			
VAR3 SERVICE PACK 4 - (4.843)				

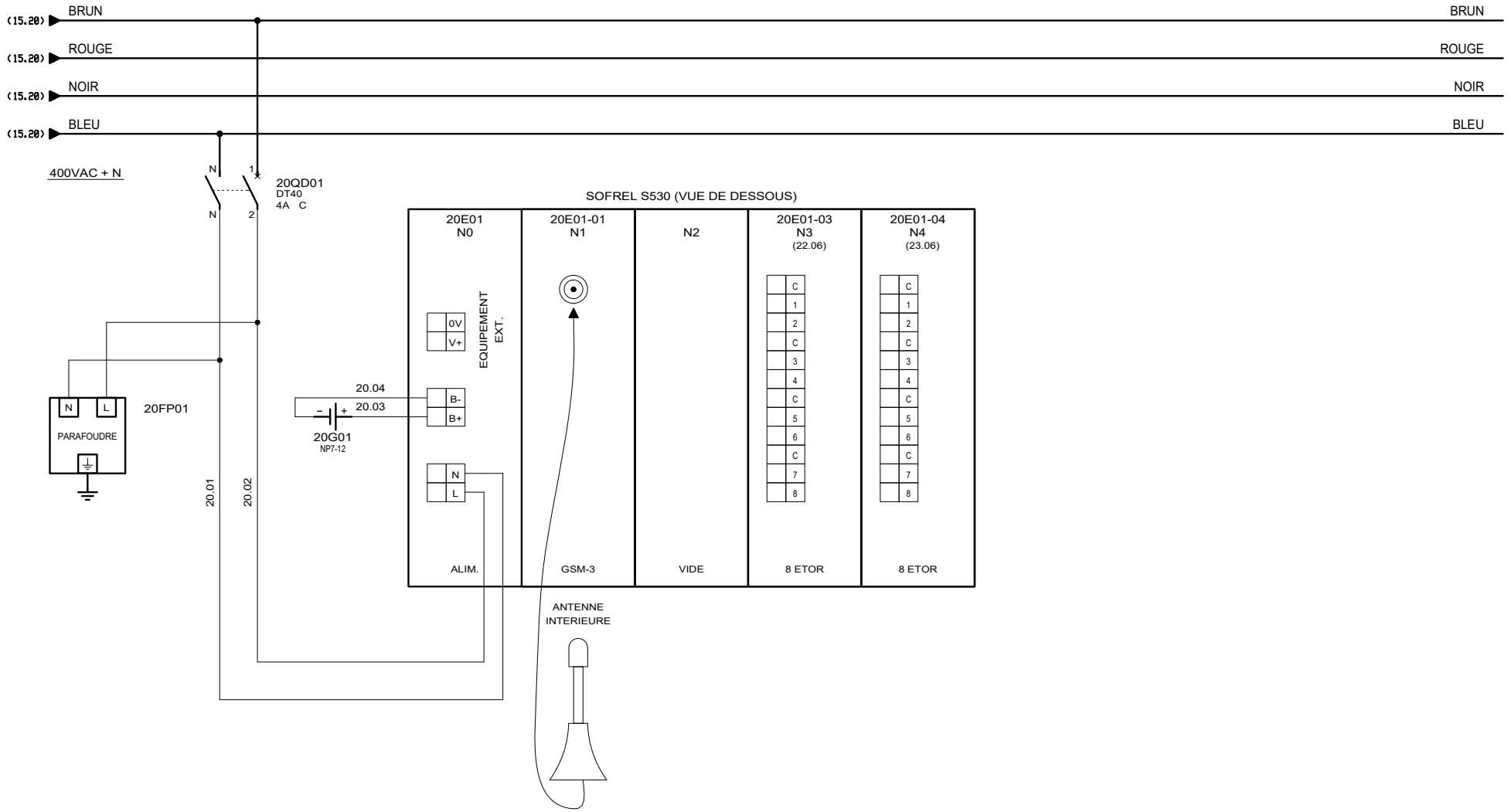

### ALIMENTATION SOFREL S530

CLIENT ET NOM DU DOSSIER / CUSTOMER AND NAME OF FOLDER		INDICE / REVIEW
SAUR		0
Armoire Station Silo		
DESSINATEUR / DRAWER	M.H.	FOLIO/SHEET 20 / 22
N° AFFAIRE / N° PROJECT	180336	
		IGE-XAO
		VAR3 SERVICE PACK 4 - (4.843)

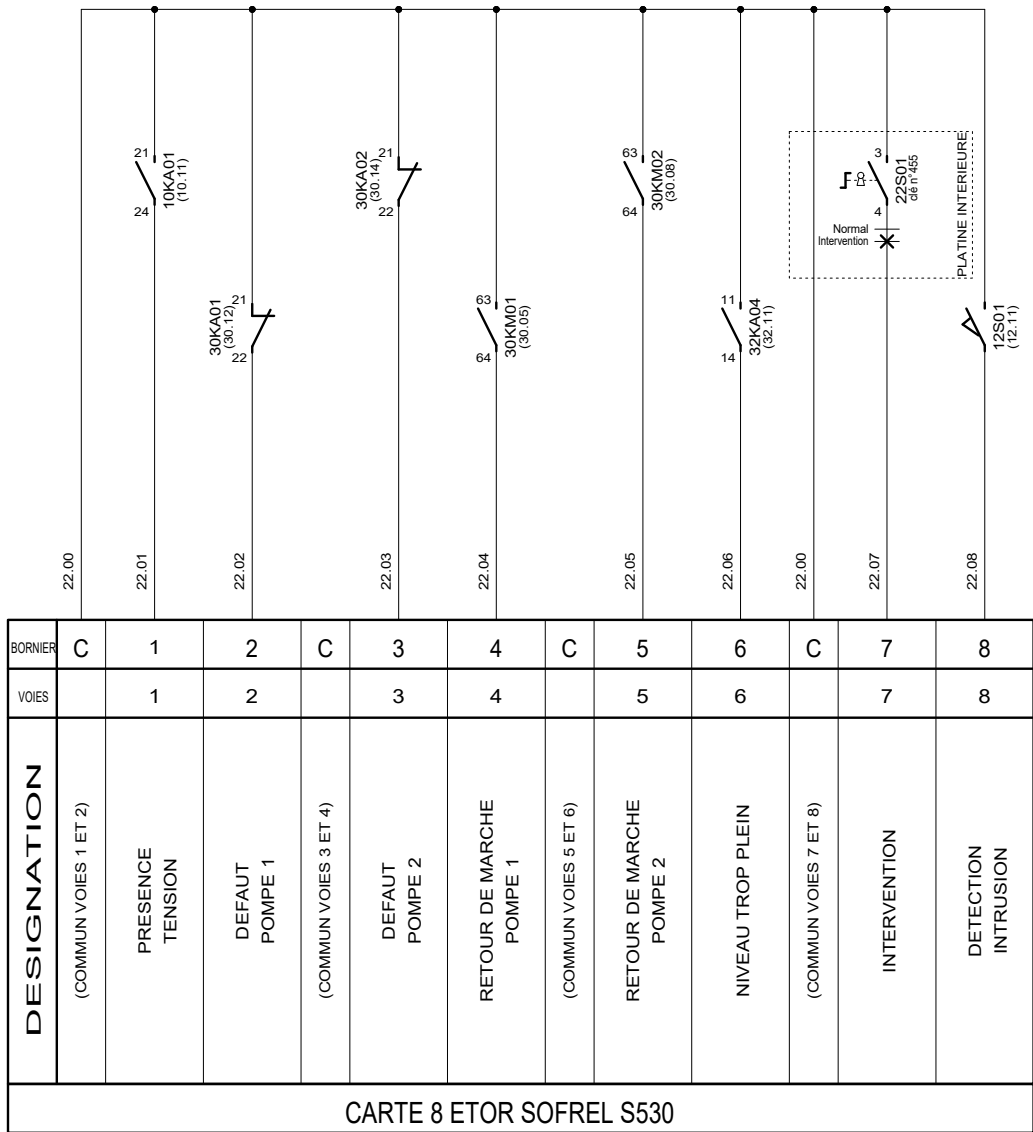

20E01-03  
(20.10)

**CARTE 8 ENTrees TOR  
EMPLACEMENT 3**

CLIENT ET NOM DU DOSSIER / CUSTOMER AND NAME OF FOLDER		INDICE / REVIEW
SAUR Armoire Station Silo		0
DESSINATEUR DRAWER	M.H.	FOLIO/SHEET 22 / 23
N° AFFAIRE N° PROJECT	180336	
		VARS SERVICE PACK 4 - (A.84C)

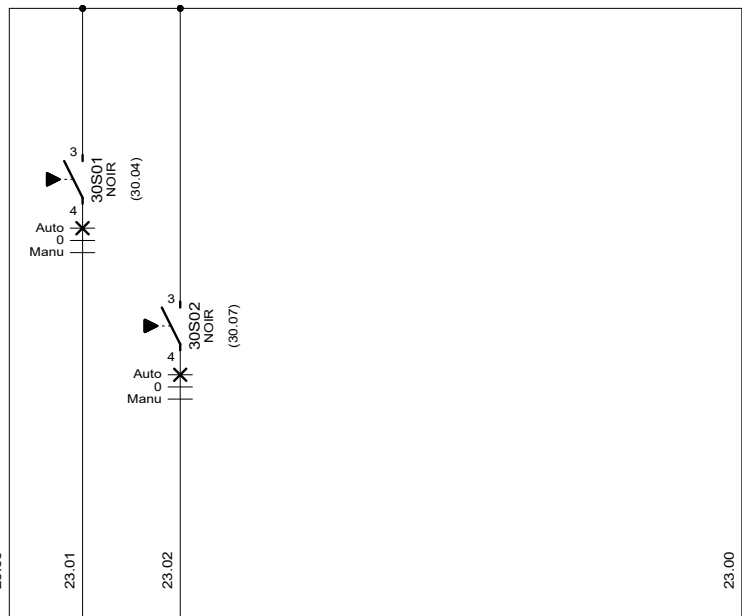

BORNIER	C	1	2	C	3	4	C	5	6	C	7	8
VOIES		1	2		3	4		5	6		7	8
DESIGNATION		(COMMUN VOIES 1 ET 2)	POSITION AUTO POMPE 1	POSITION AUTO POMPE 2	(COMMUN VOIES 3 ET 4)		(COMMUN VOIES 5 ET 6)			(COMMUN VOIES 7 ET 8)		
CARTE 8 ETOR SOFREL S530												

20E01-04  
(20.11)



3, Rue Pierre Curie  
91230 MONTGERON  
Tél. : 01.69.52.47.00 - Fax : 01.69.52.47.01  
e-mail : seguin@automatismes-seguin.fr  
http://www.automatismes-seguin.fr

### CARTE 8 ENTrees TOR EMPLACEMENT 4

CLIENT ET NOM DU DOSSIER / CUSTOMER AND NAME OF FOLDER		INDICE / REVIEW
SAUR Armoire Station Silo		0
DESSINATEUR DRAWER	M.H.	FOLIO/SHEET 23 / 30
N° AFFAIRE N° PROJECT	180336	
		<small>IGE XAO VAR3 SERVICE PACK 4 - (4.843)</small>

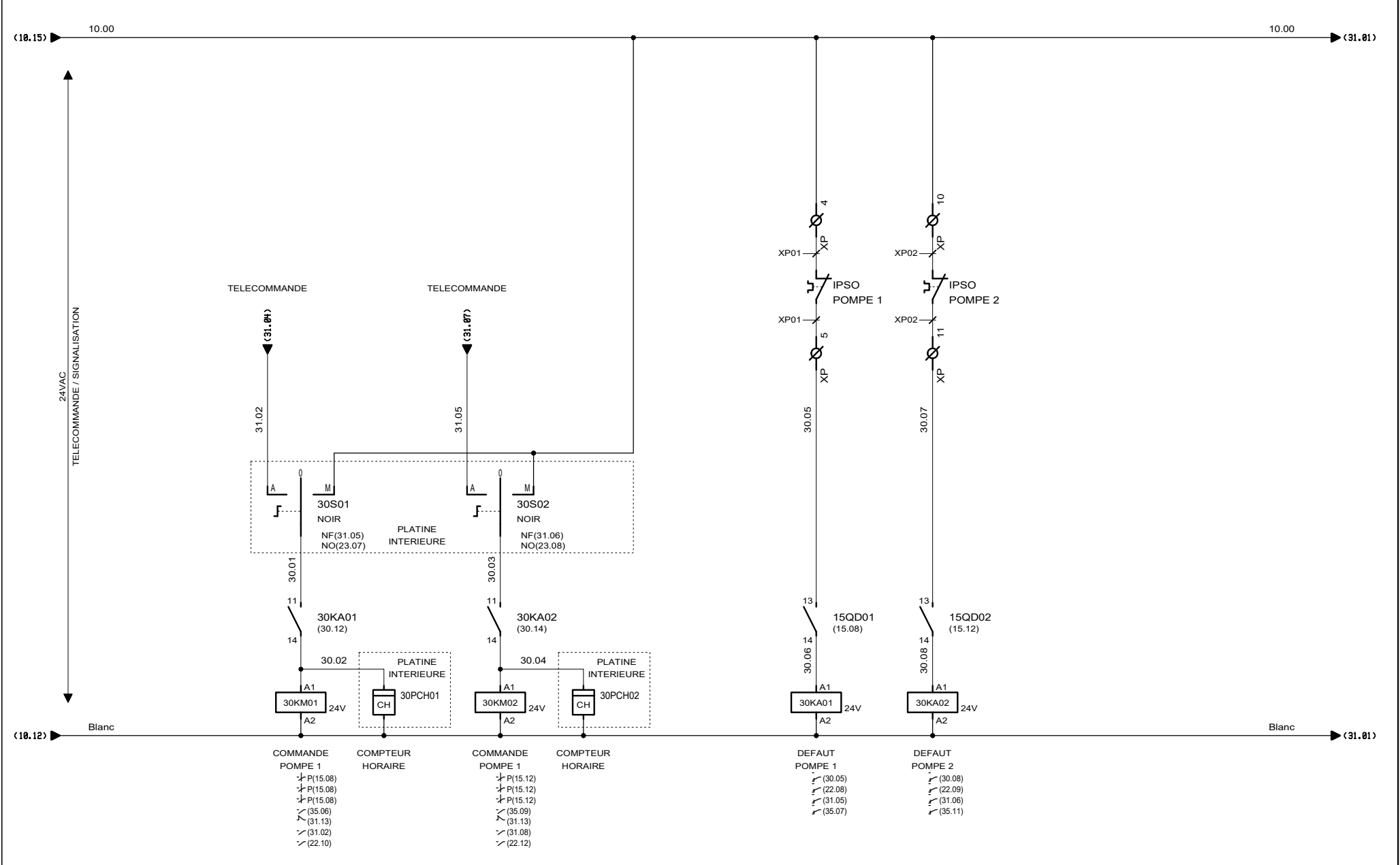

**AUTOMATISMES SEGUIN**  
 Systeme Qualité

3, Rue Pierre Curie  
 91230 MONTGERON  
 Tél. : 01.69.52.47.00 - Fax : 01.69.52.47.01  
 e-mail : seguin@automatismes-seguin.fr  
 http://www.automatismes-seguin.fr

**TELECOMMANDE POMPES**

CLIENT ET NOM DU DOSSIER / CUSTOMER AND NAME OF FOLDER		INDICE / REVIEW
SAUR		0
Armoire Station Silo		
DESSINATEUR / DRAWER	M.H.	FOLIO/SHEET 30 / 31
N° AFFAIRE / N° PROJECT	180336	
VARS SERVICE PACK 4 - (L84C)		

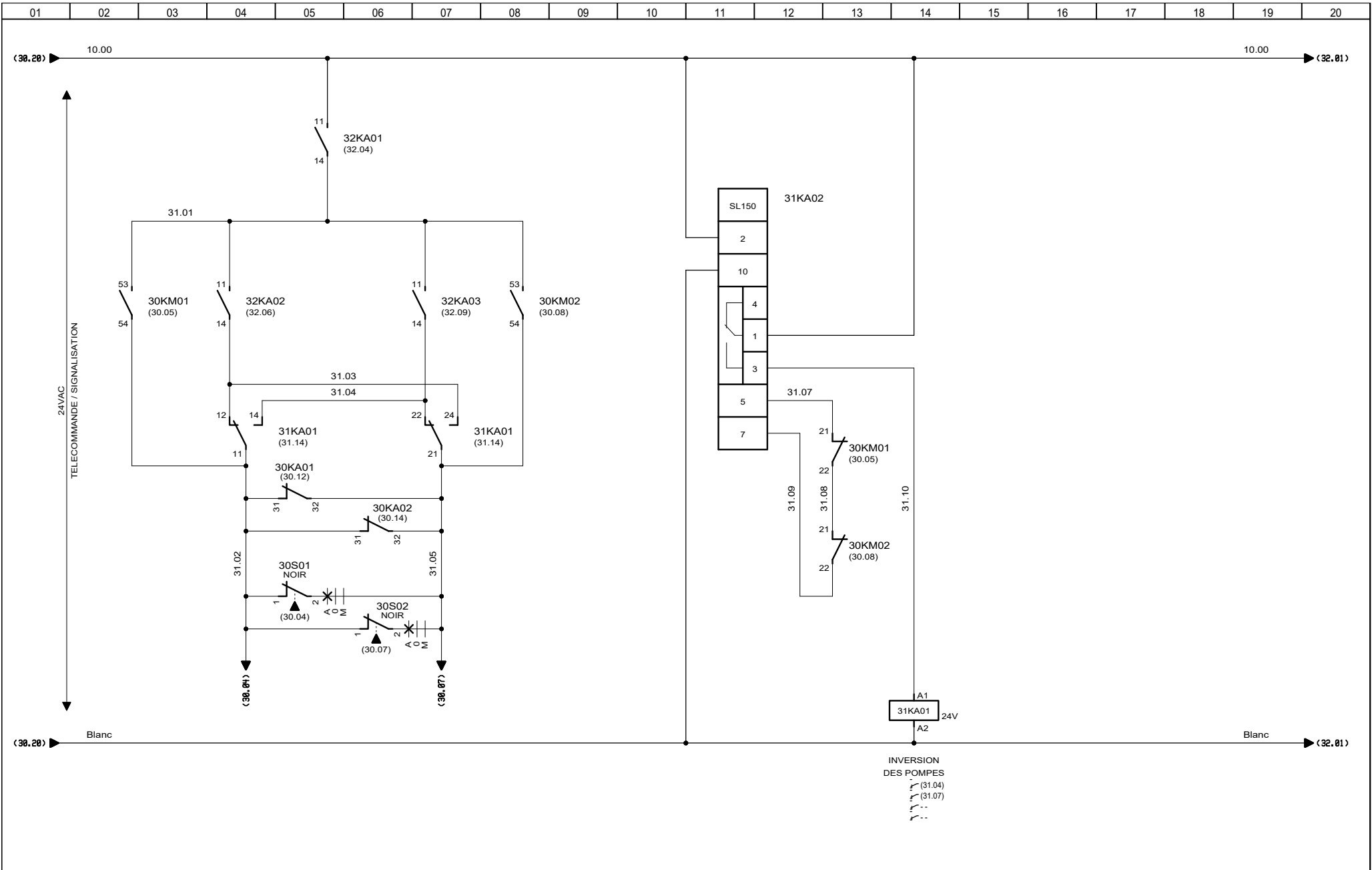



 3, Rue Pierre Curie  
 91230 MONTGERON  
 Tél. : 01.69.52.47.00 - Fax : 01.69.52.47.01  
 e-mail : seguin@automatismes-seguin.fr  
 http://www.automatismes-seguin.fr

## TELECOMMANDE POMPES

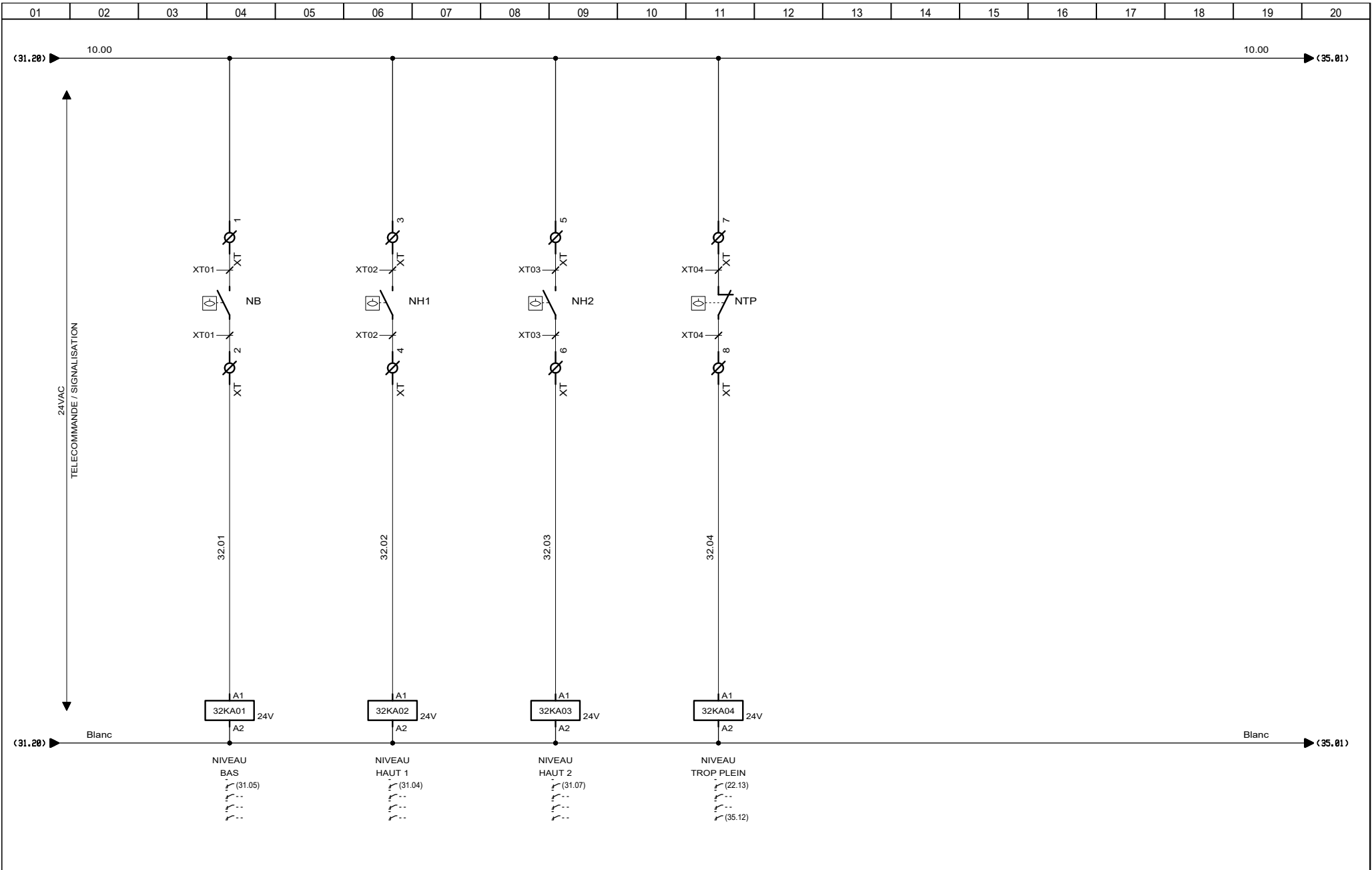
CLIENT ET NOM DU DOSSIER / CUSTOMER AND NAME OF FOLDER		INDICE / REVIEW
SAUR		0
Armoire Station Silo		
DESSINATEUR DRAWER	M.H.	FOLIO/SHEET 31/32
N° AFFAIRE N° PROJECT	180336	IGE-XAO <small>VAR3 SERVICE PACK 4 - (4.84C)</small>



 3, Rue Pierre Curie  
 91230 MONTGERON  
 Tél. : 01.69.52.47.00 - Fax : 01.69.52.47.01  
 e-mail : seguin@automatismes-seguin.fr  
 http://www.automatismes-seguin.fr

### TELECOMMANDE NIVEAUX

CLIENT ET NOM DU DOSSIER / CUSTOMER AND NAME OF FOLDER			INDICE / REVIEW
SAUR			0
Armoire Station Silo			 <small>VARS SERVICE PACK 4 - (4.843)</small>
DESSINATEUR / DRAWER	M.H.	FOLIO/SHEET 32 / 35	
N° AFFAIRE / N° PROJECT	180336		

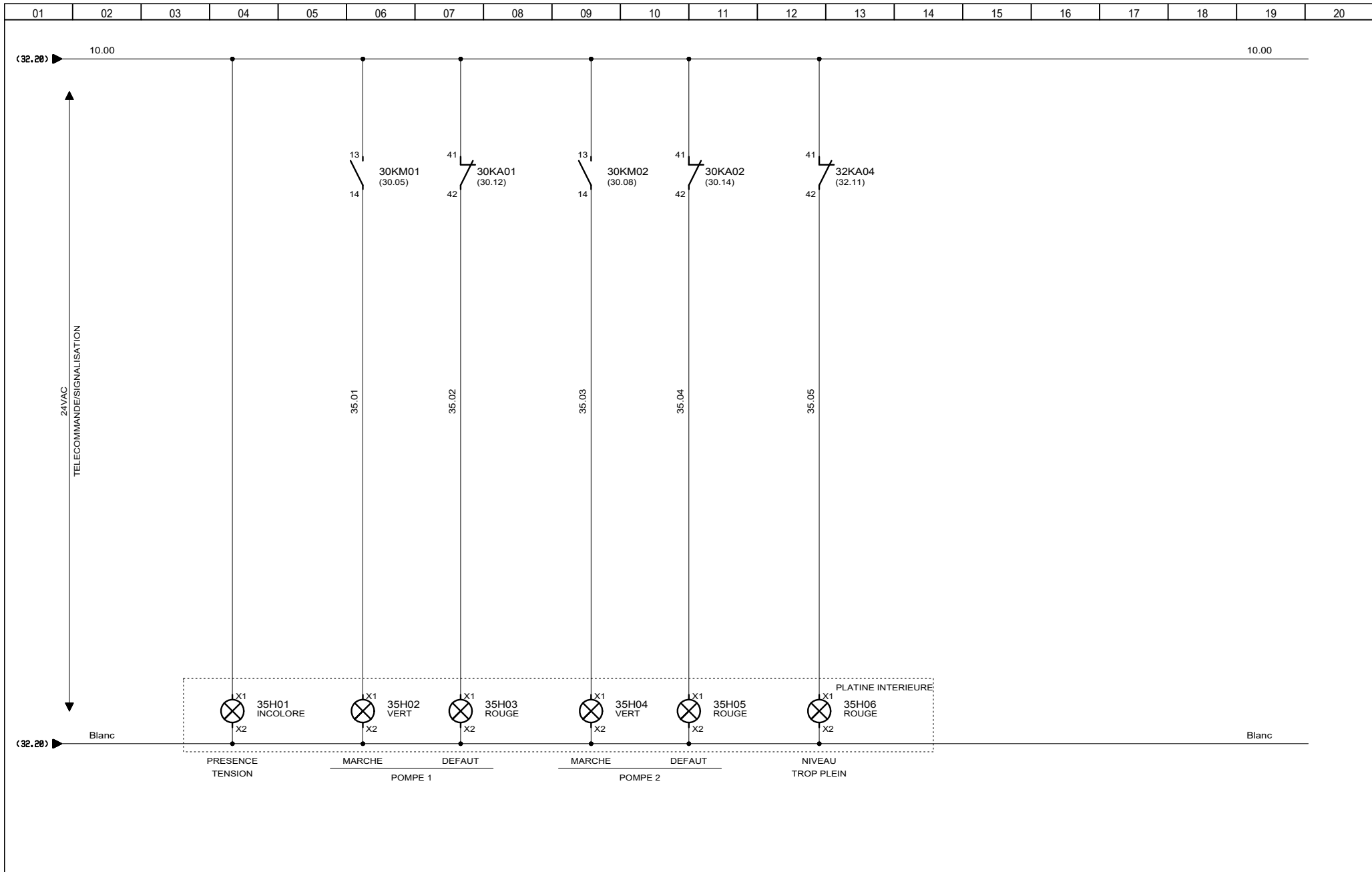

3, Rue Pierre Curie  
91230 MONTGERON  
Tél. : 01.69.52.47.00 - Fax : 01.69.52.47.01  
e-mail : seguin@automatismes-seguin.fr  
http://www.automatismes-seguin.fr

## SIGNALISATION

CLIENT ET NOM DU DOSSIER / CUSTOMER AND NAME OF FOLDER			INDICE / REVIEW
SAUR			0
Armoire Station Silo			 VARS SERVICE PACK 4 - (L84C)
DESSINATEUR / DRAWER	M.H.	FOLIO/SHEET 35 / 40	
N° AFFAIRE / N° PROJECT	180336		

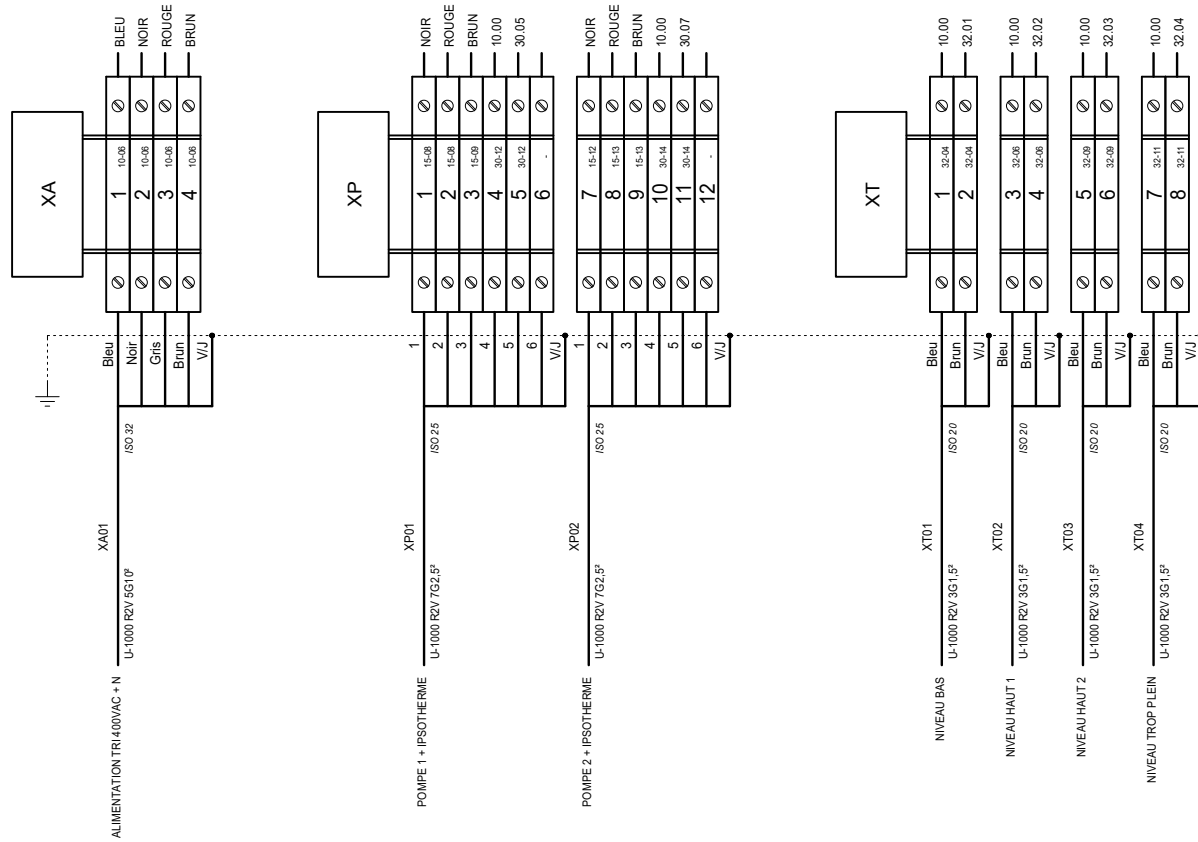

**BORNIERS**

**AUTOMATISMES SEGUIN**  
Systeme Qualité

3, Rue Pierre Curie  
91230 MONTGERON  
Tél. : 01.69.52.47.00 - Fax : 01.69.52.47.01  
e-mail : seguin@automatismes-seguin.fr  
http://www.automatismes-seguin.fr

CLIENT ET NOM DU DOSSIER / CUSTOMER AND NAME OF FOLDER		INDICE / REVIEW
SAUR Armoire Station Silo		0
DESSINATEUR DRAWER	M.H.	<b>IGE XAO</b>
N° AFFAIRE N° PROJECT	180336	
FOLIO/SHEET 40 / 50		VARS SERVICE PACK 4 - (A.84C)

REPERE	DESIGNATION	REFERENCE	MARQUE	QTE
TOLERIE	COFFRET UNIVERSEL AVEC PORTE PLEINE SANS CHASSIS 1000x800x300, IP66, RAL7035	NSYS3D10830	SCHNEIDER ELECTRIC	1
	POIGNEE A CLE 1242E	NSYAEDL1242S3D	SCHNEIDER ELECTRIC	1
	PORTE INTERNE POUR COFFRET H1000xL800	NSYPIN108	SCHNEIDER ELECTRIC	1
	SOCLE FRONTAL SF/SM 100x800	NSYSFP8100	SCHNEIDER ELECTRIC	1
	JEU DE 2 TRAPPES LATERALES SOCLE SD 100X300	NSYSP3100SD	SCHNEIDER ELECTRIC	1
	AUVENT POUR COFFRET L800xP300	NSYTJ8030	SCHNEIDER ELECTRIC	1
10E01	REPARTITEUR TETRAPOLAIRE TD 40 A, 12 CONNEXIONS	563740	ERICO	1
10E02	BARRETTE DE COUPURE BASSE, PLATINE PLASTIQUE 95x20mm, L = 125mm	034389	LEGRAND	1
10KA01	RELAIS INDUSTRIEL EMBROCHABLE, MONOSTABLE, 4INV, 24VAC + EMBASE + ETRIER	2903686 + 2900934 + 2900954	PHOENIX CONTACT	1
10PF01	RELAIS DE CONTROLE TRIPHASE POUR L'ORDRE ET LA PERTE DE PHASES, 208-480VAC, 1INV	DPA51CM44	CARLO GAVAZZI	1
10QD01	DISJONCTEUR IC60N 3P 1A, 440VAC/25kA, 133VDC/6kA, COURBE C	A9F74301	SCHNEIDER ELECTRIC	1
10QD02	DISJONCTEUR IC60N 2P 2A, 440VAC/25kA, 133VDC/6kA, COURBE C	A9F74202	SCHNEIDER ELECTRIC	1
10QD03	DISJONCTEUR DT40 1P+N 4A 6kA, COURBE C	A9N21022	SCHNEIDER ELECTRIC	1
10QIG01	INTERRUPTEUR DIFFERENTIEL IID TYPE AC 415VAC 4P 40A 300mA	A9R14440	SCHNEIDER ELECTRIC	1
10TR01	TRANSFORMATEUR DE COMMANDE ET DE SIGNALISATION MONOPHASEE 230-400V/24-48V, 100VA	044233	LEGRAND	1
12ECH01	RESISTANCE CHAUFFANTE PTC CS 060, 120-240V AC/DC, 50W	06000.0-00	STEGO	1
12ECL01	LAMPE LED 5W 220V 50-60Hz 500lm	NSYLAM5LD1	SCHNEIDER ELECTRIC	1
12KTH01	PETIT THERMOSTAT KTO 011, 1NF, 0..60°C	01146.9-00	STEGO	1
12QD01	DISJONCTEUR DT40 VIGI 1P+N CLASSE AC 16A 30mA COURBE C	A9N21444	SCHNEIDER ELECTRIC	1
12QD02	DISJONCTEUR DT40 1P+N 1A 6kA, COURBE C	A9N21019	SCHNEIDER ELECTRIC	1
12QD03	DISJONCTEUR DT40 1P+N 1A 6kA, COURBE C	A9N21019	SCHNEIDER ELECTRIC	1
12S01	INTERRUPTEUR DE POSITION 1NO+1NF RB, M12 POUSSOIR A GALET, 1m CABLE	XCMD21F2L1	SCHNEIDER ELECTRIC	1
12X01	PRISE DE COURANT 2P+T 10/16A, 250VAC A ECLIPS	004280	LEGRAND	1
15PA01	AMPEREMETRE ROTEX R72A90-A, 0-10A-50A DIRECT DEV. 90D	192D1301	SOCOMEK	1
	2 CAPUCHONS	192Z1016	SOCOMEK	1
15PA02	AMPEREMETRE ROTEX R72A90-A, 0-10A-50A DIRECT DEV. 90D	192D1301	SOCOMEK	1
	2 CAPUCHONS	192Z1016	SOCOMEK	1
15QD01	DISJONCTEUR MOTEUR MAGNETO-THERMIQUE 4-6.3A, BORNES A VIS	GV2ME10	SCHNEIDER ELECTRIC	1
	ADDITIF FRONTAL F+O	GVAE11	SCHNEIDER ELECTRIC	1
15QD02	DISJONCTEUR MOTEUR MAGNETO-THERMIQUE 4-6.3A, BORNES A VIS	GV2ME10	SCHNEIDER ELECTRIC	1
	ADDITIF FRONTAL F+O	GVAE11	SCHNEIDER ELECTRIC	1
20E01	RACK S530 5 EMBLEMENTS AVEC ALIM SECTEUR 230VAC	T9930A100	SOFREL	1
20E01-01	MODULE DE COMMUNICATION GSM/GPRS-3 + ANTENNE BI-BANDE	V5900540	SOFREL	1
20E01-03	MODULE D'ENTREES, 8E TOR	V5900210	SOFREL	1
20E01-04	MODULE D'ENTREES, 8E TOR	V5900210	SOFREL	1
20FP01	PROTECTION SECTEUR 230V, 5kA, Up=1.2kV	T5300011	SOFREL	1
20G01	BATTERIE 12V, 7Ah	NP7-12	YUASA	1
20QD01	DISJONCTEUR DT40 1P+N 4A 6kA, COURBE C	A9N21022	SCHNEIDER ELECTRIC	1
22S01	TETE BOUTON TOURNANT 2 POSITIONS A SERRURE AVEC CLE N°455	ZB4BG2	SCHNEIDER ELECTRIC	1
	CORPS CONTACT NO	ZB4BZ101	SCHNEIDER ELECTRIC	1
30KA01	RELAIS INDUSTRIEL EMBROCHABLE, MONOSTABLE, 4INV, 24VAC + EMBASE + ETRIER	2903686 + 2900934 + 2900954	PHOENIX CONTACT	1
30KA02	RELAIS INDUSTRIEL EMBROCHABLE, MONOSTABLE, 4INV, 24VAC + EMBASE + ETRIER	2903686 + 2900934 + 2900954	PHOENIX CONTACT	1
30KM01	CONTACTEUR DE PUISSANCE 9A 1NO+1NF 24V 50/60Hz	LC1D09B7	SCHNEIDER ELECTRIC	1
	BLOC DE CONTACTS AUXILIAIRES 2NO FRONTAL	LADN20	SCHNEIDER ELECTRIC	1
30KM02	CONTACTEUR DE PUISSANCE 9A 1NO+1NF 24V 50/60Hz	LC1D09B7	SCHNEIDER ELECTRIC	1
	BLOC DE CONTACTS AUXILIAIRES 2NO FRONTAL	LADN20	SCHNEIDER ELECTRIC	1
30PCH01	COMPTEUR HORAIRE TOTALISATEUR 10...30V, 50Hz	3220401071	KUBLER	1



3, Rue Pierre Curie  
91230 MONTGERON  
Tél. : 01.69.52.47.00 - Fax : 01.69.52.47.01  
e-mail : seguin@automatismes-seguin.fr  
http://www.automatismes-seguin.fr

NOMENCLATURE

CLIENT ET NOM DU DOSSIER / CUSTOMER AND NAME OF FOLDER			INDICE / REVIEW
SAUR			0
Armoire Station Silo			
DESSINATEUR DRAWER	M.H.	FOLIO/SHEET	50 / 51
N° AFFAIRE N° PROJECT	180336		
			IGE XAO VAR3 SERVICE PACK 4 - (4.84C)

