

22/01/2019	0	K.C.	RETOUR ESSAIS	F.C.	R.M.
20/12/2018	B	Q.D.	MISE A JOUR	F.C.	R.M.
10/12/2018	A	Q.D.	PREMIERE EMISSION	F.C.	R.M.
DATE	REV.	DESSINE PAR	MODIFICATIONS	VERIFIE PAR	APPROUVE PAR
DATE	REV.	DRAWN BY	REVISIONS	CHECKED BY	APPROVED BY

***SCHEMA ELECTRIQUE
ELECTRICAL DRAWING***



3, Rue Pierre Curie
91230 MONTGERON
Tél. : 01.69.52.47.00 - Fax : 01.69.52.47.01
e-mail : seguin@automatismes-seguin.fr
<http://www.automatismes-seguin.fr>

PLAN: 180441	REV: 0
CDE: 18134017YP00900	

Ce document est notre propriété. Il ne peut être reproduit et / ou communiqué sans autorisation.
This document is our property. It cannot be reproduced and / or transmitted without authorization.



Station Paroy

LETTRE DE REPERAGE DES ELEMENTS DU SCHEMA

QI	INTERRUPTEUR	PCPI	CONTROLEUR D'ISOLEMENT	KT	RELAIS TEMPORISE	SA	COMMUTATEUR D'AMPEREMETRE
QIG	INTERRUPTEUR GENERAL	TR	TRANSFORMATEUR DE TENSION	KAU	RELAIS ARRET D'URGENCE	SV	COMMUTATEUR DE VOLTMETRE
QD	DISJONCTEUR	TC	TRANSFORMATEUR DE COURANT	UF	VARIATEUR	ECH	RESISTANCE CHAUFFANTE
QDG	DISJONCTEUR GENERAL	U	ONDULEUR, ALIMENTATION	UM	DEMARREUR	ECL	ECLAIRAGE
FP	PARAFODRE	KIC	INTER CREPUSCULAIRE	S	ORGANE DE COMMANDE	G	BATTERIE
FU	FUSIBLE	KIH	HORLOGE	H	VOYANT, SIRENE	P	INSTRUMENTATION
F	THERMIQUE	KTH	THERMOSTAT	PCH	COMPTEUR HORAIRE	X	PRISE DE COURANT, BORNIER
QF	SECTIONNEUR FUSIBLE	KM	CONTACTEUR	PA	AMPEREMETRE	E	MATERIELS AUTRES
PF	CONTROLEUR DE PHASE	KA	RELAIS	PV	VOLTMETRE	KTL	TELERUPTEUR

LETTER CODES FOR ITEMS DESIGNATION ON THE DRAWING

QI	SWITCH	PCPI	INSULATION CONTROLLER	KT	TEMPORIZES RELAY	SA	AMPEREMETER SWITCH
QIG	GENERAL SWITCH	TR	TENSION TRANSFORMER	KAU	EMERGENCY STOP RELAY	SV	VOLTMETER SWITCH
QD	BREAKER	TC	CURRENT TRANSFORMER	UF	VELOCITY VARIATOR	ECL	LIGHT
QDG	GENERAL BREAKER	U	INVERTER, SUPPLY	UM	MOTOR STARTER	ECH	HEATER
FP	LIGHTNING PROTECTOR	KIC	DIMMER	S	CONTROL UNIT	G	BATTERY
FU	FUSE	KIH	CLOCK	H	INDICATOR	P	INSTRUMENTATION
F	THERMAL RELAY	KTH	THERMOSTAT	PCH	TIMER	X	SOCKET, TERMINAL BLOCK
QF	DISCONNECTING SWITCH	KM	CONTACTOR	PA	AMPEREMETER	E	OTHER EQUIPMENTS
PF	PHASE CONTROLLER	KA	RELAY	PV	VOLTMETER	KTL	TELEBREAKER

COULEURS DE FILS

TRI 400V: <= 6 mm2 Noir Rouge Brun
> 6 mm2 Noir Bagué Noir Rouge Brun

NEUTRE: Bleu Clair

230VAC: Rouge avec Commun Bobines Blanc (*)

230VAC ONDULE: Neutre Bleu Clair Bagué Orange
Phase Noir Bagué Orange

110VAC: Noir avec Commun Bobines Blanc (*)

24VAC: Violet avec Commun Bobines Blanc (*)

24VDC: Bleu Foncé avec Commun Bobines Blanc (*)

48VAC: Violet avec Commun Bobines Blanc (*)

48VDC: Bleu Foncé avec Commun Bobines Blanc (*)

REPORTS: Orange

TERRE: Vert/Jaune

ANALOGIQUE: Une Paire + Brun - Blanc
Unifilaire Blanc

TENSION EXTERNE PERMANENTE INTER GENERAL OUVERT: Orange

ATTENTION

Si plusieurs tensions de télécommande, alors prendre uniquement le 230VAC avec Commun Bobines Blanc

(*) Si Télécommande

WIRE COLOR

TRI 400V: <= 6 mm2 Black Red Brown
> 6 mm2 Black with Ring Black Red Brown

NEUTRE: Light Blue

230VAC: Red with Spods Common White (*)

230VAC UPS: Neutre Light Blue with Ring Orange
Phase Black with Ring Orange

110VAC: Black with Spods Common White (*)

24VAC: Purple with Spods Common White (*)

24VDC: Dark Bleu with Spods Common White (*)

48VAC: Purple with Spods Common White (*)

48VDC: Dark Bleu with Spods Common White (*)

REPORTS: Orange

GROUND: Green/Yellow

ANALOGICAL: One Pair + Brown - White
Unifilar White

PERMANENTLY EXTERNAL POWER GENERAL BREAKER OPEN: Orange

CAUTION

If There are Several Tensions of Command Then to take Only the 230VAC with Spods Common White

(*) If Command

TYPE DE RELAIS ET DE CONTACT DANS LE SCHEMA

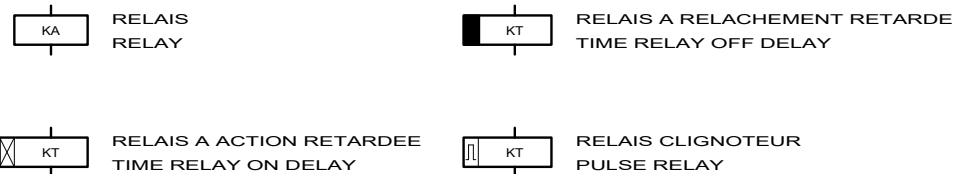

RELAY AND CONTACT TYPE IN THE DRAWING

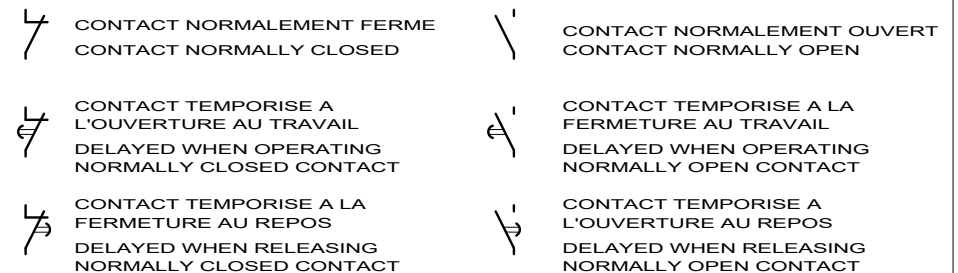

LE SCHEMA EST REPRESENTE HORS TENSION ET GENERATEUR HORS SERVICE

THE DRAWING IS SHOWN OUT OF VOLTAGE AND WITH GENERATOR OUT OF SERVICE



3, Rue Pierre Curie
91230 MONTGERON
Tél. : 01.69.52.47.00 - Fax : 01.69.52.47.01
e-mail : seguin@automatismes-seguin.fr
http://www.automatismes-seguin.fr

LEGENDE DU SCHEMA ELECTRIQUE

CLIENT ET NOM DU DOSSIER / CUSTOMER AND NAME OF FOLDER			INDICE / REVIEW
SAUR Station Paroy			0
DESSINATEUR DRAWER	Q.D.	FOLIO/SHEET	03 / 04
N° AFFAIRE N° PROJECT	180441		
			IGE-XAO VARS SERVICE PACK 4 - (L84C)

CODE DU REPERAGE

LETTER CODE

1/ DES APPAREILS DANS LES ARMOIRES
APPARATUS IN THE CABINETS

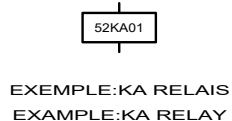

52 KA 01

N° D'ORDRE DANS LE FOLIO D'ORIGINE
ORDER NUMBER ON ORIGINAL SHEET

LETTRE DE REPERAGE
LETTER CODES FOR ITEM

N° DU FOLIO D'ORIGINE
ORIGINAL SHEET NUMBER

2/ DES FILS DE CABLAGE
WIRING

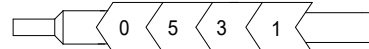

N° DU FOLIO D'ORIGINE
ORIGINAL SHEET NUMBER

N° DU FIL DANS LE FOLIO D'ORIGINE
NUMBER OF THE WIRE ON ORIGINAL SHEET

3/ REPORT DES CONTACTS DANS LE SCHEMA
CONTACT REPORT IN THE DRAWING

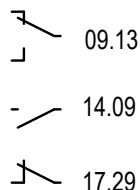

17.29

N° DE LA COLONNE OU EST UTILISE LE CONTACT
COLUMN NUMBER WHERE THE CONTACT IS USED

N° DU FOLIO OU EST UTILISE LE CONTACT
SHEET NUMBER WHERE THE CONTACT IS USED

4/ REPRESENTATION DES BORNES ET BORNIERES DANS LE SCHEMA
BINDINGS SCREWS VIEW IN THE DRAWING

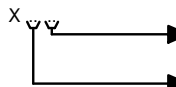

N° D'ORDRE (SI NECESSAIRE)
ORDER NUMBER (IF NECESSARY)

NATURE DU BORNIER
NATURE OF TERMINAL BLOCK

- A : ALIMENTATION
- P : PUISSANCE
- T : TELECOMMANDE
- M : MESURE
- R : REPORTS



LE SCHEMA EST REPRESENTE HORS TENSION ET GENERATEUR HORS SERVICE

THE DRAWING IS SHOWN OUT OF VOLTAGE AND WITH GENERATOR OUT OF SERVICE



3, Rue Pierre Curie
91230 MONTGERON
Tél. : 01.69.52.47.00 - Fax : 01.69.52.47.01
e-mail : seguin@automatismes-seguin.fr
http://www.automatismes-seguin.fr

LEGENDE DU SCHEMA ELECTRIQUE

CLIENT ET NOM DU DOSSIER / CUSTOMER AND NAME OF FOLDER		INDICE / REVIEW
SAUR Station Paroy		0
DESSINATEUR DRAWER	Q.D.	FOLIO/SHEET 04/05
N° AFFAIRE N° PROJECT	180441	
		IGE-XAO VAR3 SERVICE PACK 4 - (L84C)

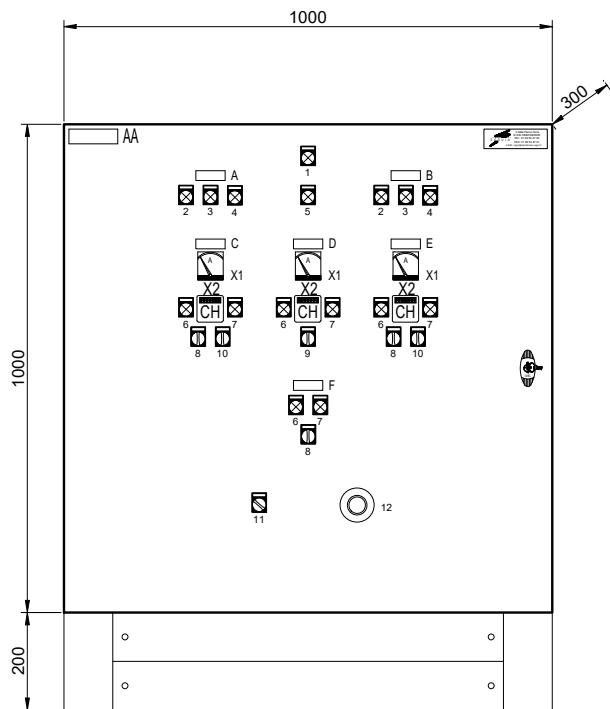

FACADE

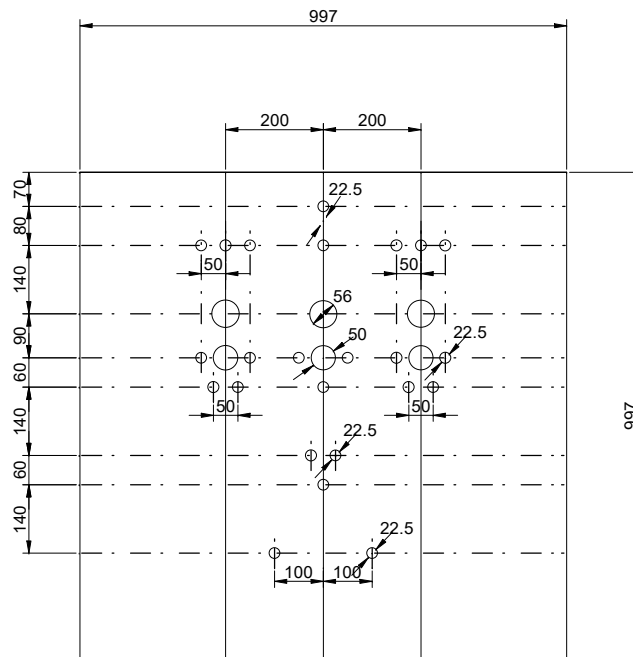

PLAN DE DECOUPE

ETIQUETTES 100x30

AA - ARMOIRE STATION PAROY

ETIQUETTES 60x20

- A - RESERVOIR LES CHOLLETS
- B - RESERVOIR PUIITS DE GY
- C - POMPE LES CHOLLETS
- D - POMPE SECOURS
- E - POMPE PUIITS DE GY
- F - ELECTROVANNE STERILISATION

ETIQUETTES SCHNEIDER

- 1 - SOUS TENSION
- 2 - NIVEAU BAS
- 3 - NIVEAU MOYEN
- 4 - NIVEAU HAUT
- 5 - MANQUE D'EAU
- 6 - MARCHÉ
- 7 - DEFAUT
- 8 - AUTO / 0 / MAIN
- 9 - P1 / 0 / P2
- 10 - HORLOGE / HORLOGE+NIVEAUX / NIVEAUX
- 11 - HIVER / ETE
- 12 - COUPURE D'URGENCE

DIVERS

- X1 - AMPEREMETRE
- X2 - COMPTEUR HORAIRE



3, Rue Pierre Curie
91230 MONTGERON
Tél. : 01.69.52.47.00 - Fax : 01.69.52.47.01
e-mail : seguin@automatismes-seguin.fr
http://www.automatismes-seguin.fr

IMPLANTATION EXTERNE

CLIENT ET NOM DU DOSSIER / CUSTOMER AND NAME OF FOLDER		INDICE / REVIEW
SAUR Station Paroy		0
DESSINATEUR DRAWER	Q.D.	FOLIO/SHEET 05 / 10
N° AFFAIRE N° PROJECT	180441	
		IGE-XAO VAR3 SERVICE PACK 4 - (4.843)

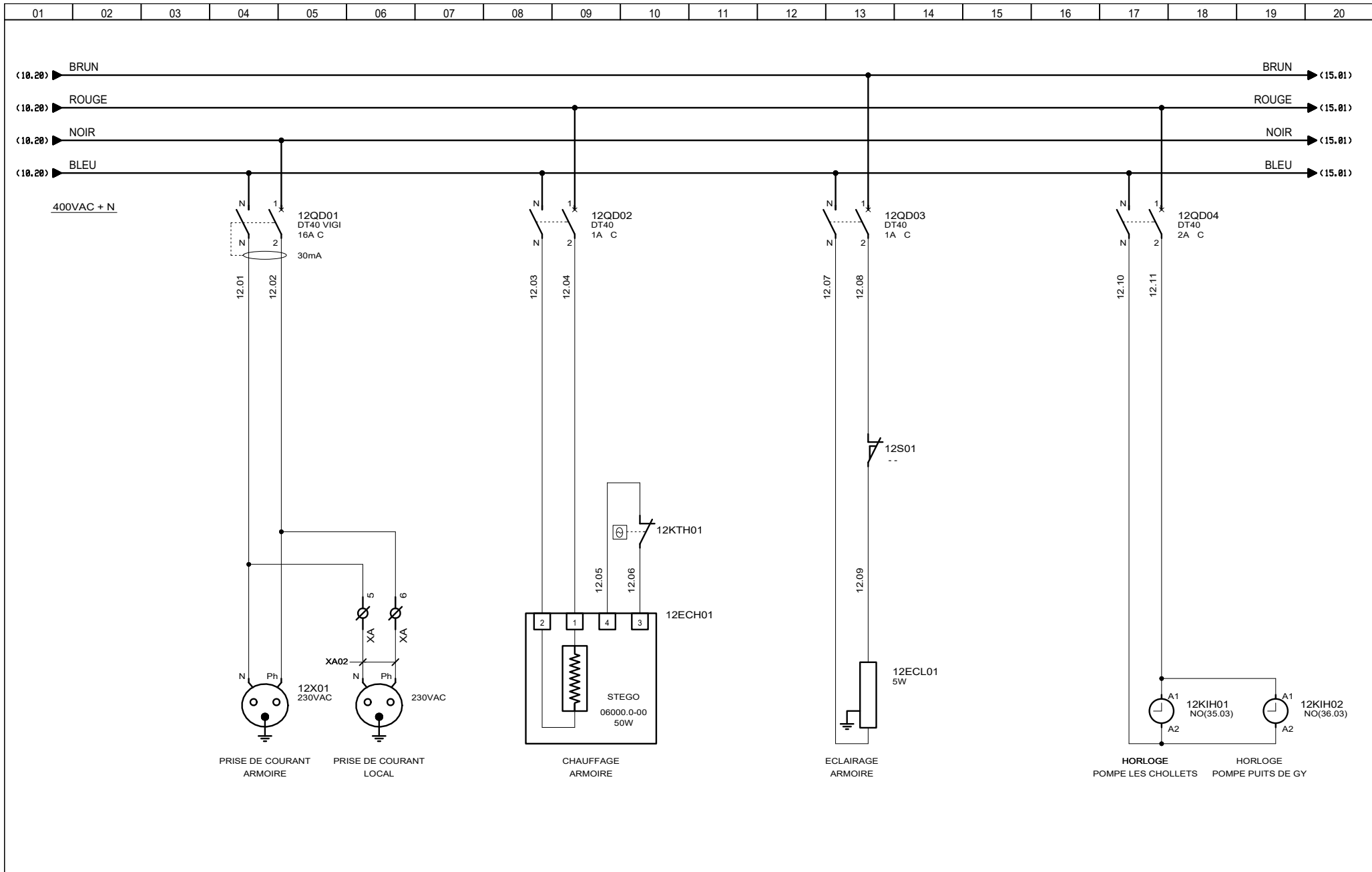

3, Rue Pierre Curie
91230 MONTGERON
Tél. : 01.69.52.47.00 - Fax : 01.69.52.47.01
e-mail : seguin@automatismes-seguin.fr
http://www.automatismes-seguin.fr

DISTRIBUTION 400VAC + N UTILITES

CLIENT ET NOM DU DOSSIER / CUSTOMER AND NAME OF FOLDER		INDICE / REVIEW
SAUR Station Paroy		0
DESSINATEUR DRAWER	Q.D.	
N° AFFAIRE N° PROJECT	180441	
FOLIO/SHEET 12 / 15		VAR3 SERVICE PACK 4 - (4.843)

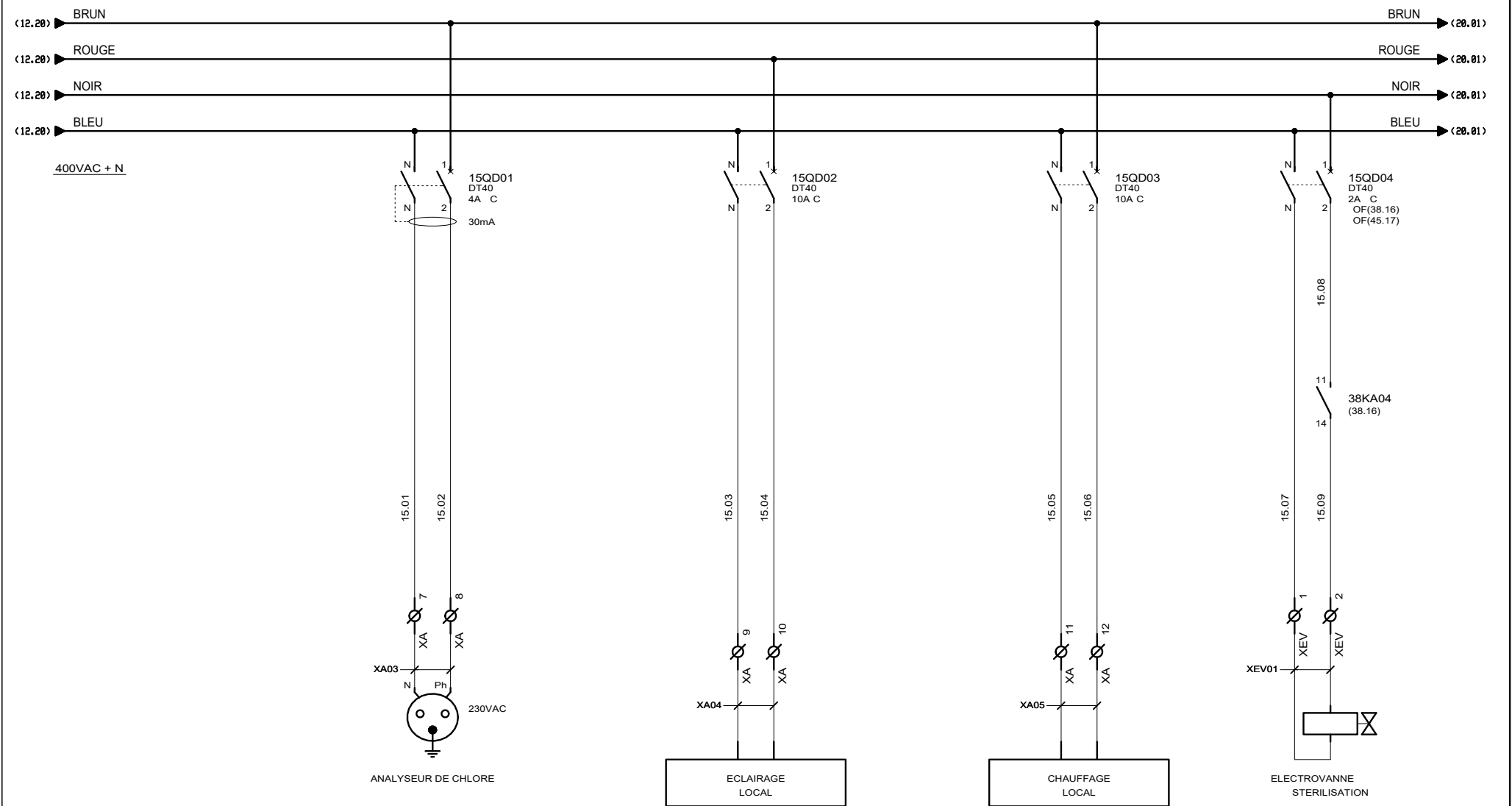

 3, Rue Pierre Curie
 91230 MONTGERON
 Tél. : 01.69.52.47.00 - Fax : 01.69.52.47.01
 e-mail : seguin@automatismes-seguin.fr
 http://www.automatismes-seguin.fr

DISTRIBUTION 400VAC + N LOCAL

CLIENT ET NOM DU DOSSIER / CUSTOMER AND NAME OF FOLDER		INDICE / REVIEW
SAUR Station Paroy		0
DESSINATEUR DRAWER	Q.D.	FOLIO/SHEET 15 / 20
N° AFFAIRE N° PROJECT	180441	
		IGE-XAO VAR3 SERVICE PACK 4 - (4.84C)

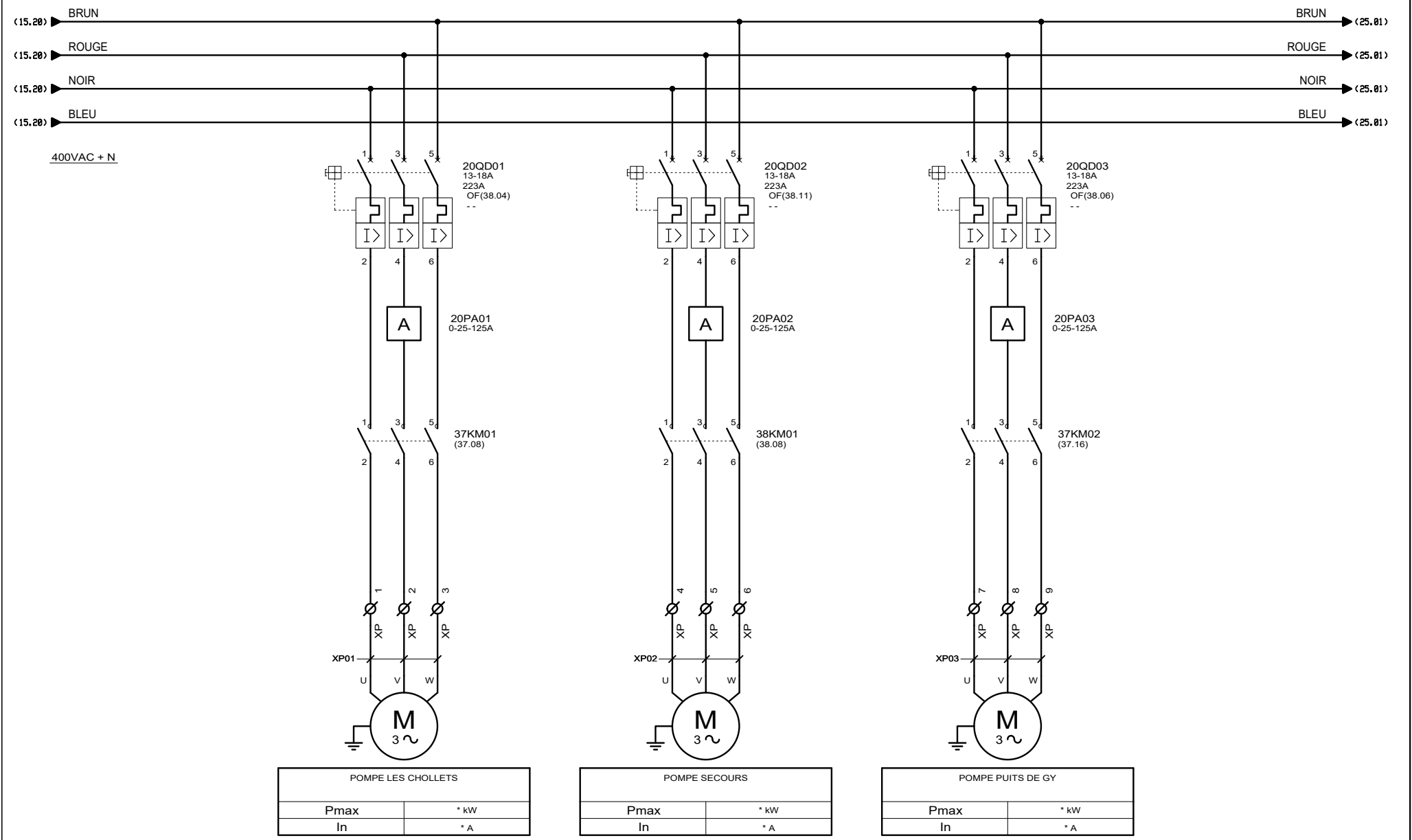

AUTOMATISMES SEGUIN
 Systeme Qualité

3, Rue Pierre Curie
 91230 MONTGERON
 Tél. : 01.69.52.47.00 - Fax : 01.69.52.47.01
 e-mail : seguin@automatismes-seguin.fr
 http://www.automatismes-seguin.fr

PUISSANCE POMPES

CLIENT ET NOM DU DOSSIER / CUSTOMER AND NAME OF FOLDER		INDICE / REVIEW
SAUR Station Paroy		0
DESSINATEUR DRAWER	Q.D.	FOLIO/SHEET 20 / 25
N° AFFAIRE N° PROJECT	180441	
VARS SERVICE PACK 4 - (4.84)		

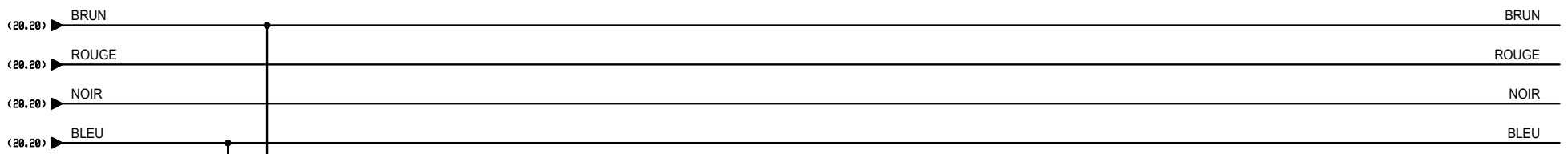

SOFREL S550 (VUE DE DESSOUS)

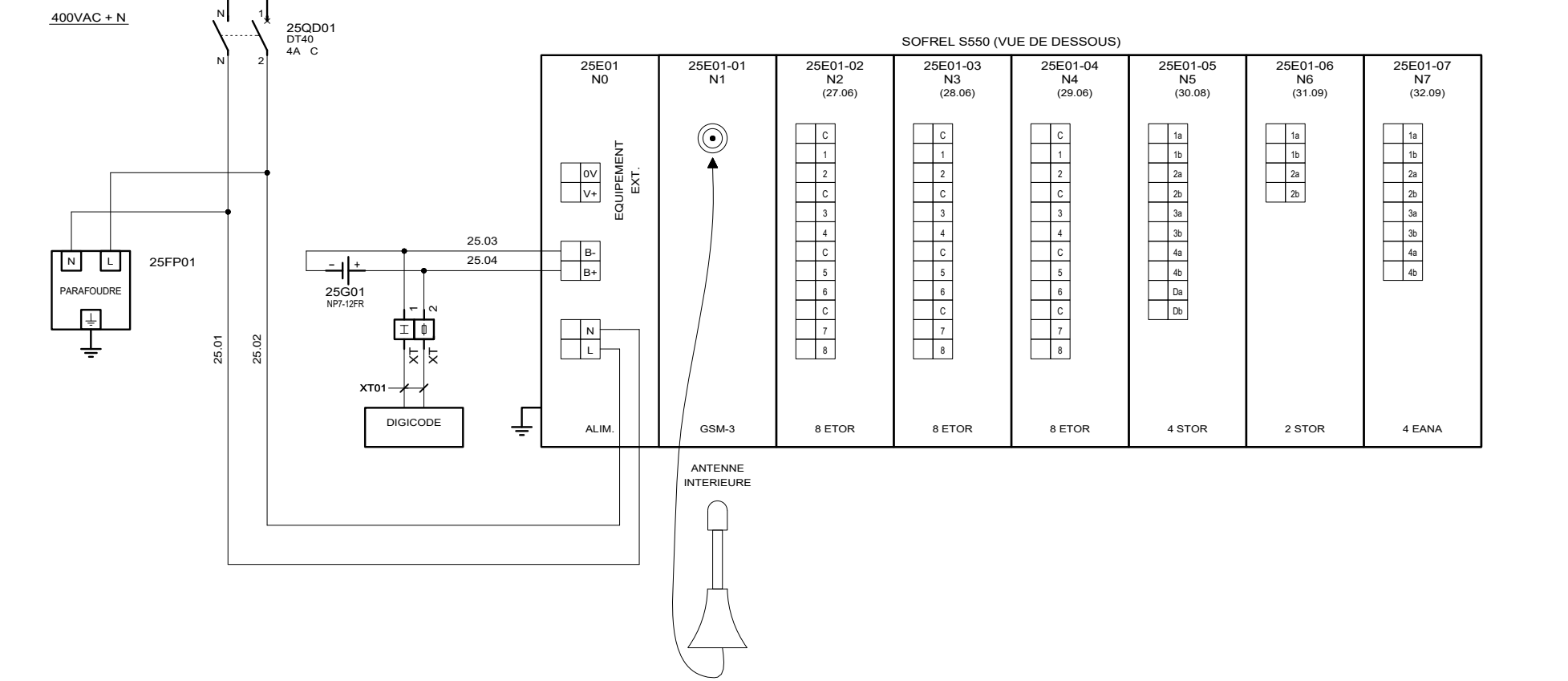

AUTOMATISMES SEGUIN
3, Rue Pierre Curie
91230 MONTGERON
Tél. : 01.69.52.47.00 - Fax : 01.69.52.47.01
e-mail : seguin@automatismes-seguin.fr
http://www.automatismes-seguin.fr

ALIMENTATION SOFREL S550

CLIENT ET NOM DU DOSSIER / CUSTOMER AND NAME OF FOLDER		INDICE / REVIEW
SAUR Station Paroy		0
DESSINATEUR DRAWER	Q.D.	IGE XAO
N° AFFAIRE N° PROJECT	180441	
FOLIO/SHEET 25 / 27		VARS SERVICE PACK 4 - (4.84C)

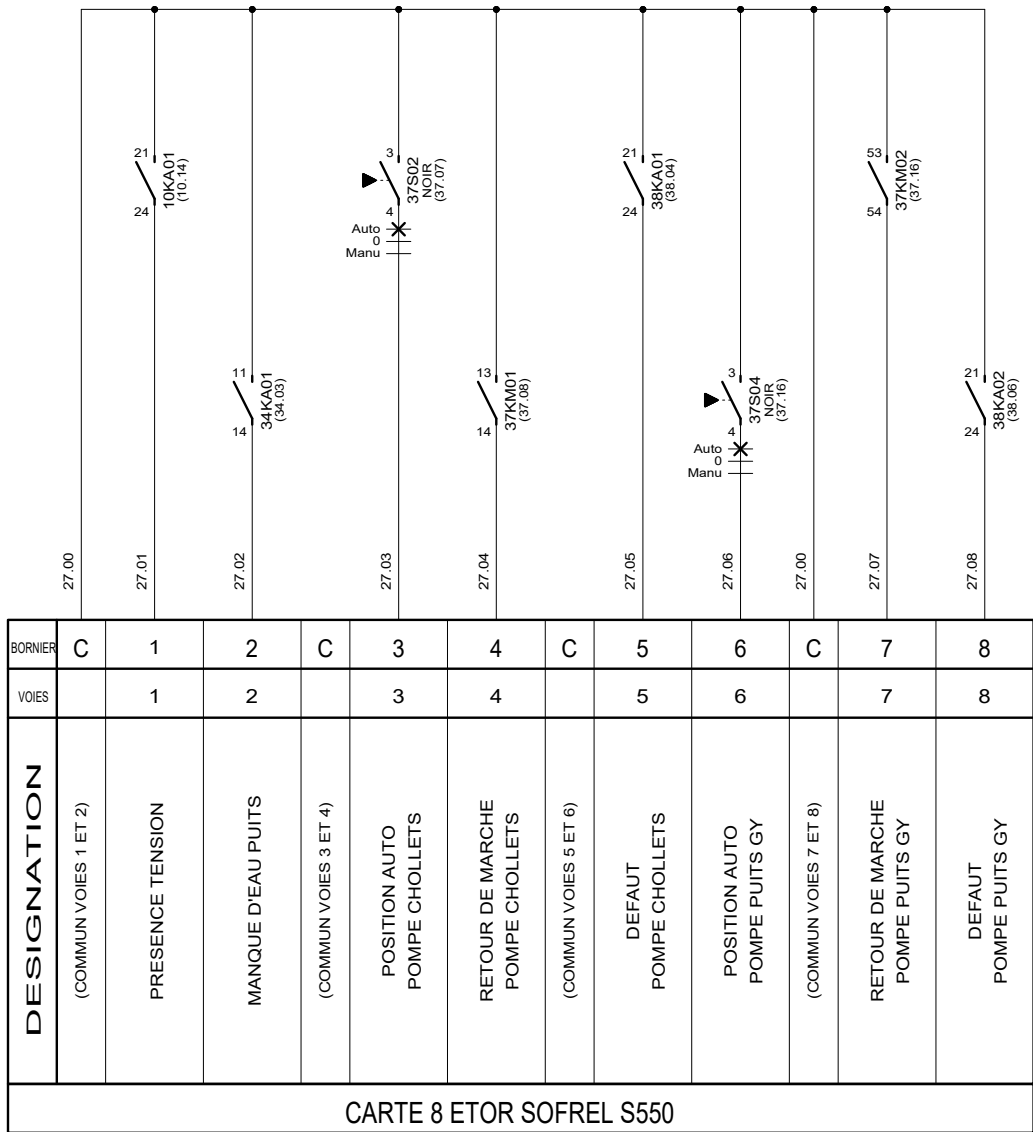

25E01-02
(25.10)

**CARTE 8 ENTrees TOR
EMPLACEMENT 2**

CLIENT ET NOM DU DOSSIER / CUSTOMER AND NAME OF FOLDER		INDICE / REVIEW
SAUR Station Paroy		0
DESSINATEUR DRAWER	Q.D.	FOLIO/SHEET 27 / 28
N° AFFAIRE N° PROJECT	180441	
		VARS SERVICE PACK 4 - (A.84C)

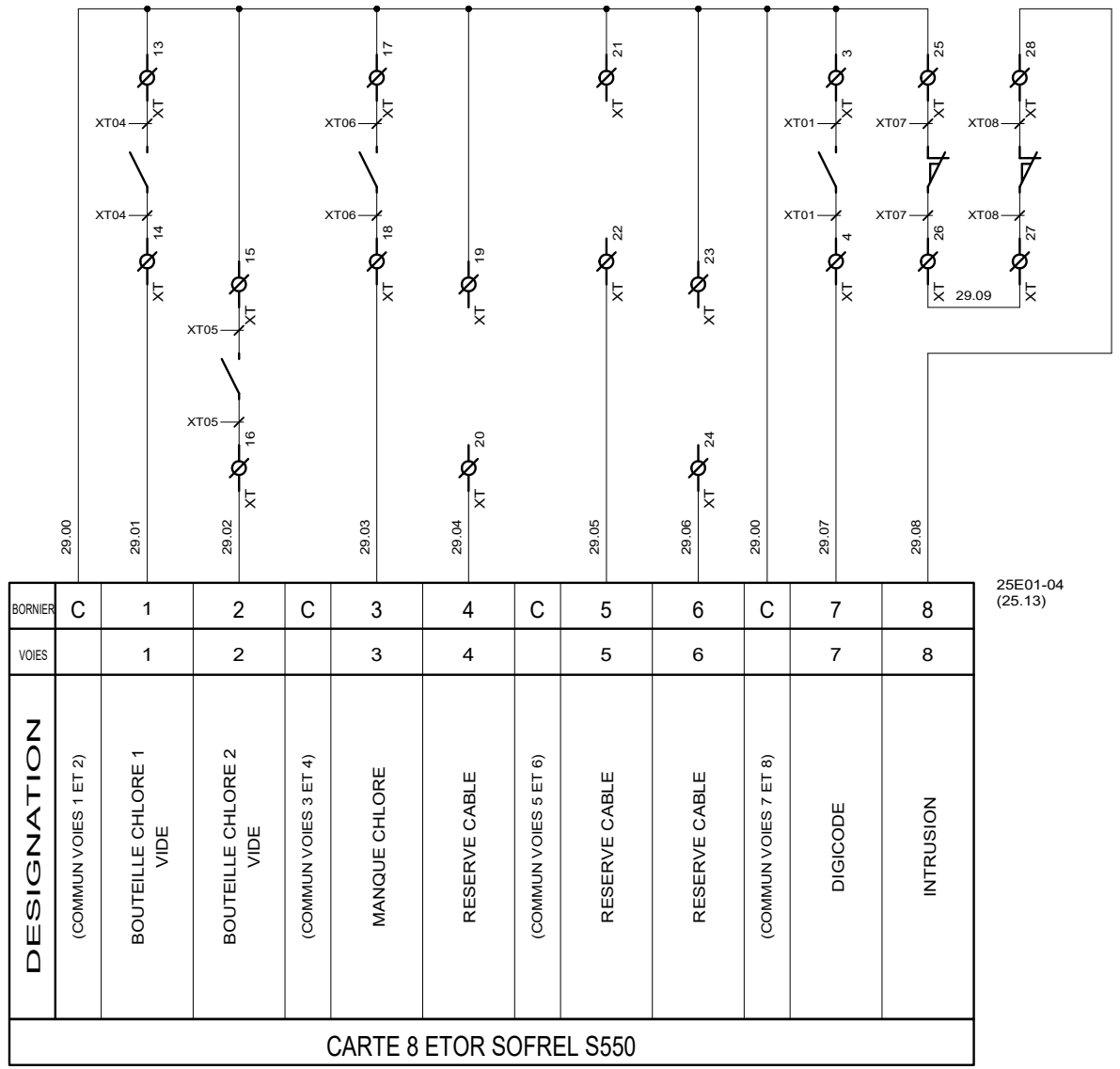

BORNIER	C	1	2	C	3	4	C	5	6	C	7	8	
VOIES		1	2		3	4		5	6		7	8	
DESIGNATION		(COMMUN VOIES 1 ET 2)	BOUTEILLE CHLORE 1 VIDE	BOUTEILLE CHLORE 2 VIDE	(COMMUN VOIES 3 ET 4)	MANQUE CHLORE	RESERVE CABLE	(COMMUN VOIES 5 ET 6)	RESERVE CABLE	RESERVE CABLE	(COMMUN VOIES 7 ET 8)	DIGICODE	INTRUSION
CARTE 8 ETOR SOFREL S550													

25E01-04
(25.13)



3, Rue Pierre Curie
91230 MONTGERON
Tél. : 01.69.52.47.00 - Fax : 01.69.52.47.01
e-mail : seguin@automatismes-seguin.fr
http://www.automatismes-seguin.fr

**CARTE 8 ENTRES TOR
EMPLACEMENT 4**

CLIENT ET NOM DU DOSSIER / CUSTOMER AND NAME OF FOLDER		INDICE / REVIEW
SAUR Station Paroy		0
DESSINATEUR DRAWER	Q.D.	FOLIO/SHEET 29 / 30
N° AFFAIRE N° PROJECT	180441	
		VARS SERVICE PACK 4 - (A.84C)

CARTE 4 STOR-wdg SOFREL S550										
DESIGNATION	NIVEAU BAS CHOLLETS		NIVEAU HAUT CHOLLETS		NIVEAU BAS GY		NIVEAU HAUT GY			
	1		2		3		4		5	
BORNIER	1a	1b	2a	2b	3a	3b	4a	4b	Da	Db

25E01-05
(25.14)

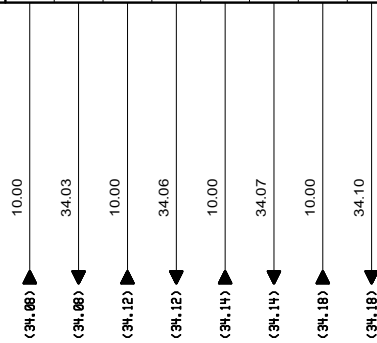

3, Rue Pierre Curie
91230 MONTGERON
Tél. : 01.69.52.47.00 - Fax : 01.69.52.47.01
e-mail : seguin@automatismes-seguin.fr
http://www.automatismes-seguin.fr

**CARTE 4 SORTIES TOR
EMPLACEMENT 5**

CLIENT ET NOM DU DOSSIER / CUSTOMER AND NAME OF FOLDER			INDICE / REVIEW
SAUR Station Paroy			0
DESSINATEUR DRAWER	Q.D.	FOLIO/SHEET	30 / 31
N° AFFAIRE N° PROJECT	180441	IGE XAO VAR3 SERVICE PACK 4 - (4.84)	

CARTE 2 STORSOFREL S550				
DESIGNATION	ARRET POMPAGE		RESERVE CABLE	
	1		2	
	1a	1b	2a	2b

25E01-06
(25.16)

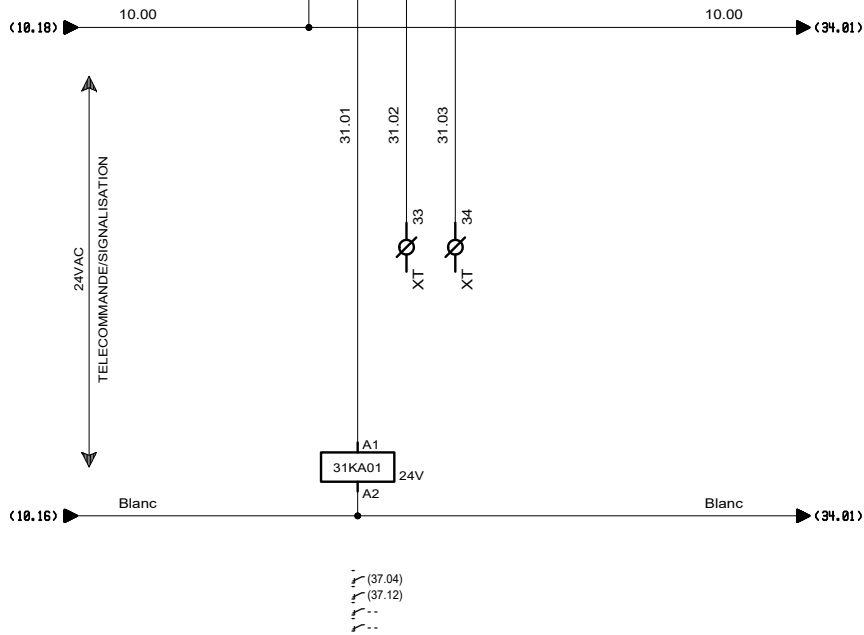

3, Rue Pierre Curie
91230 MONTGERON
Tél. : 01.69.52.47.00 - Fax : 01.69.52.47.01
e-mail : seguin@automatismes-seguin.fr
http://www.automatismes-seguin.fr

CARTE 2 SORTIES TOR
EMPLACEMENT 6

CLIENT ET NOM DU DOSSIER / CUSTOMER AND NAME OF FOLDER			INDICE / REVIEW
SAUR Station Paroy			0
DESSINATEUR DRAWER	Q.D.	FOLIO/SHEET	31/32
N° AFFAIRE N° PROJECT	180441	VARS SERVICE PACK 4 - (4.84)	

RACCORDEMENT :
POUR CAPTEUR AUTONOME



RACCORDEMENT :
POUR CAPTEUR TELEALIMENTE

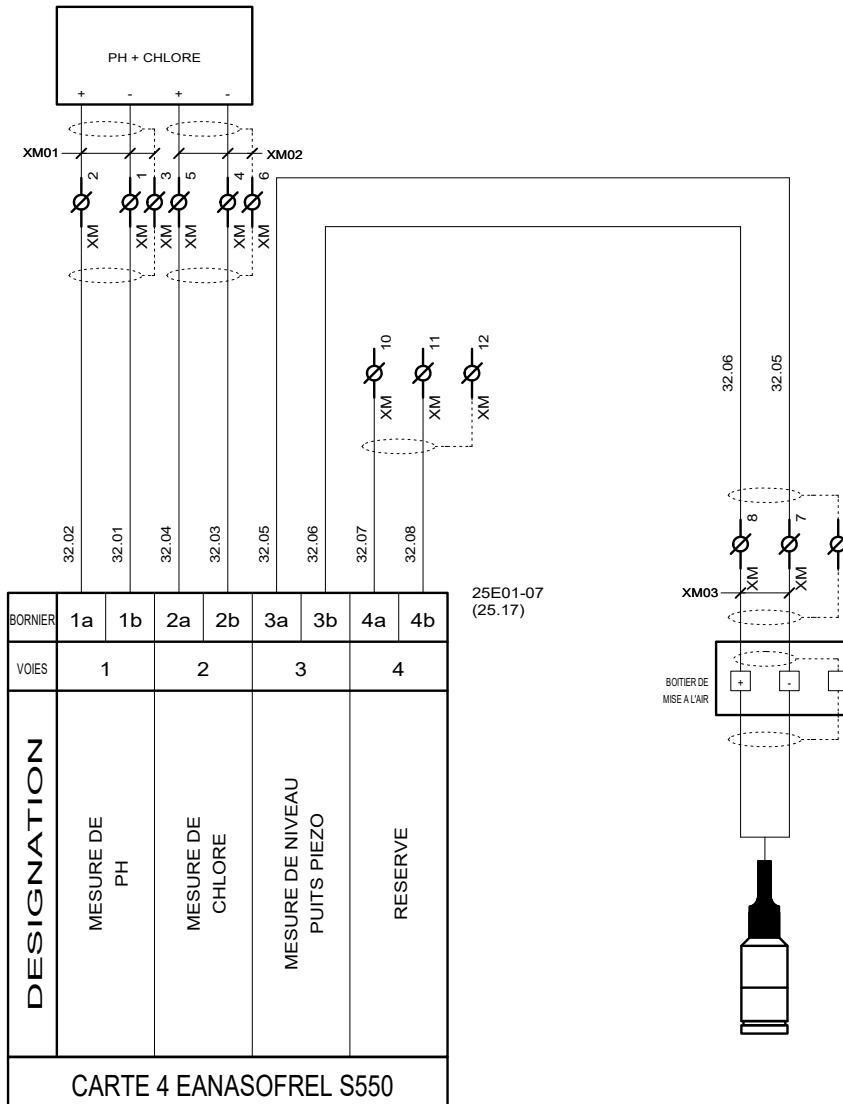
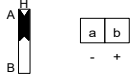

3, Rue Pierre Curie
91230 MONTGERON
Tél. : 01.69.52.47.00 - Fax : 01.69.52.47.01
e-mail : seguin@automatismes-seguin.fr
http://www.automatismes-seguin.fr

CARTE 4 ENTREES ANALOGIQUES
EMPLACEMENT 7

CLIENT ET NOM DU DOSSIER / CUSTOMER AND NAME OF FOLDER		INDICE / REVIEW
SAUR Station Paroy		0
DESSINATEUR DRAWER	Q.D.	FOLIO/SHEET 32 / 34
N° AFFAIRE N° PROJECT	180441	
		IGE-XAO VAR3 SERVICE PACK 4 - (4.84C)

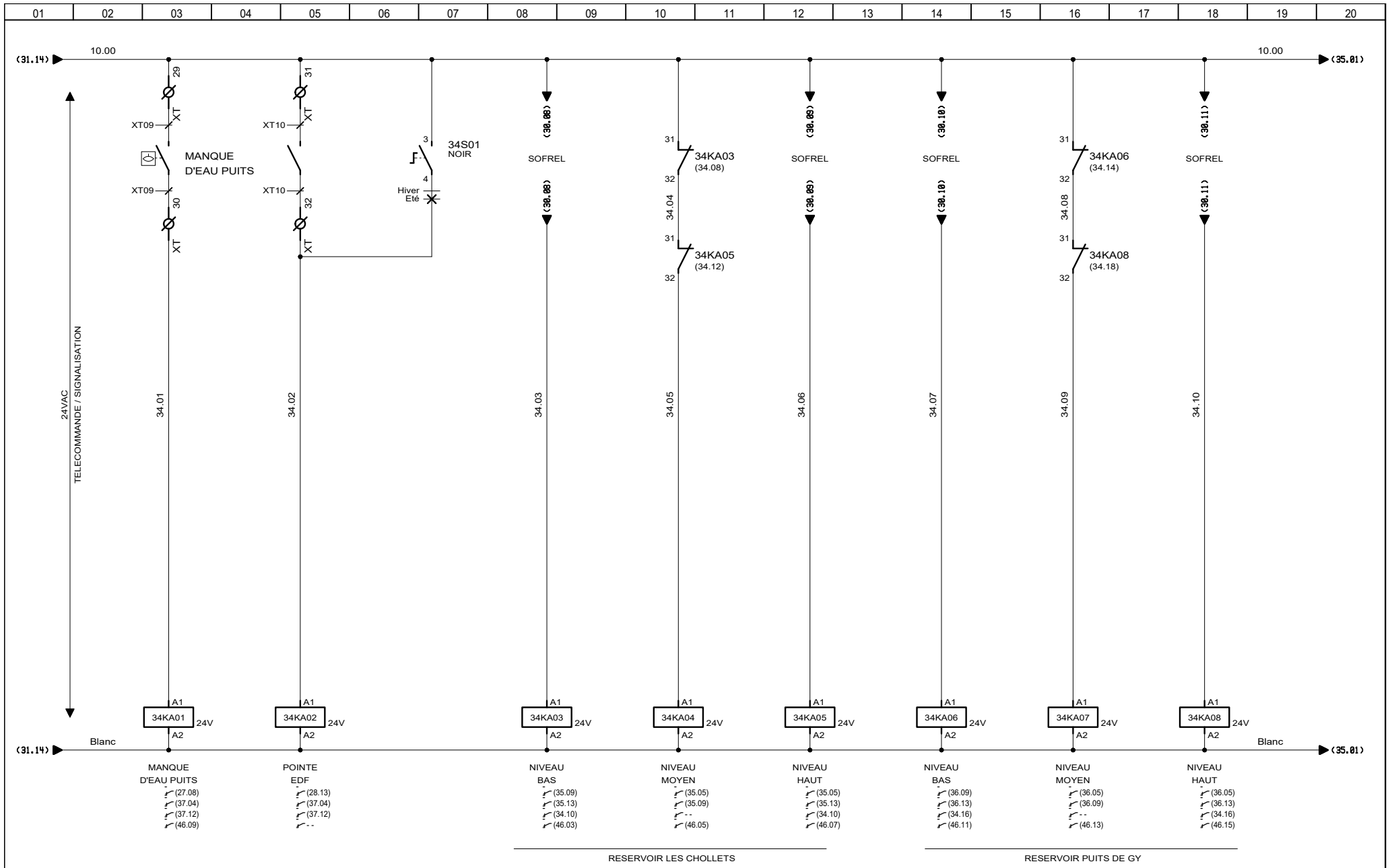

3, Rue Pierre Curie
 91230 MONTGERON
 Tél. : 01.69.52.47.00 - Fax : 01.69.52.47.01
 e-mail : seguin@automatismes-seguin.fr
 http://www.automatismes-seguin.fr

TELECOMMANDE

CLIENT ET NOM DU DOSSIER / CUSTOMER AND NAME OF FOLDER		INDICE / REVIEW
SAUR Station Paroy		0
DESSINATEUR DRAWER	Q.D.	IGE XAO
N° AFFAIRE N° PROJECT	180441	
FOLIO/SHEET 34 / 35		VAR3 SERVICE PACK 4 - (L84C)

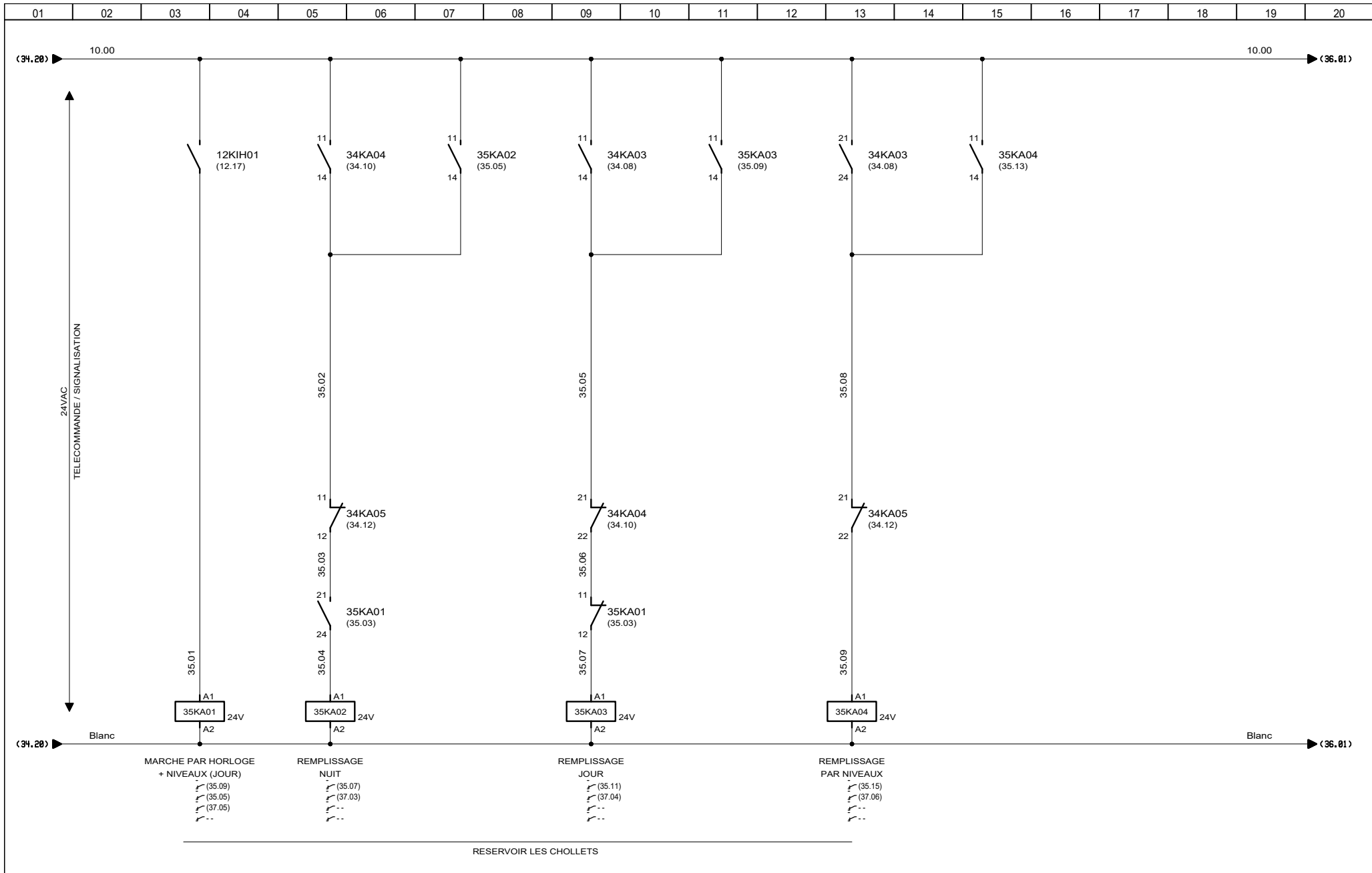

3, Rue Pierre Curie
91230 MONTGERON
Tél. : 01.69.52.47.00 - Fax : 01.69.52.47.01
e-mail : seguin@automatismes-seguin.fr
http://www.automatismes-seguin.fr

TELECOMMANDE

CLIENT ET NOM DU DOSSIER / CUSTOMER AND NAME OF FOLDER		INDICE / REVIEW
SAUR Station Paroy		0
DESSINATEUR DRAWER	Q.D.	FOLIO/SHEET 35 / 36
N° AFFAIRE N° PROJECT	180441	
		IGE XAO VAR3 SERVICE PACK 4 - (L84C)

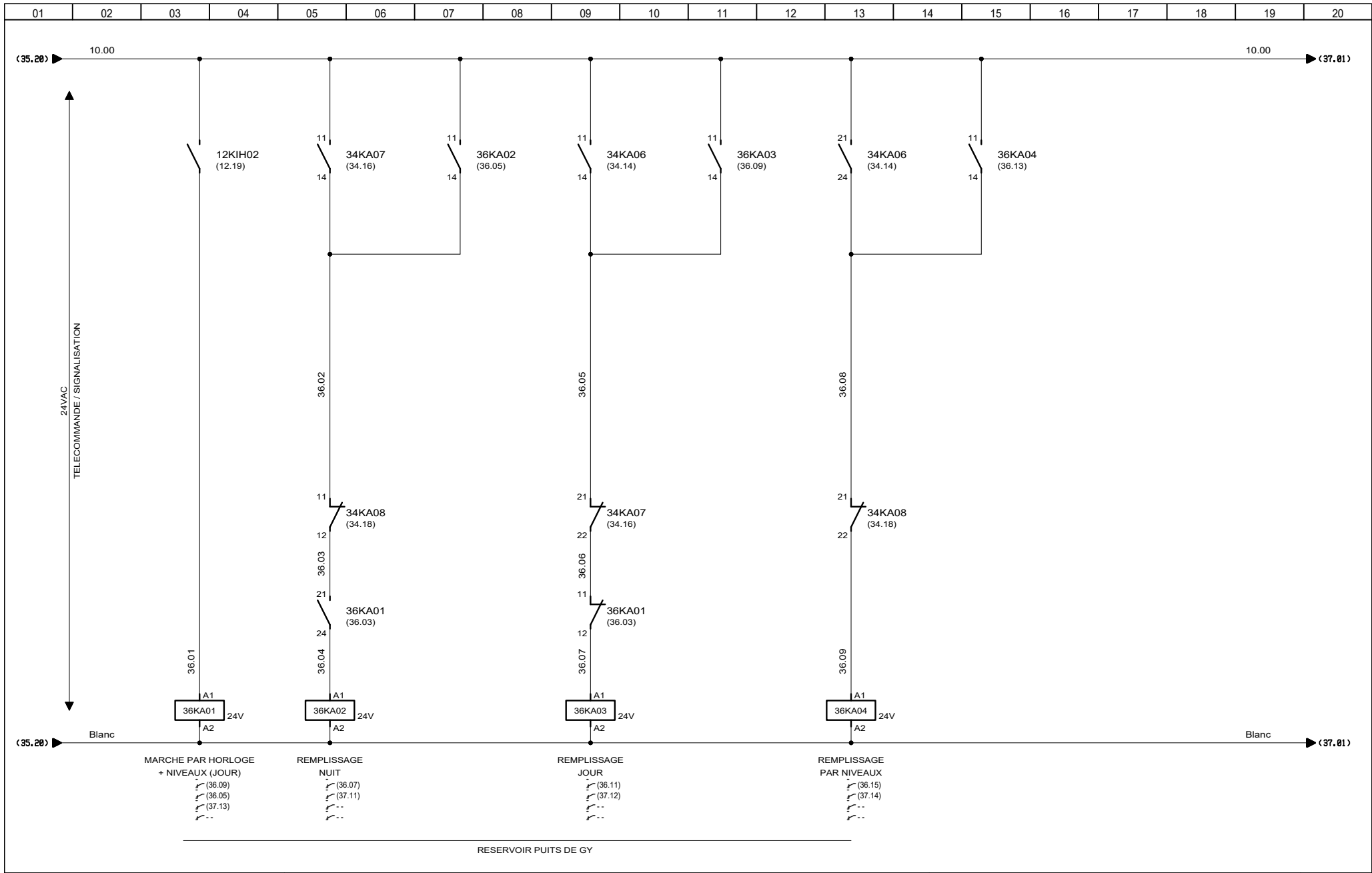

3, Rue Pierre Curie
91230 MONTGERON
Tél. : 01.69.52.47.00 - Fax : 01.69.52.47.01
e-mail : seguin@automatismes-seguin.fr
http://www.automatismes-seguin.fr

TELECOMMANDE

CLIENT ET NOM DU DOSSIER / CUSTOMER AND NAME OF FOLDER		INDICE / REVIEW
SAUR Station Paroy		0
DESSINATEUR DRAWER	Q.D.	FOLIO/SHEET 36 / 37
N° AFFAIRE N° PROJECT	180441	
		IGE XAO VAR3 SERVICE PACK 4 - (L84C)

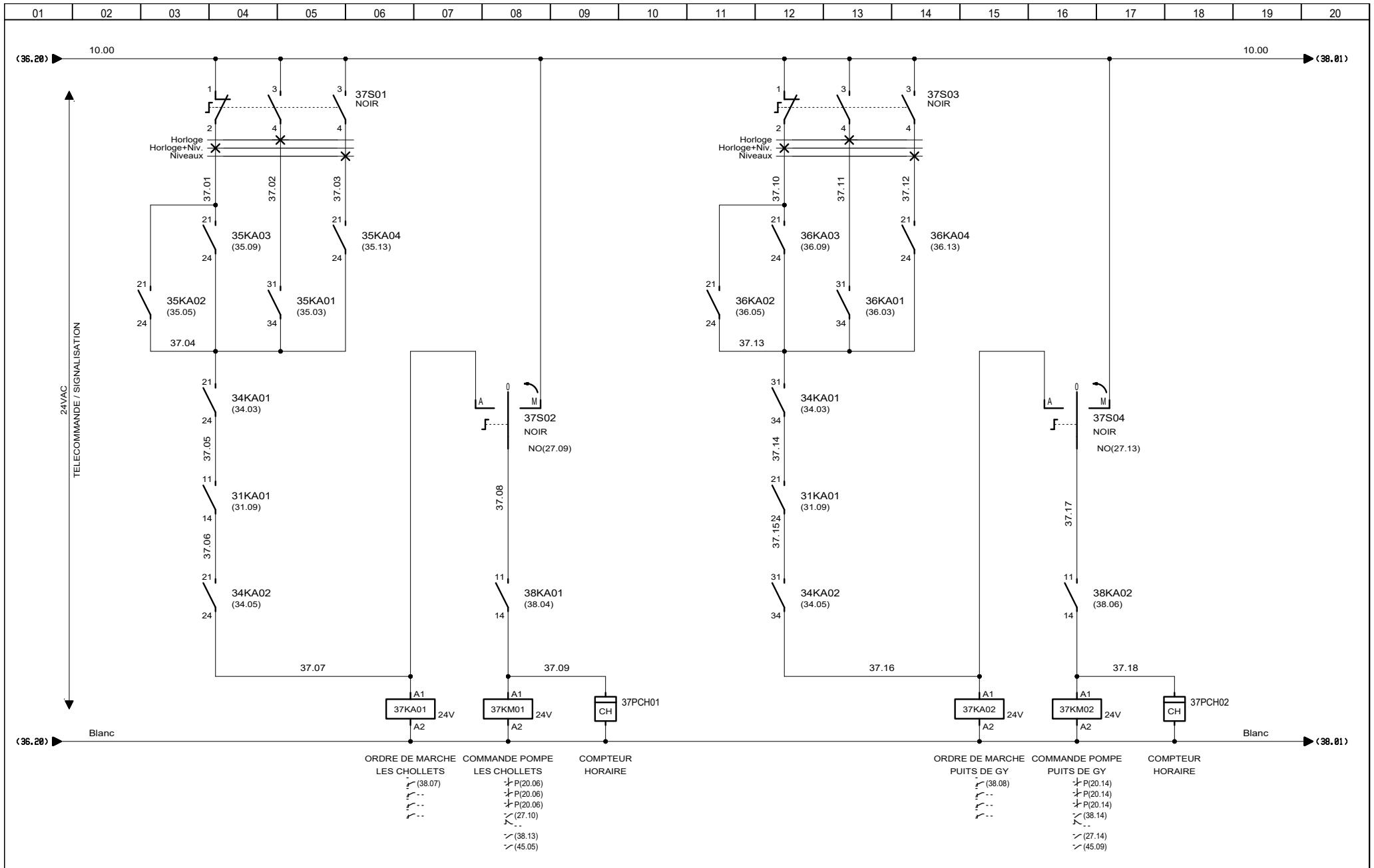

3, Rue Pierre Curie
91230 MONTGERON
Tél. : 01.69.52.47.00 - Fax : 01.69.52.47.01
e-mail : seguin@automatismes-seguin.fr
http://www.automatismes-seguin.fr

TELECOMMANDE

CLIENT ET NOM DU DOSSIER / CUSTOMER AND NAME OF FOLDER		INDICE / REVIEW
SAUR Station Paroy		0
DESSINATEUR DRAWER	Q.D.	IGE XAO
N° AFFAIRE N° PROJECT	180441	
FOLIO/SHEET 37/38		VAR3 SERVICE PACK 4 - (4.84C)

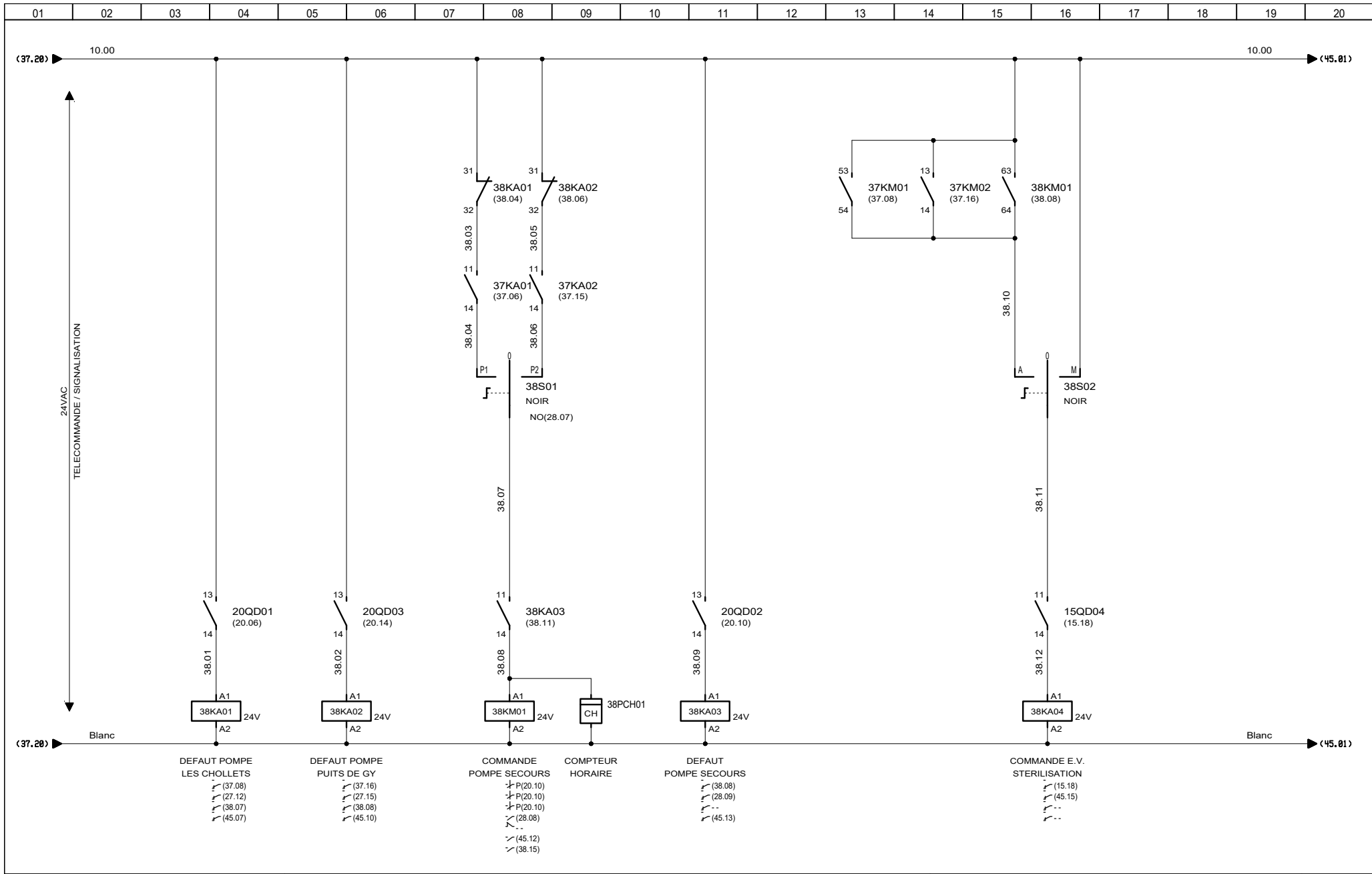

3, Rue Pierre Curie
91230 MONTGERON
Tél. : 01.69.52.47.00 - Fax : 01.69.52.47.01
e-mail : seguin@automatismes-seguin.fr
http://www.automatismes-seguin.fr

TELECOMMANDE

CLIENT ET NOM DU DOSSIER / CUSTOMER AND NAME OF FOLDER		INDICE / REVIEW
SAUR Station Paroy		0
DESSINATEUR DRAWER	Q.D.	IGE-XAO
N° AFFAIRE N° PROJECT	180441	
FOLIO/SHEET 38 / 45		VARS SERVICE PACK 4 - (L84C)

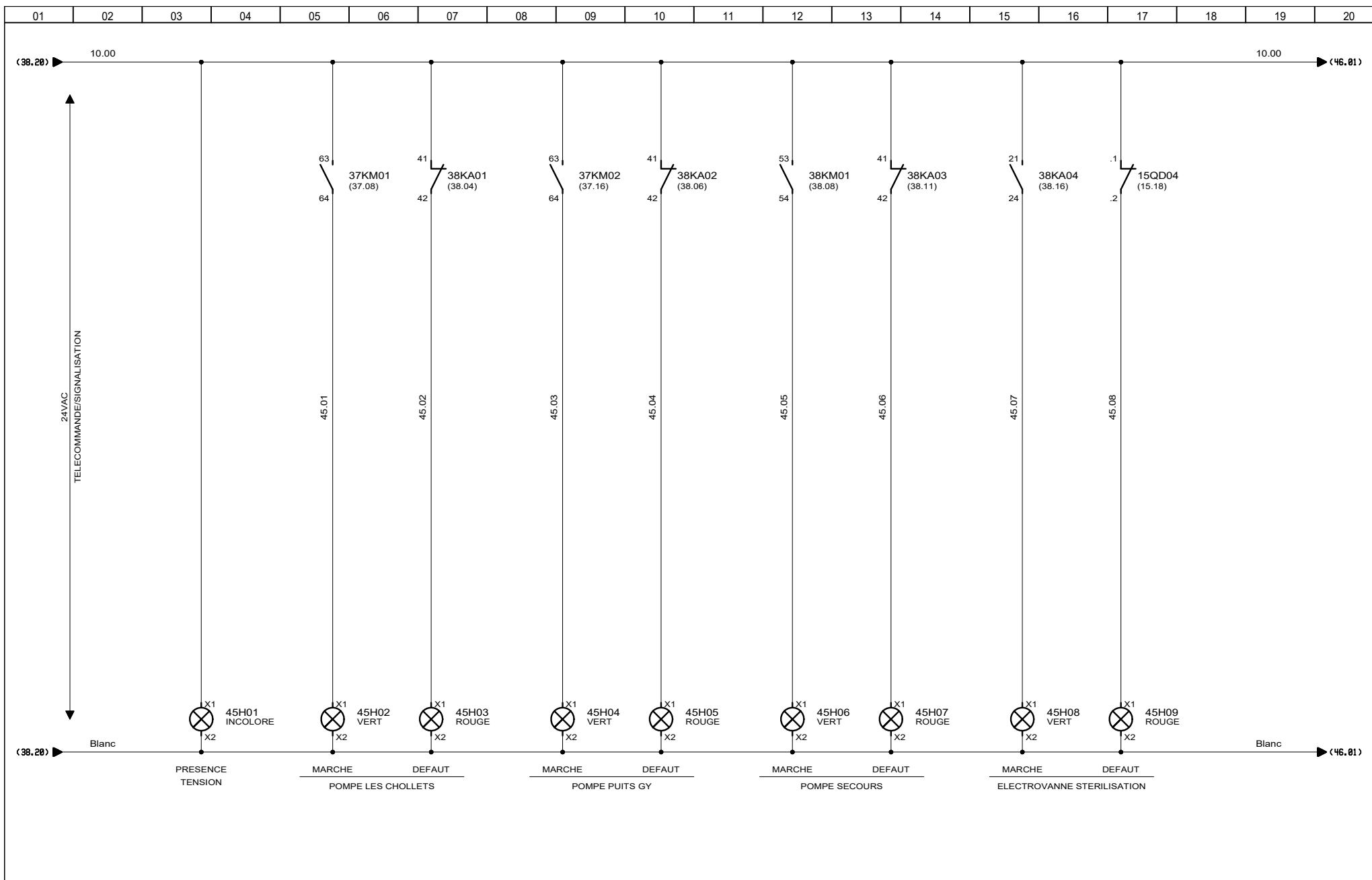

3, Rue Pierre Curie
91230 MONTGERON
Tél. : 01.69.52.47.00 - Fax : 01.69.52.47.01
e-mail : seguin@automatismes-seguin.fr
<http://www.automatismes-seguin.fr>

SIGNALISATION

CLIENT ET NOM DU DOSSIER / CUSTOMER AND NAME OF FOLDER		INDICE / REVIEW
SAUR Station Paroy		0
DESSINATEUR DRAWER	Q.D.	FOLIO/SHEET 45 / 46
N° AFFAIRE N° PROJECT	180441	
VARS SERVICE PACK 4 - (4.84C)		

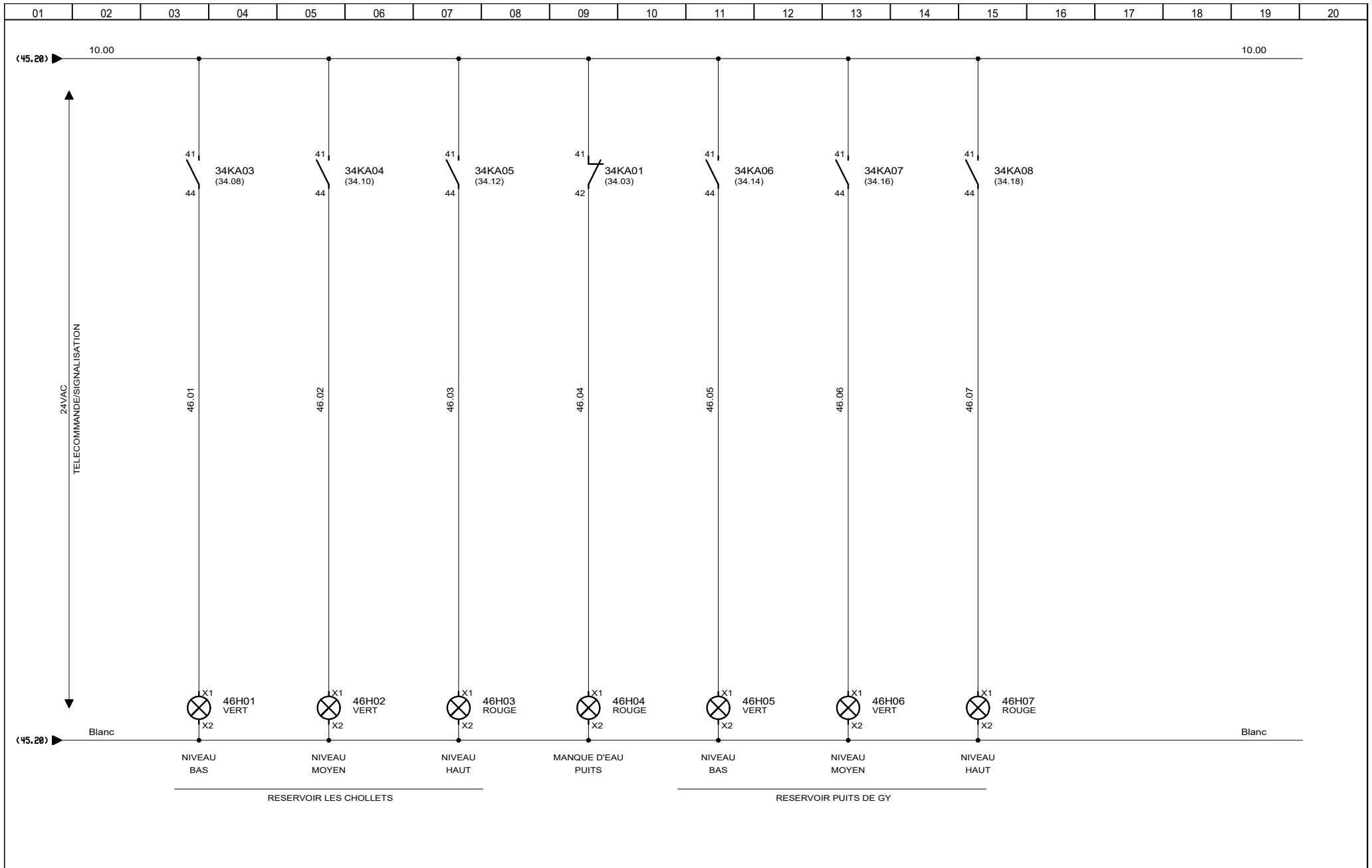

3, Rue Pierre Curie
91230 MONTGERON
Tél. : 01.69.52.47.00 - Fax : 01.69.52.47.01
e-mail : seguin@automatismes-seguin.fr
<http://www.automatismes-seguin.fr>

SIGNALISATION

CLIENT ET NOM DU DOSSIER / CUSTOMER AND NAME OF FOLDER		INDICE / REVIEW
SAUR Station Paroy		0
DESSINATEUR DRAWER	Q.D.	FOLIO/SHEET 46 / 50
N° AFFAIRE N° PROJECT	180441	
		IGE-XAO VAR3 SERVICE PACK 4 - (L84C)

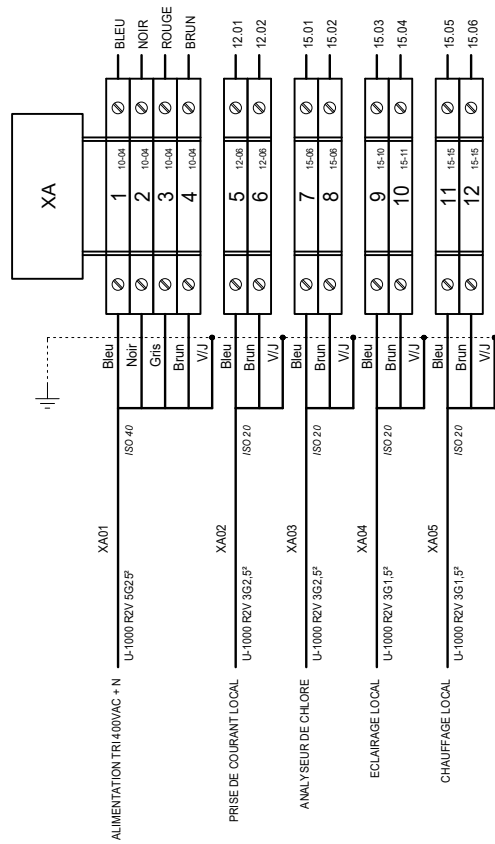

3, Rue Pierre Curie
 91230 MONTGERON
 Tél. : 01.69.52.47.00 - Fax : 01.69.52.47.01
 e-mail : seguin@automatismes-seguin.fr
 http://www.automatismes-seguin.fr

BORNIER XA ALIMENTATION

CLIENT ET NOM DU DOSSIER / CUSTOMER AND NAME OF FOLDER		INDICE / REVIEW
SAUR Station Paroy		0
DESSINATEUR DRAWER	Q.D.	FOLIO/SHEET 50 / 51
N° AFFAIRE N° PROJECT	180441	
		IGE-XAO VAR3 SERVICE PACK 4 - (4.843)

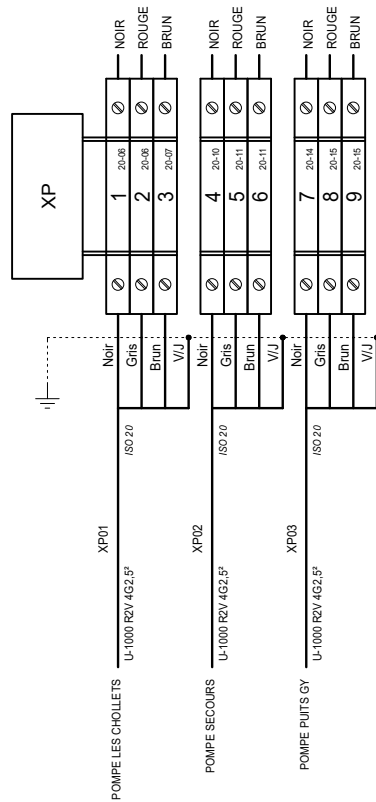

3, Rue Pierre Curie
91230 MONTGERON
Tél. : 01.69.52.47.00 - Fax : 01.69.52.47.01
e-mail : seguin@automatismes-seguin.fr
http://www.automatismes-seguin.fr

BORNIER XP PUISSANCE

CLIENT ET NOM DU DOSSIER / CUSTOMER AND NAME OF FOLDER		INDICE / REVIEW
SAUR Station Paroy		0
DESSINATEUR DRAWER	Q.D.	FOLIO/SHEET 51/52
N° AFFAIRE N° PROJECT	180441	
		IGE XAO VAR3 SERVICE PACK 4 - (4.84C)

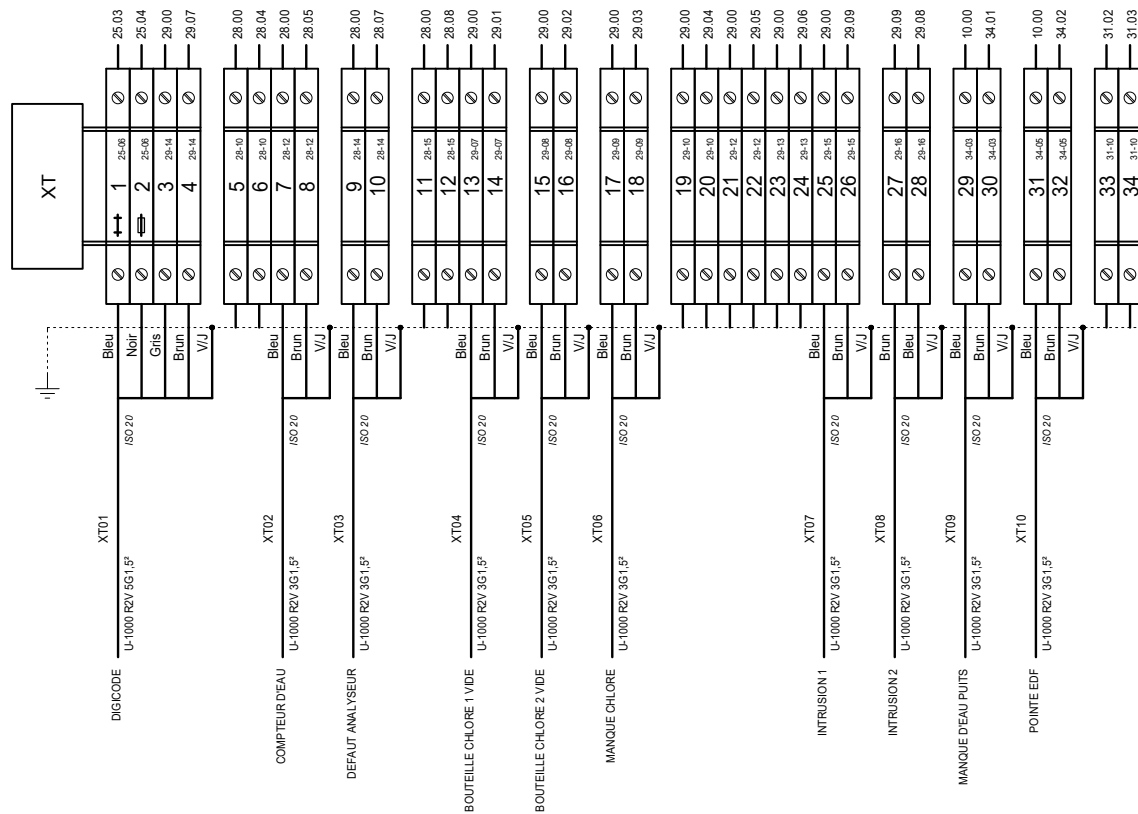

3, Rue Pierre Curie
91230 MONTGERON
Tél. : 01.69.52.47.00 - Fax : 01.69.52.47.01
e-mail : seguin@automatismes-seguin.fr
http://www.automatismes-seguin.fr

BORNIER XT TELECOMMANDE

CLIENT ET NOM DU DOSSIER / CUSTOMER AND NAME OF FOLDER		INDICE / REVIEW
SAUR Station Paroy		0
DESSINATEUR DRAWER	Q.D.	
N° AFFAIRE N° PROJECT	180441	
FOLIO/SHEET 52 / 53		

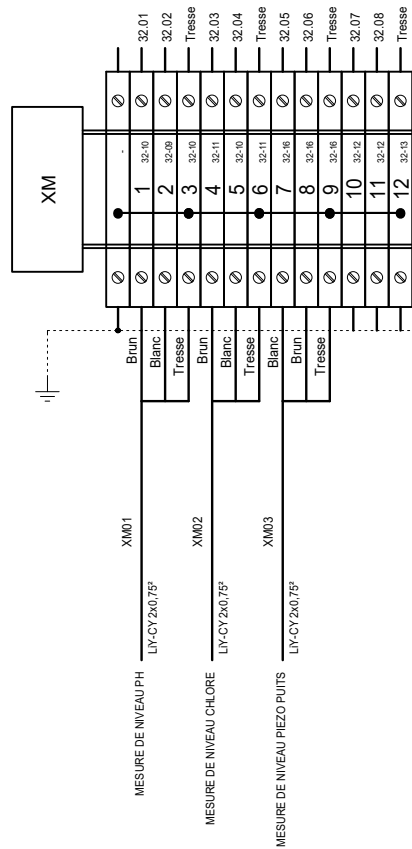

3, Rue Pierre Curie
91230 MONTGERON
Tél. : 01.69.52.47.00 - Fax : 01.69.52.47.01
e-mail : seguin@automatismes-seguin.fr
http://www.automatismes-seguin.fr

BORNIER XM MESURE

CLIENT ET NOM DU DOSSIER / CUSTOMER AND NAME OF FOLDER		INDICE / REVIEW
SAUR Station Paroy		0
DESSINATEUR DRAWER	Q.D.	FOLIO/SHEET 53 / 60
N° AFFAIRE N° PROJECT	180441	
		IGE XAO VAR3 SERVICE PACK 4 - (4.843)

REPERE	DESIGNATION	REFERENCE	MARQUE	QTE
	TOLERIE			
	COFFRET UNIVERSEL AVEC PORTE PLEINE SANS CHASSIS 1000x1000x300, IP55, RAL7035	NSYS3D101030D	SCHNEIDER ELECTRIC	1
	POCHETTE OUVERTE POUR PLANS AUTOCOLLANTE, 340x235mm (ACC D'ENVELOPPES)	036580	LEGRAND	1
	POIGNEE A CLE 1242E	NSYAEDL1242S3D	SCHNEIDER ELECTRIC	1
	JEU 4 PATTES DE FIXATION MURALE EN ACIER + CACHES	NSYAEFPFSC2	SCHNEIDER ELECTRIC	1
10E01	REPARTITEUR BIPOLAIRE BD 80/100 AL, 14 CONNEXIONS	563910	ERICO	1
10E02	BARRETTE DE COUPURE BASSE, PLATINE PLASTIQUE 95x20mm, L = 125mm	034389	LEGRAND	1
10KA01	RELAIS INDUSTRIEL EMBROCHABLE, MONOSTABLE, 4INV, 24VAC + EMBASE + ETRIER	2903686 + 2900934 + 2908043	PHOENIX CONTACT	1
10KA02	RELAIS TEMPORISE ELECTRONIQUE STATIQUE AU TRAVAIL 0.1-100h, 24-240V AC/DC	RE17LAMW	SCHNEIDER ELECTRIC	1
10PF01	RELAIS DE CONTROLE TRIPHASE POUR L'ORDRE ET LA PERTE DE PHASES, 208-480VAC, 1INV	DPA51CM44	CARLO GAVAZZI	1
10QD01	DISJONCTEUR IC60N 3P 1A, 440VAC/25kA, 133VDC/6kA, COURBE C	A9F74301	SCHNEIDER ELECTRIC	1
10QD02	DISJONCTEUR IC60N 2P 2A, 440VAC/25kA, 133VDC/6kA, COURBE C	A9F74202	SCHNEIDER ELECTRIC	1
10QD03	DISJONCTEUR DT40 1P+N 4A 6kA, COURBE C	A9N21022	SCHNEIDER ELECTRIC	1
10QD04	DISJONCTEUR DT40 1P+N 1A 6kA, COURBE C	A9N21019	SCHNEIDER ELECTRIC	1
10QDG01	INTERRUPTEUR DIFFERENTIEL IID TYPE AC 415VAC 4P 63A 300mA	A9R14463	SCHNEIDER ELECTRIC	1
	DECLENCHEUR A EMISSION DE TENSION IMX+OF 100-415V 50-60Hz / 110-130VDC	A9A26946	SCHNEIDER ELECTRIC	1
10S01	TETE ARRET D'URGENCE	ZB4BS844	SCHNEIDER ELECTRIC	1
	CORPS CONTACT NO	ZB4BZ101	SCHNEIDER ELECTRIC	1
	CONTACT VIS ETRIER 1NO	ZBE101	SCHNEIDER ELECTRIC	1
10TR01	TRANSFORMATEUR DE COMMANDE ET DE SIGNALISATION MONOPHASEE 230-400V/24-48V, 100VA	044233	LEGRAND	1
12ECH01	RESISTANCE CHAUFFANTE PTC CS 060, 120-240V AC/DC, 50W	06000-0-00	STEGO	1
12ECL01	LAMPE LED 5W 220V 50-60Hz 500lm	NSYLAMT5LD1	SCHNEIDER ELECTRIC	1
12KIH01	INTERRUPTEUR HORAIRE PROGRAMME JOURNALIER AUTOMATIQUE, 230VAC, 1 SORTIE 16A, 3 MODULES	412823	LEGRAND	1
12KIH02	INTERRUPTEUR HORAIRE PROGRAMME JOURNALIER AUTOMATIQUE, 230VAC, 1 SORTIE 16A, 3 MODULES	412823	LEGRAND	1
12KTH01	PETIT THERMOSTAT KTO 011, 1NF, 0..60°C	01146.9-00	STEGO	1
12QD01	DISJONCTEUR DT40 VIGI 1P+N CLASSE AC 16A 30mA COURBE C	A9N21444	SCHNEIDER ELECTRIC	1
12QD02	DISJONCTEUR DT40 1P+N 1A 6kA, COURBE C	A9N21019	SCHNEIDER ELECTRIC	1
12QD03	DISJONCTEUR DT40 1P+N 1A 6kA, COURBE C	A9N21019	SCHNEIDER ELECTRIC	1
12QD04	DISJONCTEUR DT40 1P+N 2A 6kA, COURBE C	A9N21020	SCHNEIDER ELECTRIC	1
12S01	CONTACT DE PORTE	NSYINLCRN	SCHNEIDER ELECTRIC	1
12X01	PRISE DE COURANT 2P+T 10/16A, 250VAC A ECLIPS	004280	LEGRAND	1
15QD01	DISJONCTEUR DT40 1P+N 4A 6kA, COURBE C	A9N21022	SCHNEIDER ELECTRIC	1
	BLOC VIGI DT40 1P+N CLASSE AC 25A 30mA 230VAC	A9N21450	SCHNEIDER ELECTRIC	1
15QD02	DISJONCTEUR DT40 1P+N 10A 6kA COURBE C	A9N21024	SCHNEIDER ELECTRIC	1
15QD03	DISJONCTEUR DT40 1P+N 10A 6kA COURBE C	A9N21024	SCHNEIDER ELECTRIC	1
15QD04	DISJONCTEUR DT40 1P+N 2A 6kA, COURBE C	A9N21020	SCHNEIDER ELECTRIC	1
	CONTACT OF + SD/OF 3A SOUS 415VAC/6A SOUS 240V AC	A9N26929	SCHNEIDER ELECTRIC	1
20PA01	AMPEREMETRE ROTEX R72A90-A, 0-25A-125A DIRECT DEV. 90D	192D1303	SOCOMEK	1
	2 CAPUCHONS	192Z1016	SOCOMEK	1
20PA02	AMPEREMETRE ROTEX R72A90-A, 0-25A-125A DIRECT DEV. 90D	192D1303	SOCOMEK	1
	2 CAPUCHONS	192Z1016	SOCOMEK	1
20PA03	AMPEREMETRE ROTEX R72A90-A, 0-25A-125A DIRECT DEV. 90D	192D1303	SOCOMEK	1
	2 CAPUCHONS	192Z1016	SOCOMEK	1
20QD01	DISJONCTEUR MOTEUR MAGNETO-THERMIQUE 13-18A, BORNES A VIS	GV2ME20	SCHNEIDER ELECTRIC	1
	ADDITIF FRONTAL F+O	GVAE11	SCHNEIDER ELECTRIC	1
20QD02	DISJONCTEUR MOTEUR MAGNETO-THERMIQUE 13-18A, BORNES A VIS	GV2ME20	SCHNEIDER ELECTRIC	1
	ADDITIF FRONTAL F+O	GVAE11	SCHNEIDER ELECTRIC	1
20QD03	DISJONCTEUR MOTEUR MAGNETO-THERMIQUE 13-18A, BORNES A VIS	GV2ME20	SCHNEIDER ELECTRIC	1



3, Rue Pierre Curie
91230 MONTGERON
Tél. : 01.69.52.47.00 - Fax : 01.69.52.47.01
e-mail : seguin@automatismes-seguin.fr
http://www.automatismes-seguin.fr

NOMENCLATURE

CLIENT ET NOM DU DOSSIER / CUSTOMER AND NAME OF FOLDER		INDICE / REVIEW
SAUR Station Paroy		0
DESSINATEUR DRAWER	Q.D.	FOLIO/SHEET 60 / 61
N° AFFAIRE N° PROJECT	180441	
		IGE-XAO VARS SERVICE PACK 4 - (A.B4C)

REPERE	DESIGNATION	REFERENCE	MARQUE	QTE
	ADDITIF FRONTAL F+O	GVAE11	SCHNEIDER ELECTRIC	1
25E01	RACK S550 8 EMBLEMENTS AVEC ALIM SECTEUR 230VAC	T9950A100	SOFREL	1
25E01-01	MODULE DE COMMUNICATION GSM/GPRS-3 + ANTENNE BI-BANDE	V5900540	SOFREL	1
25E01-02	MODULE D'ENTREES, 8E TOR	V5900210	SOFREL	1
25E01-03	MODULE D'ENTREES, 8E TOR	V5900210	SOFREL	1
25E01-04	MODULE D'ENTREES, 8E TOR	V5900210	SOFREL	1
25E01-05	MODULE DE SORTIES, 4S TOR 1S TOR WDG 50V 1A	V5900310	SOFREL	1
25E01-06	MODULE DE SORTIES 2S 50V 1A	V5900320	SOFREL	1
25E01-07	MODULE D'ENTREES, 4E ANA MULTISTANDARD	V5900250	SOFREL	1
25FP01	PROTECTION SECTEUR 230V, 5kA, Up=1.2kV	T5300011	SOFREL	1
25G01	BATTERIE 12V, 7Ah	NP7-12FR	YUASA	1
25QD01	DISJONCTEUR DT40 1P+N 4A 6kA, COURBE C	A9N21022	SCHNEIDER ELECTRIC	1
E01	RACK S550 8 EMBLEMENTS AVEC ALIM SECTEUR 230VAC	T9950A100	SOFREL	1
	AUTOMATISME PROGRAMMABLE EN LANGAGE ST	TS9500A10	SOFREL	1
31KA01	RELAIS INDUSTRIEL EMBROCHABLE, MONOSTABLE, 4INV, 24VAC + EMBASE + ETRIER	2903686 + 2900934 + 2908043	PHOENIX CONTACT	1
34KA01	RELAIS INDUSTRIEL EMBROCHABLE, MONOSTABLE, 4INV, 24VAC + EMBASE + ETRIER	2903686 + 2900934 + 2908043	PHOENIX CONTACT	1
34KA02	RELAIS INDUSTRIEL EMBROCHABLE, MONOSTABLE, 4INV, 24VAC + EMBASE + ETRIER	2903686 + 2900934 + 2908043	PHOENIX CONTACT	1
34KA03	RELAIS INDUSTRIEL EMBROCHABLE, MONOSTABLE, 4INV, 24VAC + EMBASE + ETRIER	2903686 + 2900934 + 2908043	PHOENIX CONTACT	1
34KA04	RELAIS INDUSTRIEL EMBROCHABLE, MONOSTABLE, 4INV, 24VAC + EMBASE + ETRIER	2903686 + 2900934 + 2908043	PHOENIX CONTACT	1
34KA05	RELAIS INDUSTRIEL EMBROCHABLE, MONOSTABLE, 4INV, 24VAC + EMBASE + ETRIER	2903686 + 2900934 + 2908043	PHOENIX CONTACT	1
34KA06	RELAIS INDUSTRIEL EMBROCHABLE, MONOSTABLE, 4INV, 24VAC + EMBASE + ETRIER	2903686 + 2900934 + 2908043	PHOENIX CONTACT	1
34KA07	RELAIS INDUSTRIEL EMBROCHABLE, MONOSTABLE, 4INV, 24VAC + EMBASE + ETRIER	2903686 + 2900934 + 2908043	PHOENIX CONTACT	1
34KA08	RELAIS INDUSTRIEL EMBROCHABLE, MONOSTABLE, 4INV, 24VAC + EMBASE + ETRIER	2903686 + 2900934 + 2908043	PHOENIX CONTACT	1
34S01	TETE BOUTON TOURNANT 2 POSITIONS	ZB4BD2	SCHNEIDER ELECTRIC	1
	CORPS CONTACT NO	ZB4BZ101	SCHNEIDER ELECTRIC	1
35KA01	RELAIS INDUSTRIEL EMBROCHABLE, MONOSTABLE, 4INV, 24VAC + EMBASE + ETRIER	2903686 + 2900934 + 2908043	PHOENIX CONTACT	1
35KA02	RELAIS INDUSTRIEL EMBROCHABLE, MONOSTABLE, 4INV, 24VAC + EMBASE + ETRIER	2903686 + 2900934 + 2908043	PHOENIX CONTACT	1
35KA03	RELAIS INDUSTRIEL EMBROCHABLE, MONOSTABLE, 4INV, 24VAC + EMBASE + ETRIER	2903686 + 2900934 + 2908043	PHOENIX CONTACT	1
35KA04	RELAIS INDUSTRIEL EMBROCHABLE, MONOSTABLE, 4INV, 24VAC + EMBASE + ETRIER	2903686 + 2900934 + 2908043	PHOENIX CONTACT	1
36KA01	RELAIS INDUSTRIEL EMBROCHABLE, MONOSTABLE, 4INV, 24VAC + EMBASE + ETRIER	2903686 + 2900934 + 2908043	PHOENIX CONTACT	1
36KA02	RELAIS INDUSTRIEL EMBROCHABLE, MONOSTABLE, 4INV, 24VAC + EMBASE + ETRIER	2903686 + 2900934 + 2908043	PHOENIX CONTACT	1
36KA03	RELAIS INDUSTRIEL EMBROCHABLE, MONOSTABLE, 4INV, 24VAC + EMBASE + ETRIER	2903686 + 2900934 + 2908043	PHOENIX CONTACT	1
36KA04	RELAIS INDUSTRIEL EMBROCHABLE, MONOSTABLE, 4INV, 24VAC + EMBASE + ETRIER	2903686 + 2900934 + 2908043	PHOENIX CONTACT	1
37KA01	RELAIS INDUSTRIEL EMBROCHABLE, MONOSTABLE, 4INV, 24VAC + EMBASE + ETRIER	2903686 + 2900934 + 2908043	PHOENIX CONTACT	1
37KA02	RELAIS INDUSTRIEL EMBROCHABLE, MONOSTABLE, 4INV, 24VAC + EMBASE + ETRIER	2903686 + 2900934 + 2908043	PHOENIX CONTACT	1
37PCH01	COMPTEUR HORAIRE TOTALISATEUR 10...30V, 50Hz	3220401071	KUBLER	1
	CADRE POUR COMPTEUR DIN H57	BT008171	KUBLER	1
37PCH02	COMPTEUR HORAIRE TOTALISATEUR 10...30V, 50Hz	3220401071	KUBLER	1
	CADRE POUR COMPTEUR DIN H57	BT008171	KUBLER	1
37S01	TETE BOUTON TOURNANT 3 POSITIONS	ZB4BD3	SCHNEIDER ELECTRIC	1
	CORPS CONTACT 2NO	ZB4BZ103	SCHNEIDER ELECTRIC	1
	CONTACT VIS ETRIER 1NF	ZBE102	SCHNEIDER ELECTRIC	1
37S02	TETE BOUTON TOURNANT 3 POSITIONS, RAPPEL DE DROITE AU CENTRE	ZB4BD8	SCHNEIDER ELECTRIC	1
	CORPS CONTACT 2NO	ZB4BZ103	SCHNEIDER ELECTRIC	1
	CONTACT VIS ETRIER 1NO	ZBE101	SCHNEIDER ELECTRIC	1
	CONTACT VIS ETRIER 1NF	ZBE102	SCHNEIDER ELECTRIC	1
37S03	TETE BOUTON TOURNANT 3 POSITIONS	ZB4BD3	SCHNEIDER ELECTRIC	1



3, Rue Pierre Curie
91230 MONTGERON
Tél. : 01.69.52.47.00 - Fax : 01.69.52.47.01
e-mail : seguin@automatismes-seguin.fr
http://www.automatismes-seguin.fr

NOMENCLATURE

CLIENT ET NOM DU DOSSIER / CUSTOMER AND NAME OF FOLDER		INDICE / REVIEW
SAUR Station Paroy		0
DESSINATEUR DRAWER	Q.D.	FOLIO/SHEET 61/62
N° AFFAIRE N° PROJECT	180441	
		IGE-XAO VAR3 SERVICE PACK 4 - (4.84C)

REPERE	DESIGNATION	REFERENCE	MARQUE	QTE
	CORPS CONTACT 2NO	ZB4BZ103	SCHNEIDER ELECTRIC	1
	CONTACT VIS ETRIER 1NF	ZBE102	SCHNEIDER ELECTRIC	1
37S04	TETE BOUTON TOURNANT 3 POSITIONS, RAPPEL DE DROITE AU CENTRE	ZB4BD8	SCHNEIDER ELECTRIC	1
	CORPS CONTACT 2NO	ZB4BZ103	SCHNEIDER ELECTRIC	1
	CONTACT VIS ETRIER 1NO	ZBE101	SCHNEIDER ELECTRIC	1
	CONTACT VIS ETRIER 1NF	ZBE102	SCHNEIDER ELECTRIC	1
38KA01	RELAIS INDUSTRIEL EMBROCHABLE, MONOSTABLE, 4INV, 24VAC + EMBASE + ETRIER	2903686 + 2900934 + 2908043	PHOENIX CONTACT	1
38KA02	RELAIS INDUSTRIEL EMBROCHABLE, MONOSTABLE, 4INV, 24VAC + EMBASE + ETRIER	2903686 + 2900934 + 2908043	PHOENIX CONTACT	1
38KA03	RELAIS INDUSTRIEL EMBROCHABLE, MONOSTABLE, 4INV, 24VAC + EMBASE + ETRIER	2903686 + 2900934 + 2908043	PHOENIX CONTACT	1
38KA04	RELAIS INDUSTRIEL EMBROCHABLE, MONOSTABLE, 4INV, 24VAC + EMBASE + ETRIER	2903686 + 2900934 + 2908043	PHOENIX CONTACT	1
38PCH01	COMPTEUR HORAIRE TOTALISATEUR 10...30V, 50Hz	3220401071	KUBLER	1
	CADRE POUR COMPTEUR DIN H57	BT008171	KUBLER	1
38S01	TETE BOUTON TOURNANT 3 POSITIONS, RAPPEL DE DROITE AU CENTRE	ZB4BD8	SCHNEIDER ELECTRIC	1
	CORPS CONTACT 2NO	ZB4BZ103	SCHNEIDER ELECTRIC	1
	CONTACT VIS ETRIER 1NO	ZBE101	SCHNEIDER ELECTRIC	1
38S02	TETE BOUTON TOURNANT 3 POSITIONS, RAPPEL DE DROITE AU CENTRE	ZB4BD8	SCHNEIDER ELECTRIC	1
	CORPS CONTACT 2NO	ZB4BZ103	SCHNEIDER ELECTRIC	1
	CONTACT VIS ETRIER 1NO	ZBE101	SCHNEIDER ELECTRIC	1
45H01	VOYANT INCOLORE DEL 24V	XB7EV07BP	SCHNEIDER ELECTRIC	1
45H02	VOYANT VERT DEL 24V	XB7EV03BP	SCHNEIDER ELECTRIC	1
45H03	VOYANT ROUGE DEL 24V	XB7EV04BP	SCHNEIDER ELECTRIC	1
45H04	VOYANT VERT DEL 24V	XB7EV03BP	SCHNEIDER ELECTRIC	1
45H05	VOYANT ROUGE DEL 24V	XB7EV04BP	SCHNEIDER ELECTRIC	1
45H06	VOYANT VERT DEL 24V	XB7EV03BP	SCHNEIDER ELECTRIC	1
45H07	VOYANT ROUGE DEL 24V	XB7EV04BP	SCHNEIDER ELECTRIC	1
45H08	VOYANT VERT DEL 24V	XB7EV03BP	SCHNEIDER ELECTRIC	1
45H09	VOYANT ROUGE DEL 24V	XB7EV04BP	SCHNEIDER ELECTRIC	1
46H01	VOYANT VERT DEL 24V	XB7EV03BP	SCHNEIDER ELECTRIC	1
46H02	VOYANT VERT DEL 24V	XB7EV03BP	SCHNEIDER ELECTRIC	1
46H03	VOYANT ROUGE DEL 24V	XB7EV04BP	SCHNEIDER ELECTRIC	1
46H04	VOYANT ROUGE DEL 24V	XB7EV04BP	SCHNEIDER ELECTRIC	1
46H05	VOYANT VERT DEL 24V	XB7EV03BP	SCHNEIDER ELECTRIC	1
46H06	VOYANT VERT DEL 24V	XB7EV03BP	SCHNEIDER ELECTRIC	1
46H07	VOYANT ROUGE DEL 24V	XB7EV04BP	SCHNEIDER ELECTRIC	1



3, Rue Pierre Curie
91230 MONTGERON
Tél. : 01.69.52.47.00 - Fax : 01.69.52.47.01
e-mail : seguin@automatismes-seguin.fr
http://www.automatismes-seguin.fr

NOMENCLATURE

CLIENT ET NOM DU DOSSIER / CUSTOMER AND NAME OF FOLDER		INDICE / REVIEW
SAUR Station Paroy		0
DESSINATEUR DRAWER	Q.D.	FOLIO/SHEET 62 / 62
N° AFFAIRE N° PROJECT	180441	
		IGE XAO VAR3 SERVICE PACK 4 - (4.84C)