

23/01/2018	0	M.H.	RETOUR ESSAIS	K.C.	F.C.
05/12/2017	B	F.CO.	MISE A JOUR	K.C.	F.C.
18/10/2017	A	F.CO.	PREMIERE EMISSION	F.C.	E.A.
DATE	REV.	DESSINE PAR	MODIFICATIONS	VERIFIE PAR	APPROUVE PAR
DATE	REV.	DRAWN BY	REVISIONS	CHECKED BY	APPROVED BY

SCHEMA ELECTRIQUE ELECTRICAL DRAWING



3, Rue Pierre Curie
91230 MONTGERON
Tél. : 01.69.52.47.00 - Fax : 01.69.52.47.01
e-mail : seguin@automatismes-seguin.fr
<http://www.automatismes-seguin.fr>

PLAN: 170415	REV: 0
CDE:	

Ce document est notre propriété. Il ne peut être reproduit et / ou communiqué sans autorisation.
This document is our property. It cannot be reproduced and / or transmitted without authorization.



Coffret Orconte

LETTRE DE REPERAGE DES ELEMENTS DU SCHEMA

QI	INTERRUPTEUR	PCPI	CONTROLEUR D'ISOLEMENT	KT	RELAIS TEMPORISE	SA	COMMUTATEUR D'AMPEREMETRE
QIG	INTERRUPTEUR GENERAL	TR	TRANSFORMATEUR DE TENSION	KAU	RELAIS ARRÊT D'URGENCE	SV	COMMUTATEUR DE VOLTMETRE
QD	DISJONCTEUR	TC	TRANSFORMATEUR DE COURANT	UF	VARIATEUR	ECH	RESISTANCE CHAUFFANTE
QDG	DISJONCTEUR GENERAL	U	ONDULEUR, ALIMENTATION	UM	DEMARREUR	ECL	ECLAIRAGE
FP	PARAFODRE	KIC	INTER CREPUSCULAIRE	S	ORGANE DE COMMANDE	G	BATTERIE
FU	FUSIBLE	KIH	HORLOGE	H	VOYANT, SIRENE	P	INSTRUMENTATION
F	THERMIQUE	KTH	THERMOSTAT	PCH	COMPTEUR HORAIRE	X	PRISE DE COURANT, BORNIER
QF	SECTIONNEUR FUSIBLE	KM	CONTACTEUR	PA	AMPEREMETRE	E	MATERIELS AUTRES
PF	CONTROLEUR DE PHASE	KA	RELAIS	PV	VOLTMETRE	KTL	TELERUPTEUR

LETTER CODES FOR ITEMS DESIGNATION ON THE DRAWING

QI	SWITCH	PCPI	INSULATION CONTROLLER	KT	TEMPORIZES RELAY	SA	AMPEREMETER SWITCH
QIG	GENERAL SWITCH	TR	TENSION TRANSFORMER	KAU	EMERGENCY STOP RELAY	SV	VOLTMETER SWITCH
QD	BREAKER	TC	CURRENT TRANSFORMER	UF	VELOCITY VARIATOR	ECL	LIGHT
QDG	GENERAL BREAKER	U	INVERTER, SUPPLY	UM	MOTOR STARTER	ECH	HEATER
FP	LIGHTNING PROTECTOR	KIC	DIMMER	S	CONTROL UNIT	G	BATTERY
FU	FUSE	KIH	CLOCK	H	INDICATOR	P	INSTRUMENTATION
F	THERMAL RELAY	KTH	THERMOSTAT	PCH	TIMER	X	SOCKET, TERMINAL BLOCK
QF	DISCONNECTING SWITCH	KM	CONTACTOR	PA	AMPEREMETER	E	OTHER EQUIPMENTS
PF	PHASE CONTROLLER	KA	RELAY	PV	VOLTMETER	KTL	TELEBREAKER

COULEURS DE FILS

TRI 400V: <= 6 mm2 Noir Rouge Brun
> 6 mm2 Noir Bagué Noir Rouge Brun

NEUTRE: Bleu Clair

230VAC: Rouge avec Commun Bobines Blanc (*)

230VAC ONDULE: Neutre Bleu Clair Bagué Orange
Phase Noir Bagué Orange

110VAC: Noir avec Commun Bobines Blanc (*)

24VAC: Violet avec Commun Bobines Blanc (*)

24VDC: Bleu Foncé avec Commun Bobines Blanc (*)

48VAC: Violet avec Commun Bobines Blanc (*)

48VDC: Bleu Foncé avec Commun Bobines Blanc (*)

REPORTS: Orange

TERRE: Vert/Jaune

ANALOGIQUE: Une Paire + Brun - Blanc
Unifilaire Blanc

TENSION EXTERNE PERMANENTE INTER GENERAL OUVERT: Orange

ATTENTION

Si plusieurs tensions de télécommande, alors prendre uniquement le 230VAC avec Commun Bobines Blanc

(*) Si Télécommande

WIRE COLOR

TRI 400V: <= 6 mm2 Black Red Brown
> 6 mm2 Black with Ring Black Red Brown

NEUTRE: Light Blue

230VAC: Red with Spods Common White (*)

230VAC UPS: Neutre Light Blue with Ring Orange
Phase Black with Ring Orange
Black with Spods Common White (*)

110VAC: Black with Spods Common White (*)

24VAC: Purple with Spods Common White (*)

24VDC: Dark Bleu with Spods Common White (*)

48VAC: Purple with Spods Common White (*)

48VDC: Dark Bleu with Spods Common White (*)

REPORTS: Orange

GROUND: Green/Yellow

ANALOGICAL: One Pair + Brown - White
Unifilar White

PERMANENTLY EXTERNAL POWER GENERAL BREAKER OPEN: Orange

CAUTION

If There are Several Tensions of Command Then to take Only the 230VAC with Spods Common White

(*) If Command

TYPE DE RELAIS ET DE CONTACT DANS LE SCHEMA



RELAY AND CONTACT TYPE IN THE DRAWING

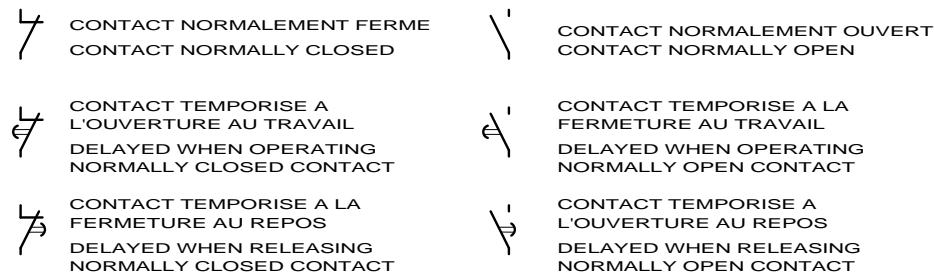

LE SCHEMA EST REPRESENTE HORS TENSION ET GENERATEUR HORS SERVICE

THE DRAWING IS SHOWN OUT OF VOLTAGE AND WITH GENERATOR OUT OF SERVICE



3, Rue Pierre Curie
91230 MONTGERON
Tél. : 01.69.52.47.00 - Fax : 01.69.52.47.01
e-mail : seguin@automatismes-seguin.fr
http://www.automatismes-seguin.fr

LEGENDE DU SCHEMA ELECTRIQUE

CLIENT ET NOM DU DOSSIER / CUSTOMER AND NAME OF FOLDER		INDICE / REVIEW
SAUR		0
Coffret Orconte		
DESSINATEUR / DRAWER	F.CO.	IGE-XAO
N° AFFAIRE / N° PROJECT	170415	FOLIO/SHEET 03/04
		VARI SERVICE PACK 9 - (L49A)

CODE DU REPERAGE

LETTER CODE

1/ DES APPAREILS DANS LES ARMOIRES
APPARATUS IN THE CABINETS



52 KA 01

N° D'ORDRE DANS LE FOLIO D'ORIGINE
ORDER NUMBER ON ORIGINAL SHEET

LETTRE DE REPERAGE
LETTER CODES FOR ITEM

N° DU FOLIO D'ORIGINE
ORIGINAL SHEET NUMBER

2/ DES FILS DE CABLAGE
WIRING

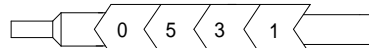

N° DU FOLIO D'ORIGINE
ORIGINAL SHEET NUMBER

N° DU FIL DANS LE FOLIO D'ORIGINE
NUMBER OF THE WIRE ON ORIGINAL SHEET

3/ REPORT DES CONTACTS DANS LE SCHEMA
CONTACT REPORT IN THE DRAWING

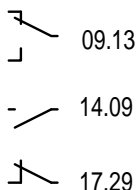

17.29

N° DE LA COLONNE OU EST UTILISE LE CONTACT
COLUMN NUMBER WHERE THE CONTACT IS USED

N° DU FOLIO OU EST UTILISE LE CONTACT
SHEET NUMBER WHERE THE CONTACT IS USED

4/ REPRESENTATION DES BORNES ET BORNIERES DANS LE SCHEMA
BINDINGS SCREWS VIEW IN THE DRAWING



N° D'ORDRE (SI NECESSAIRE)
ORDER NUMBER (IF NECESSARY)

NATURE DU BORNIER
NATURE OF TERMINAL BLOCK

A : ALIMENTATION
P : PUISSANCE
T : TELECOMMANDE
M : MESURE
R : REPORTS



LE SCHEMA EST REPRESENTE HORS TENSION ET GENERATEUR HORS SERVICE

THE DRAWING IS SHOWN OUT OF VOLTAGE AND WITH GENERATOR OUT OF SERVICE



3, Rue Pierre Curie
91230 MONTGERON
Tél. : 01.69.52.47.00 - Fax : 01.69.52.47.01
e-mail : seguin@automatismes-seguin.fr
http://www.automatismes-seguin.fr

LEGENDE DU SCHEMA ELECTRIQUE

CLIENT ET NOM DU DOSSIER / CUSTOMER AND NAME OF FOLDER		INDICE / REVIEW
SAUR		0
Coffret Orconte		
DESSINATEUR DRAWER	F.CO.	FOLIO/SHEET 04 / 05
N° AFFAIRE N° PROJECT	170415	
		IGE-XAO VARI SERVICE PACK 9 - (L49A)

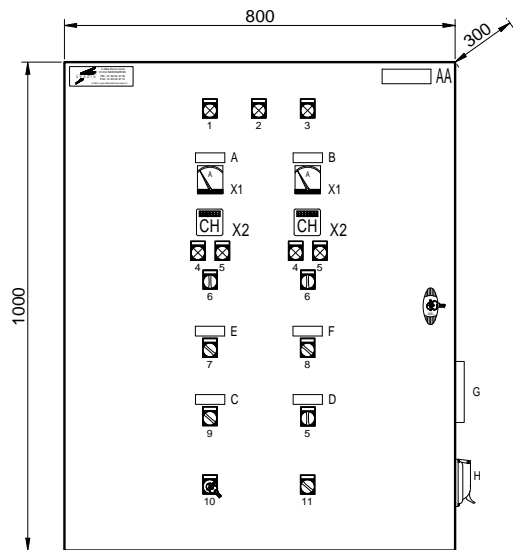

FACADE

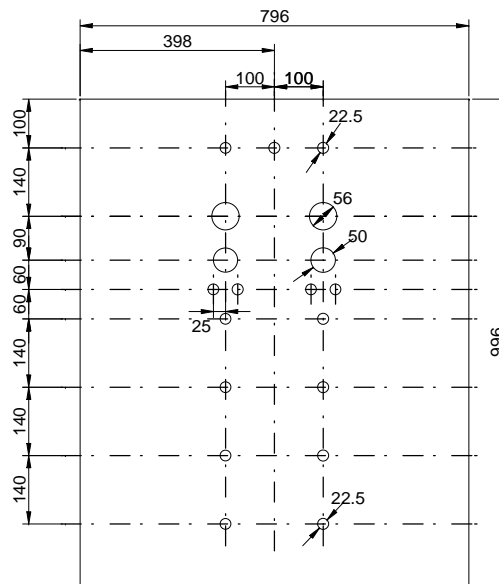

PLAN DE DECOUPE

ETIQUETTES 100x30

AA - ORCONTE

ETIQUETTES 60x20

- A - POMPE 1
- B - POMPE 2
- C - CHAUFFAGE
- D - POMPE JAVEL
- E - HORLOGE
- F - FLOTTEURS
- G - COMMANDE CHAUFFAGE
- H - PC 230VAC 16A

ETIQUETTES SCHNEIDER

- 1 - MANQUE D'EAU PUIITS
- 2 - SOUS TENSION
- 3 - DEFAUT SOFREL
- 4 - MARCHE
- 5 - DEFAUT
- 6 - AUTO / 0 / MAIN
- 7 - SANS / AVEC HORLOGE
- 8 - SANS / AVEC FLOTTEURS
- 9 - ARRET / MARCHE
- 10 - NORMAL / INTERVENTION
- 11 - NORMAL / SECOURS

DIVERS

- X1 - AMPEREMETRE
- X2 - COMPTEUR HORAIRE



3, Rue Pierre Curie
91230 MONTGERON
Tél. : 01.69.52.47.00 - Fax : 01.69.52.47.01
e-mail : seguin@automatismes-seguin.fr
http://www.automatismes-seguin.fr

IMPLANTATION FACADE

CLIENT ET NOM DU DOSSIER / CUSTOMER AND NAME OF FOLDER		INDICE / REVIEW
SAUR		0
Coffret Orconte		
DESSINATEUR DRAWER	M.H.	IGE XAO
N° AFFAIRE N° PROJECT	170415	FOLIO/SHEET 05 / 10
		VARI SERVICE PACK 9 - (L49A)

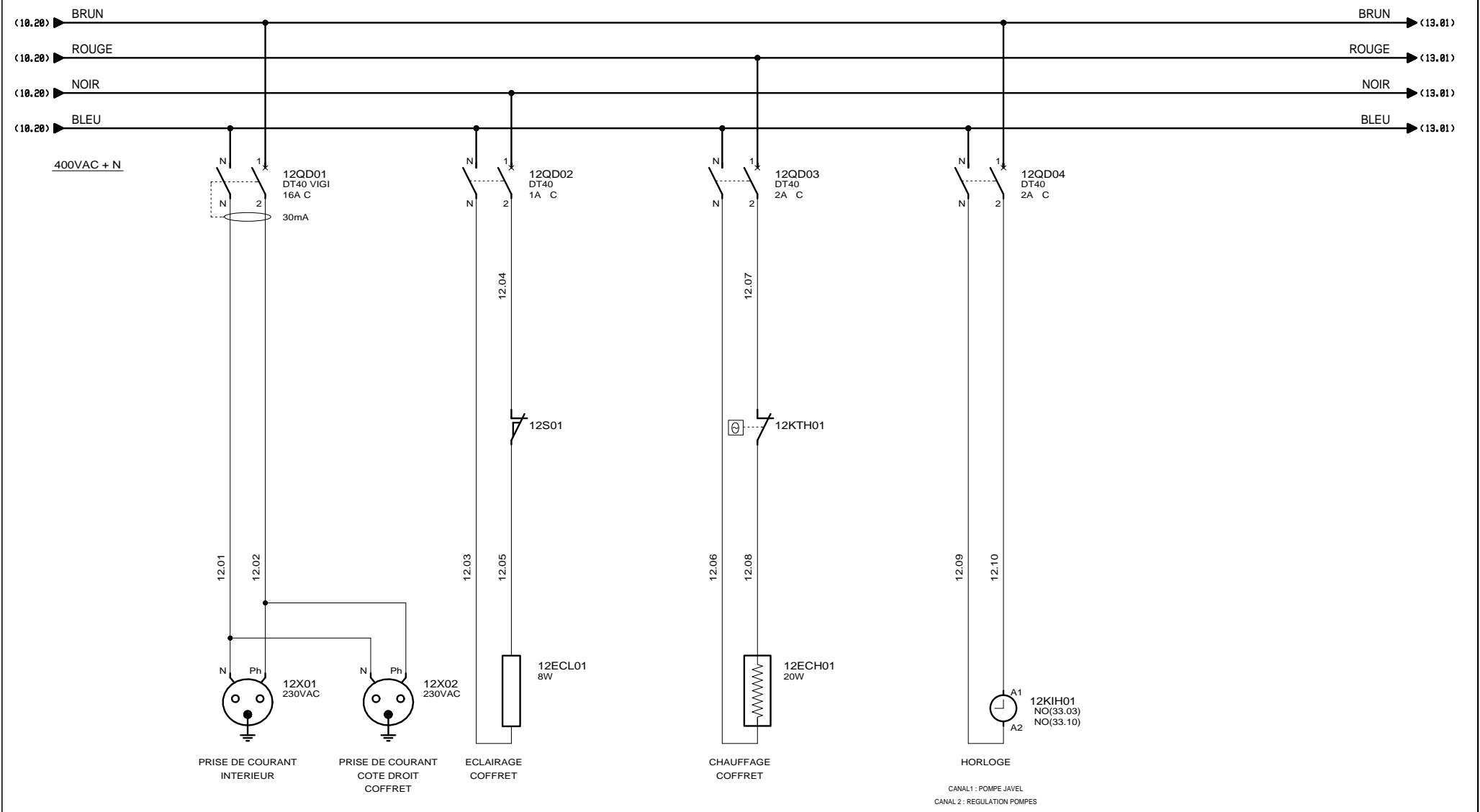

AUTOMATISMES SEGUIN
Systeme Qualité

3, Rue Pierre Curie
91230 MONTGERON
Tél. : 01.69.52.47.00 - Fax : 01.69.52.47.01
e-mail : seguin@automatismes-seguin.fr
http://www.automatismes-seguin.fr

DISTRIBUTION 400VAC + N UTILITES

CLIENT ET NOM DU DOSSIER / CUSTOMER AND NAME OF FOLDER		INDICE / REVIEW
SAUR Coffret Orconte		0
DESSINATEUR DRAWER	M.H.	FOLIO/SHEET 12 / 13
N° AFFAIRE N° PROJECT	170415	
VARI SERVICE PACK 9 - (L49A)		

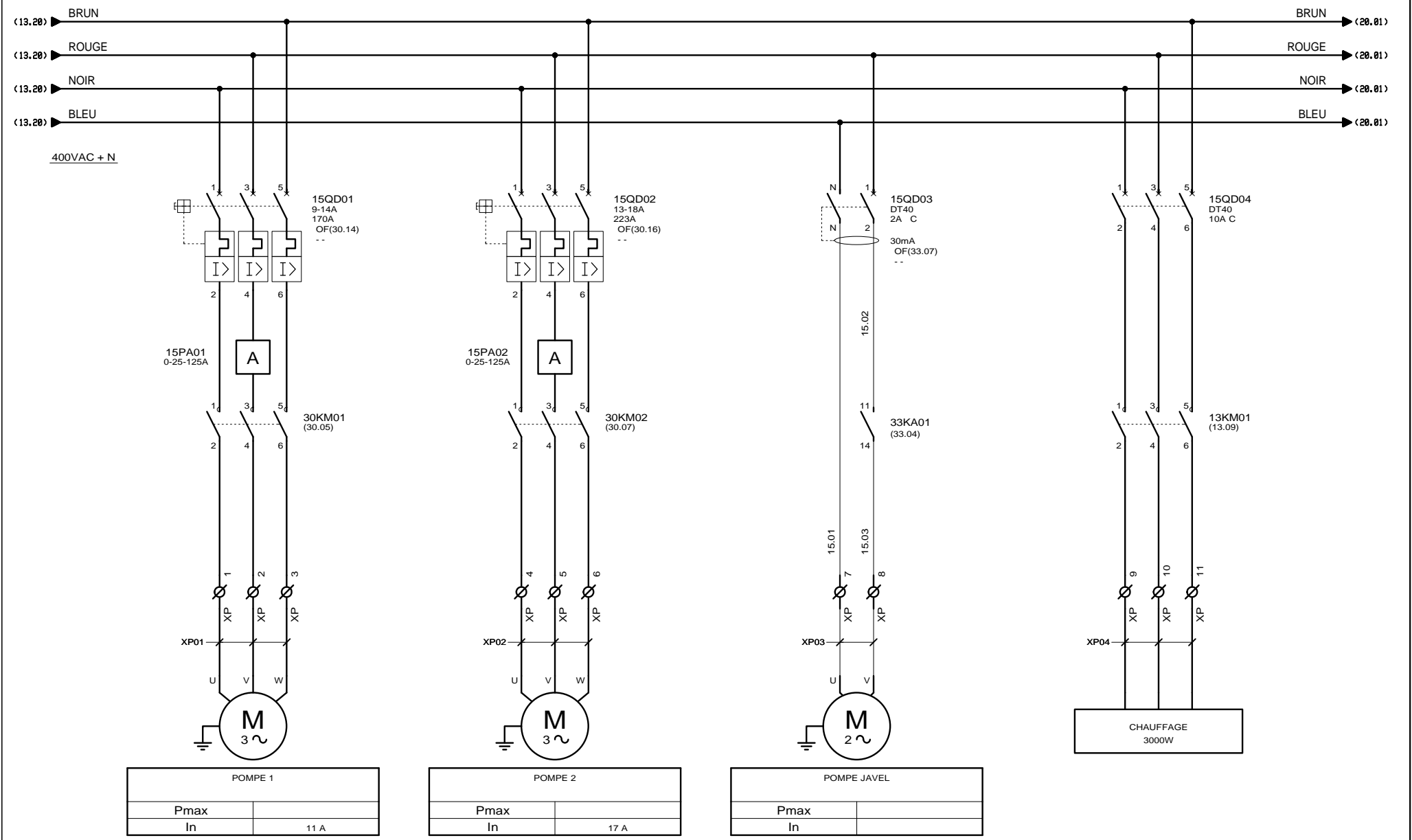

POMPE 1	
Pmax	
In	11 A

POMPE 2	
Pmax	
In	17 A

POMPE JAVEL	
Pmax	
In	

PUISSANCE POMPES

AUTOMATISMES SEGUIN
 Systeme Qualité
 3, Rue Pierre Curie
 91230 MONTGERON
 Tél. : 01.69.52.47.00 - Fax : 01.69.52.47.01
 e-mail : seguin@automatismes-seguin.fr
 http://www.automatismes-seguin.fr

CLIENT ET NOM DU DOSSIER / CUSTOMER AND NAME OF FOLDER		
SAUR Coffret Orconte		
INDICE / REVIEW	0	
DESSINATEUR DRAWER	F.CO.	FOLIO/SHEET 15 / 20
N° AFFAIRE N° PROJECT	170415	
VARD SERVICE PACK 9 - (L49A)		

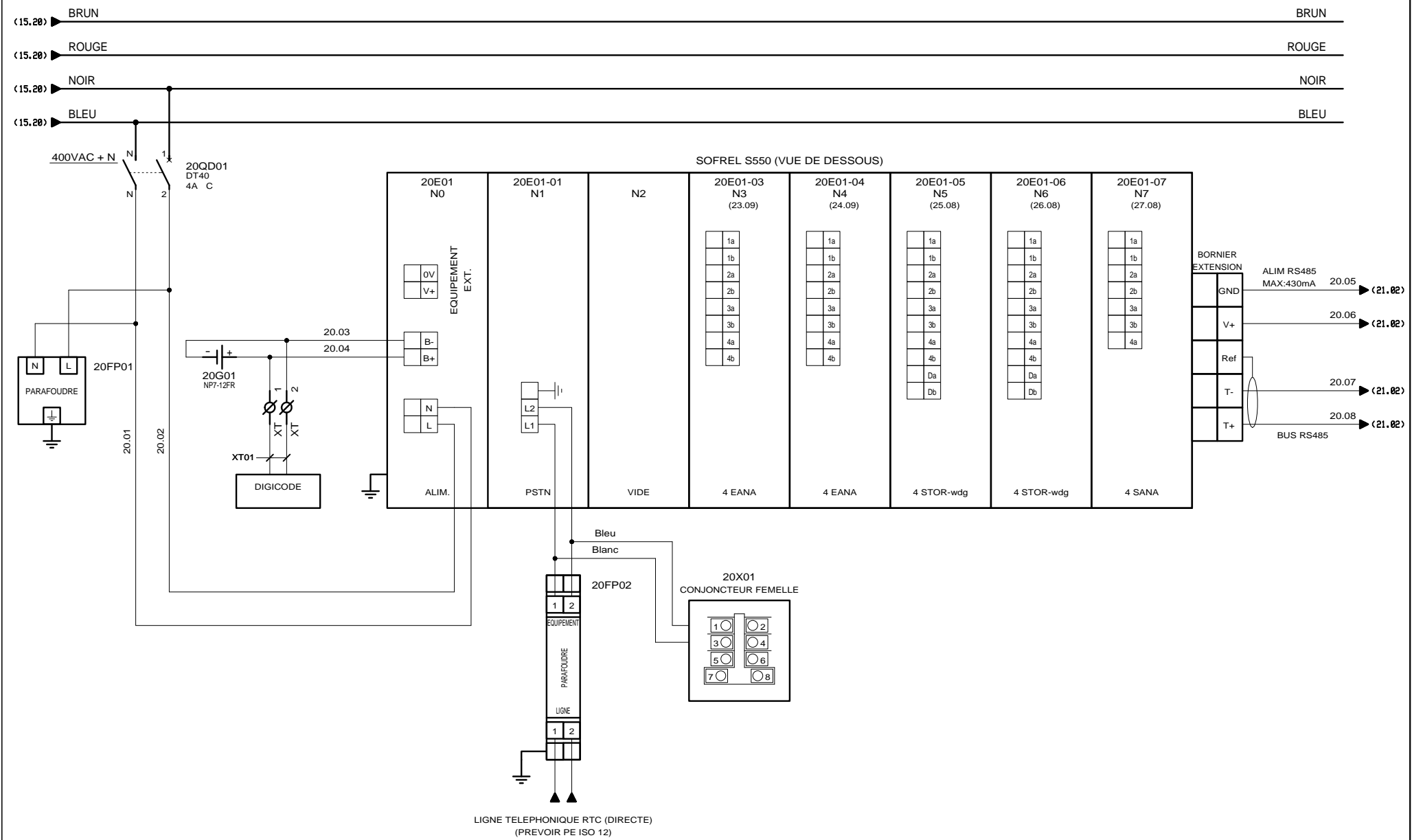

AUTOMATISMES SEGUIN
 Systeme Qualité
 3, Rue Pierre Curie
 91230 MONTGERON
 Tél. : 01.69.52.47.00 - Fax : 01.69.52.47.01
 e-mail : seguin@automatismes-seguin.fr
 http://www.automatismes-seguin.fr

ALIMENTATION SOFREL S550

CLIENT ET NOM DU DOSSIER / CUSTOMER AND NAME OF FOLDER		INDICE / REVIEW
SAUR Coffret Orconte		0
DESSINATEUR DRAWER	F.CO.	IGE-XAO
N° AFFAIRE N° PROJECT	170415	
FOLIO/SHEET		20/21
VARI SERVICE PACK 9 - (L49A)		

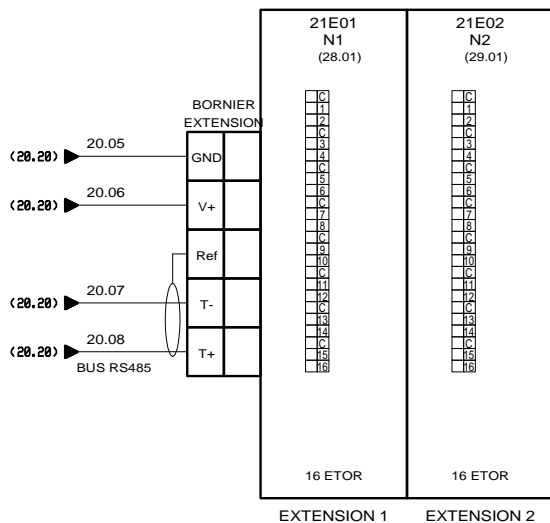

3, Rue Pierre Curie
91230 MONTGERON
Tél. : 01.69.52.47.00 - Fax : 01.69.52.47.01
e-mail : seguin@automatismes-seguin.fr
<http://www.automatismes-seguin.fr>

EXTENSIONS SOFREL S550

CLIENT ET NOM DU DOSSIER / CUSTOMER AND NAME OF FOLDER		INDICE / REVIEW
SAUR Coffret Orconte		0
DESSINATEUR DRAWER	F.CO.	FOLIO/SHEET 21/23
N° AFFAIRE N° PROJECT	170415	
		IGE-XAO VAR2 SERVICE PACK 9 - (L49A)

RACCORDEMENT :
POUR CAPTEUR AUTONOME

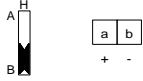

RACCORDEMENT :
POUR CAPTEUR TELEALIMENTE

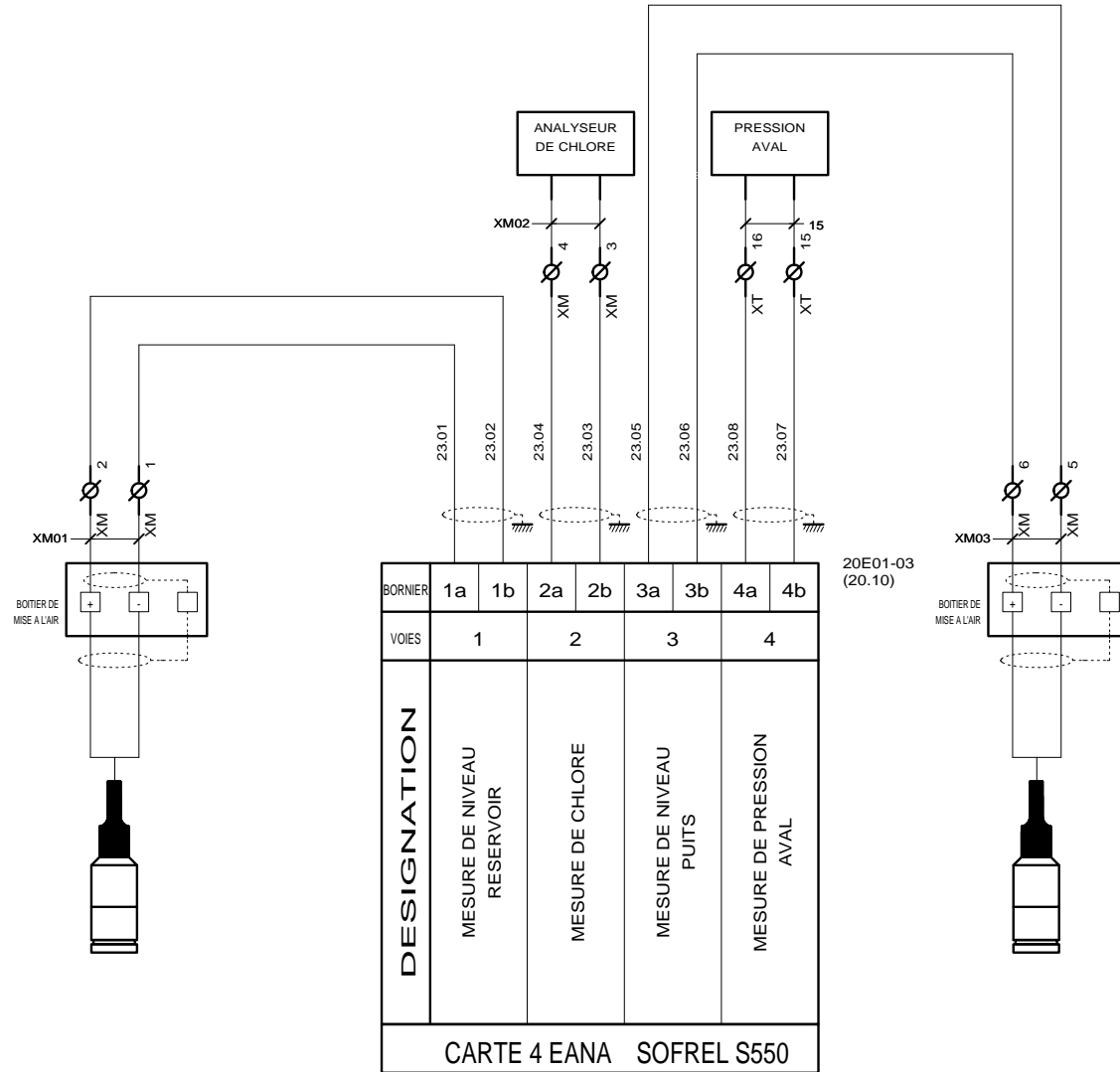
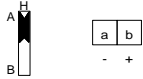

3, Rue Pierre Curie
91230 MONTGERON
Tél. : 01.69.52.47.00 - Fax : 01.69.52.47.01
e-mail : seguin@automatismes-seguin.fr
http://www.automatismes-seguin.fr

CARTE 4 ENTREES ANALOGIQUES EMPLACEMENT 3

CLIENT ET NOM DU DOSSIER / CUSTOMER AND NAME OF FOLDER		INDICE / REVIEW
SAUR Coffret Orconte		0
DESSINATEUR DRAWER	F.CO.	FOLIO/SHEET 23 / 24
N° AFFAIRE N° PROJECT	170415	
		VARD SERVICE PACK 9 - (L49A)

RACCORDEMENT :
POUR CAPTEUR AUTONOME

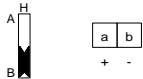

RACCORDEMENT :
POUR CAPTEUR TELEALIMENTE

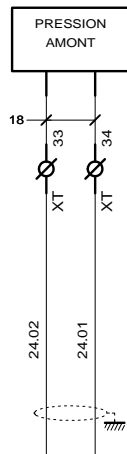
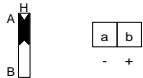

20E01-04
(20.12)

BORNIER	1a	1b	2a	2b	3a	3b	4a	4b
VOIES	1		2		3		4	
DESIGNATION	MESURE DE PRESSION AMONT							
CARTE 4 EANA SOFREL S550								



3, Rue Pierre Curie
91230 MONTGERON
Tél. : 01.69.52.47.00 - Fax : 01.69.52.47.01
e-mail : seguin@automatismes-seguin.fr
http://www.automatismes-seguin.fr

CARTE 4 ENTREES ANALOGIQUES EMPLACEMENT 4

CLIENT ET NOM DU DOSSIER / CUSTOMER AND NAME OF FOLDER		INDICE / REVIEW
SAUR Coffret Orconte		0
DESSINATEUR DRAWER	F.CO.	FOLIO/SHEET 24 / 25
N° AFFAIRE N° PROJECT	170415	
		IGE XAO VAR2 SERVICE PACK 9 - (L4.49.A)

CARTE 4 STOR-WDG SOFREL S550										
DESIGNATION	MANQUE DIEAU PUIITS				FORCAGE DISTANCE				CHIEN DE GARDE	
	1	2	3	4	5					
VOIES	1		2		3		4		5	
BORNIER	1a	1b	2a	2b	3a	3b	4a	4b	Da	Db

20E01-05
(20.13)

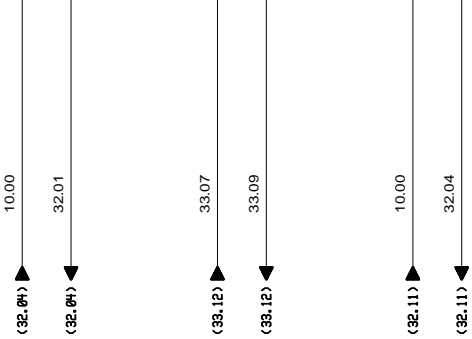

3, Rue Pierre Curie
91230 MONTGERON
Tél. : 01.69.52.47.00 - Fax : 01.69.52.47.01
e-mail : seguin@automatismes-seguin.fr
http://www.automatismes-seguin.fr

**CARTE 4 SORTIES TOR
EMPLACEMENT 5**

CLIENT ET NOM DU DOSSIER / CUSTOMER AND NAME OF FOLDER		INDICE / REVIEW
SAUR Coffret Orconte		0
DESSINATEUR DRAWER	F.CO.	FOLIO/SHEET 25 / 26
N° AFFAIRE N° PROJECT	170415	
		IGE XAO VAR2 SERVICE PACK 9 - (L49.A)

CARTE 4 STOR-wdg SOFREL S550									
DESIGNATION									
COMMANDE POMPE 1 SURPRESSEUR		COMMANDE POMPE 2 SURPRESSEUR		COMMANDE POMPE 3 SURPRESSEUR		COMMANDE POMPE 4 INCENDIE		CHIEN DE GARDE	
VOIES		1		2		3		4	
BORNIER		1a	1b	2a	2b	3a	3b	4a	4b
		Da	Db						

20E01-06
(20.15)

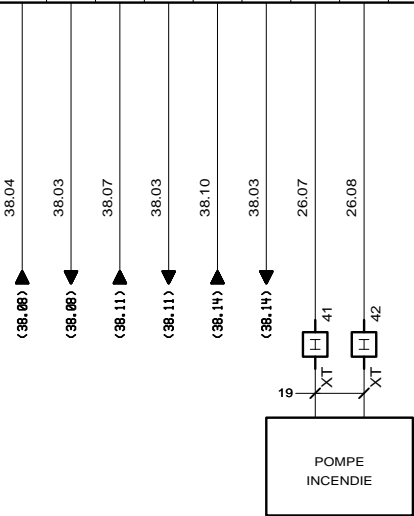

3, Rue Pierre Curie
91230 MONTGERON
Tél. : 01.69.52.47.00 - Fax : 01.69.52.47.01
e-mail : seguin@automatismes-seguin.fr
http://www.automatismes-seguin.fr

**CARTE 4 SORTIES TOR
EMPLACEMENT 6**

CLIENT ET NOM DU DOSSIER / CUSTOMER AND NAME OF FOLDER			INDICE / REVIEW
SAUR Coffret Orconte			0
DESSINATEUR DRAWER	M.H.	FOLIO/SHEET	26 / 27
N° AFFAIRE N° PROJECT	170415	IGE XAO VAR2 SERVICE PACK 9 - (L4.49.A)	

CARTE 4 SANA SOFREL S550									
DESIGNATION									
	1		2		3		4		
	POLARITE	+	-	+	-	+	-	+	-
	BORNIER	1a	1b	2a	2b	3a	3b	4a	4b

20E01-07
(20.16)



3, Rue Pierre Curie
91230 MONTGERON
Tél. : 01.69.52.47.00 - Fax : 01.69.52.47.01
e-mail : seguin@automatismes-seguin.fr
http://www.automatismes-seguin.fr

**CARTE 4 SORTIES ANALOGIQUES
EMPLACEMENT 7**

CLIENT ET NOM DU DOSSIER / CUSTOMER AND NAME OF FOLDER			INDICE / REVIEW
SAUR Coffret Orconte			0
DESSINATEUR DRAWER	F.CO.	FOLIO/SHEET	27 / 28
N° AFFAIRE N° PROJECT	170415		

VARI SERVICE PACK 9 - (L4.49.A)

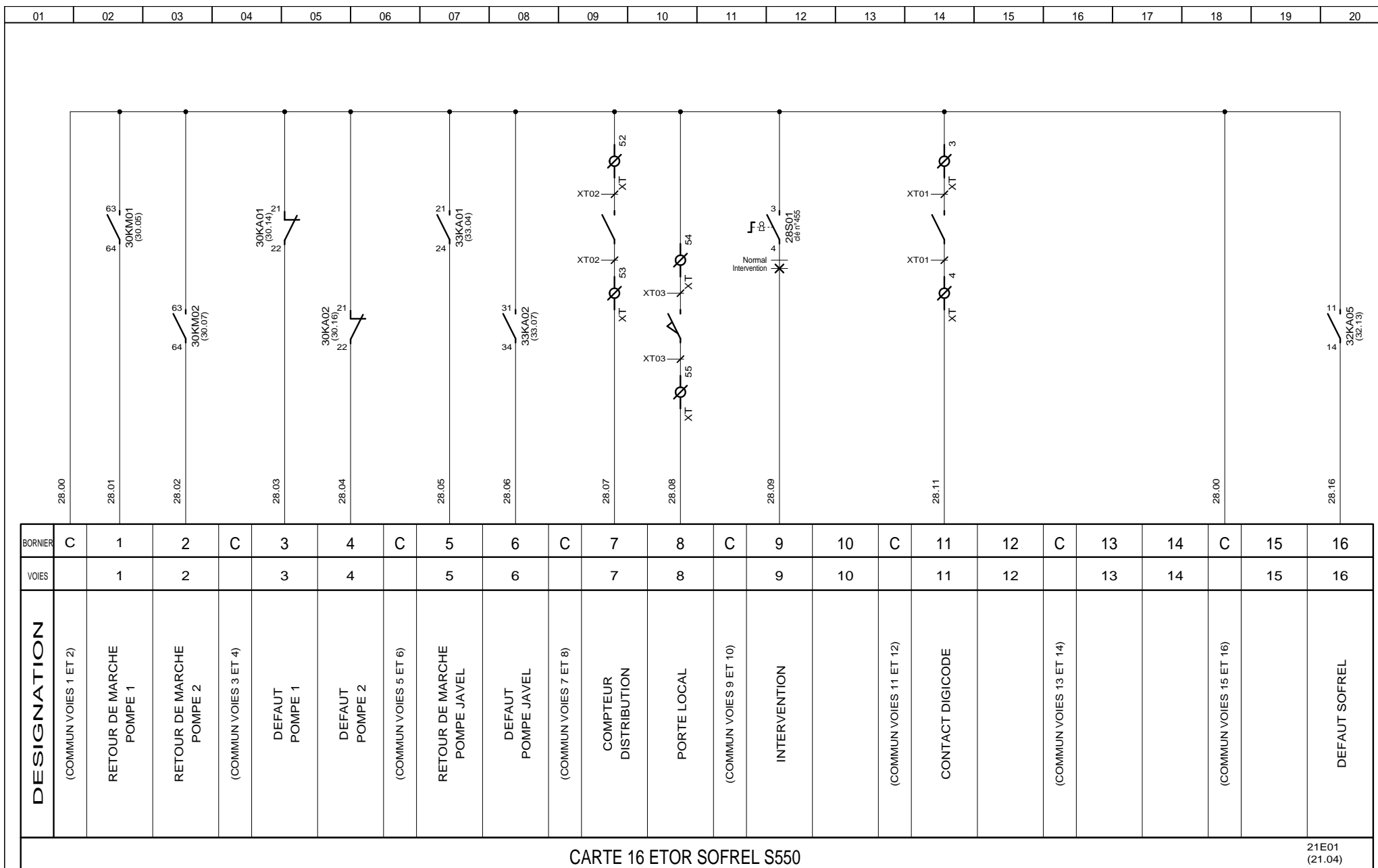

CARTE 16 ETOR SOFREL S550

21E01
(21.04)



3, Rue Pierre Curie
91230 MONTGERON
Tél. : 01.69.52.47.00 - Fax : 01.69.52.47.01
e-mail : seguin@automatismes-seguin.fr
http://www.automatismes-seguin.fr

CARTE 16 ENTrees TOR EXTENSION 1

CLIENT ET NOM DU DOSSIER / CUSTOMER AND NAME OF FOLDER		INDICE / REVIEW
SAUR Coffret Orconte		0
DESSINATEUR DRAWER	F.CO.	FOLIO/SHEET 28 / 29
N° AFFAIRE N° PROJECT	170415	
		VARI SERVICE PACK 9 - (L49A)

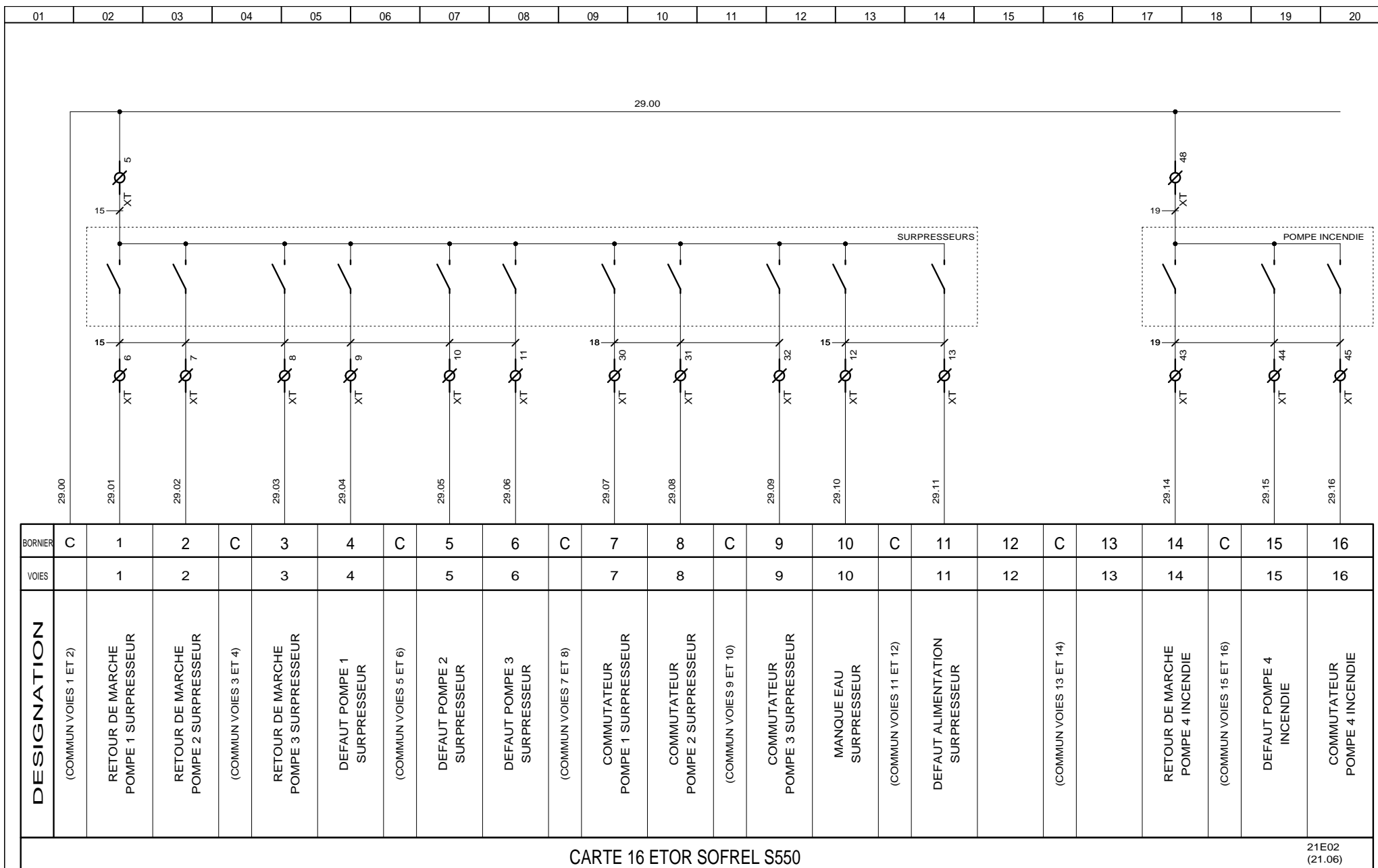

CARTE 16 ETOR SOFREL S550

21E02
(21.06)



3, Rue Pierre Curie
91230 MONTGERON
Tél. : 01.69.52.47.00 - Fax : 01.69.52.47.01
e-mail : seguin@automatismes-seguin.fr
http://www.automatismes-seguin.fr

CARTE 16 ENTRES TOR
EXTENSION 2

CLIENT ET NOM DU DOSSIER / CUSTOMER AND NAME OF FOLDER		INDICE / REVIEW
SAUR Coffret Orconte		0
DESSINATEUR DRAWER	M.H.	IGE XAO
N° AFFAIRE N° PROJECT	170415	
FOLIO/SHEET 29/30		VARD SERVICE PACK 9 - (L49A)

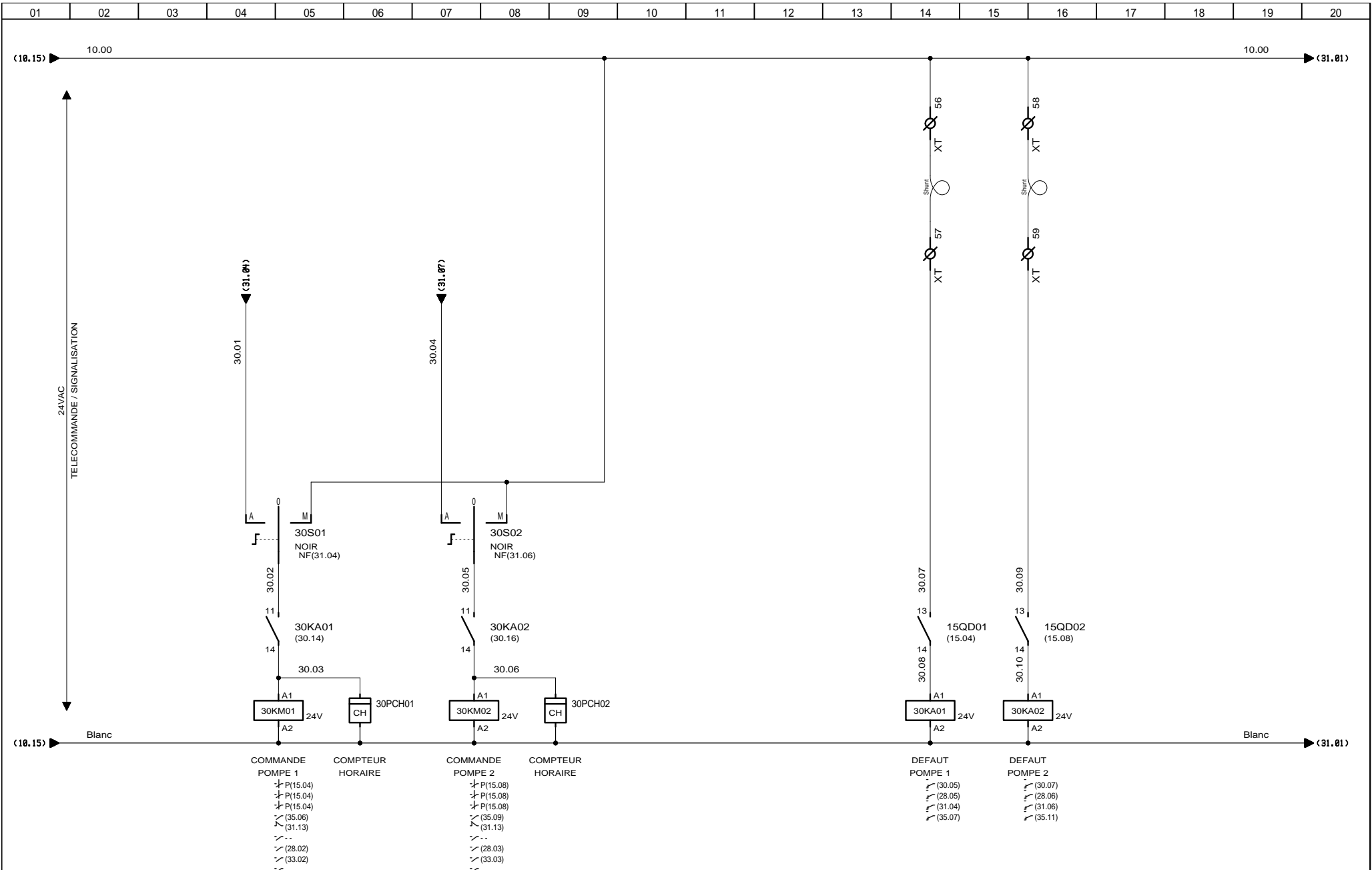



 3, Rue Pierre Curie
 91230 MONTGERON
 Tél. : 01.69.52.47.00 - Fax : 01.69.52.47.01
 e-mail : seguin@automatismes-seguin.fr
 http://www.automatismes-seguin.fr

TELECOMMANDE POMPES

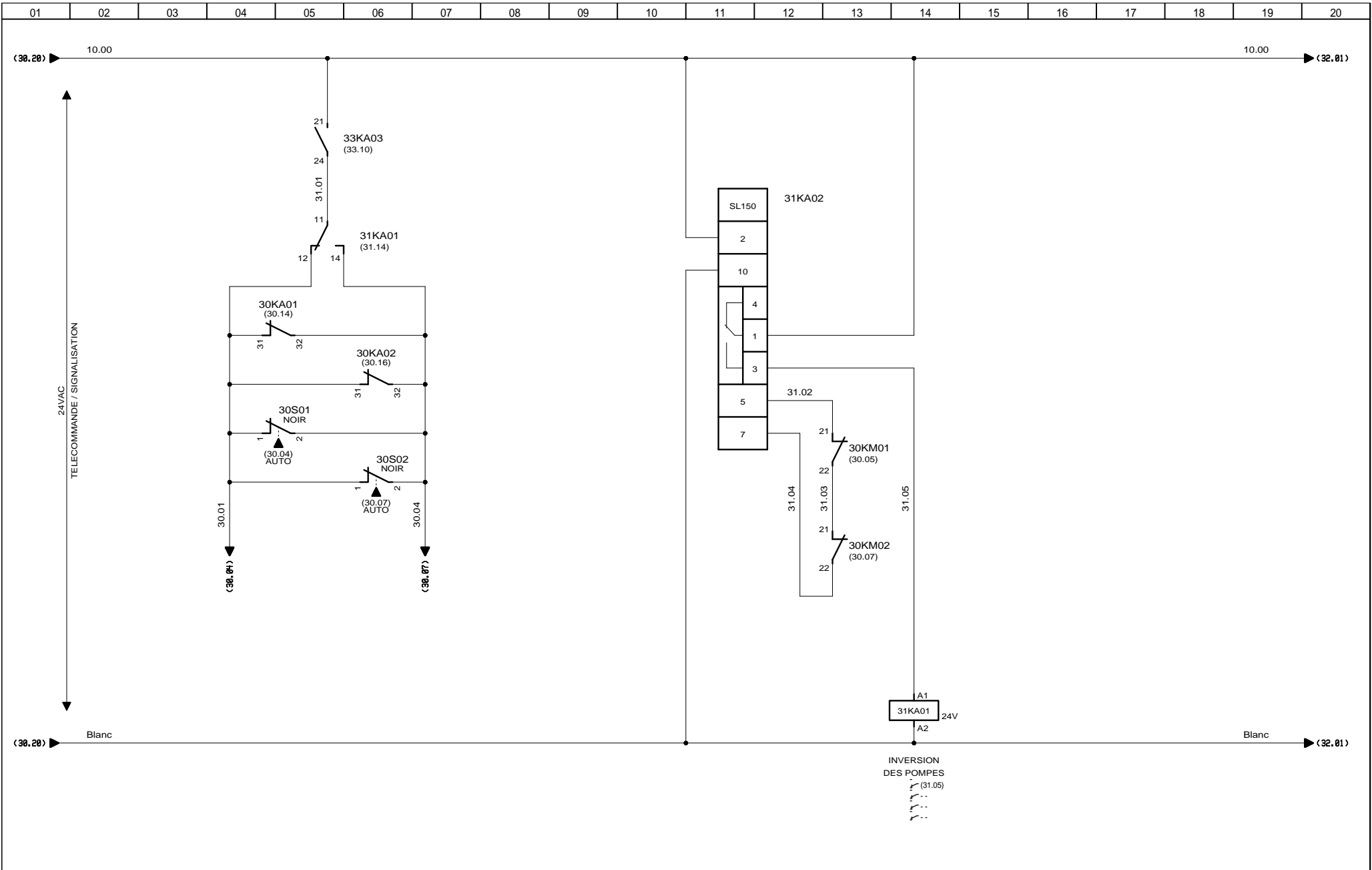
CLIENT ET NOM DU DOSSIER / CUSTOMER AND NAME OF FOLDER		INDICE / REVIEW
SAUR		0
Coffret Orconte		
DESSINATEUR / DRAWER	F.CO.	
N° AFFAIRE / N° PROJECT	170415	FOLIO/SHEET 30 / 31
		IGE-XAO VAR2 SERVICE PACK 9 - (L49.A)





 3, Rue Pierre Curie
 91230 MONTGERON
 Tél. : 01.69.52.47.00 - Fax : 01.69.52.47.01
 e-mail : seguin@automatismes-seguin.fr
 http://www.automatismes-seguin.fr

TELECOMMANDE POMPES

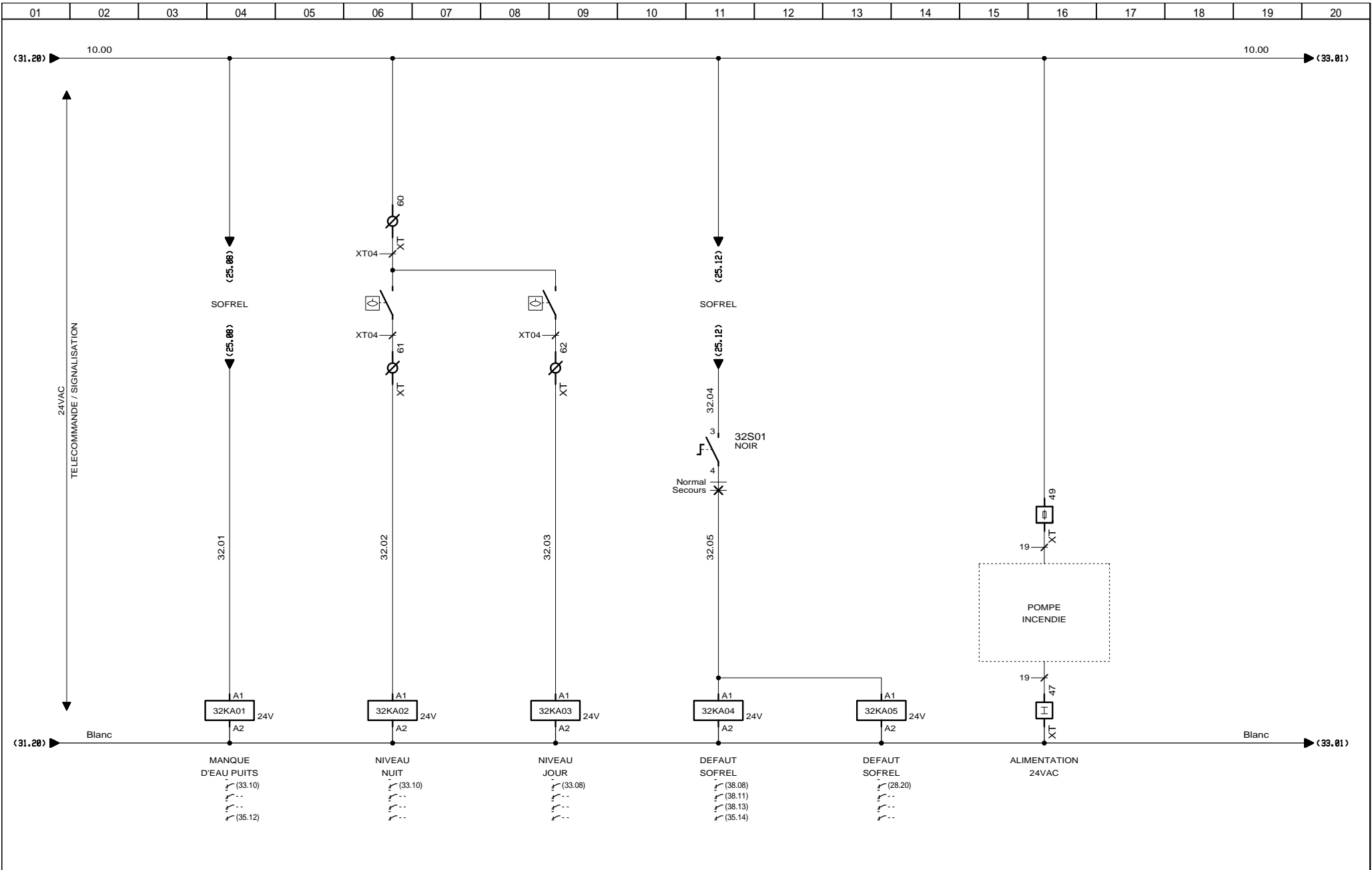
CLIENT ET NOM DU DOSSIER / CUSTOMER AND NAME OF FOLDER		INDICE / REVIEW
SAUR Coffret Orconte		0
DESSINATEUR DRAWER	F.CO.	 <small>VARI SERVICE PACK 9 - (L49A)</small>
N° AFFAIRE N° PROJECT	170415	
FOLIO/SHEET		31 / 32

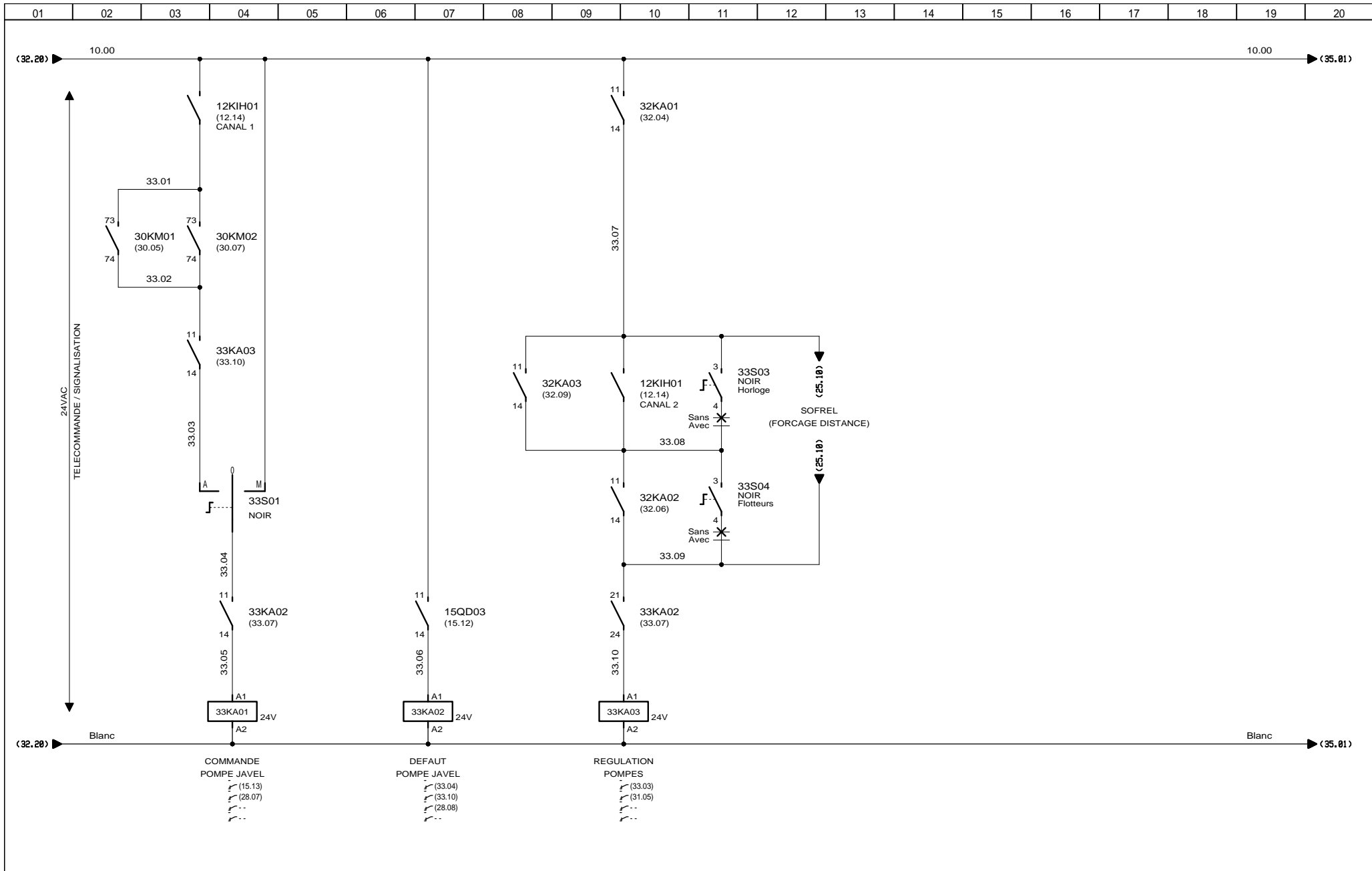

TELECOMMANDE NIVEAUX



3, Rue Pierre Curie
91230 MONTGERON
Tél. : 01.69.52.47.00 - Fax : 01.69.52.47.01
e-mail : seguin@automatismes-seguin.fr
http://www.automatismes-seguin.fr

TELECOMMANDE

CLIENT ET NOM DU DOSSIER / CUSTOMER AND NAME OF FOLDER		INDICE / REVIEW
SAUR Coffret Orconte		0
DESSINATEUR DRAWER	M.H.	IGE XAO
N° AFFAIRE N° PROJECT	170415	
FOLIO/SHEET 33 / 35		VAR2 SERVICE PACK 9 - (L4.49.A)

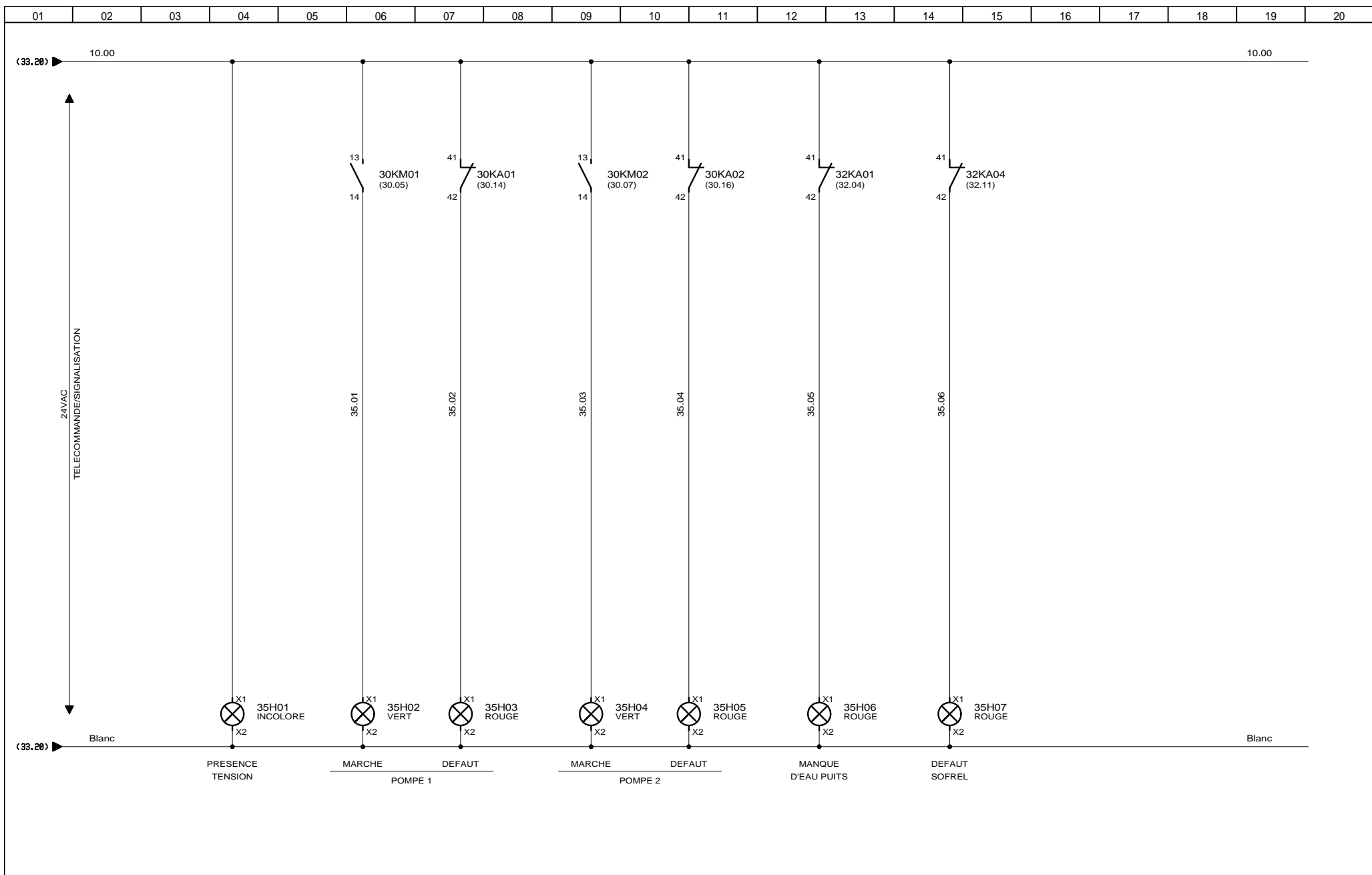

3, Rue Pierre Curie
91230 MONTGERON
Tél. : 01.69.52.47.00 - Fax : 01.69.52.47.01
e-mail : seguin@automatismes-seguin.fr
<http://www.automatismes-seguin.fr>

SIGNALISATION

CLIENT ET NOM DU DOSSIER / CUSTOMER AND NAME OF FOLDER		INDICE / REVIEW
SAUR Coffret Orconte		0
DESSINATEUR DRAWER	M.H.	FOLIO/SHEET 35 / 38
N° AFFAIRE N° PROJECT	170415	
		IGE-XAO VAR2 SERVICE PACK 9 - (L49A)

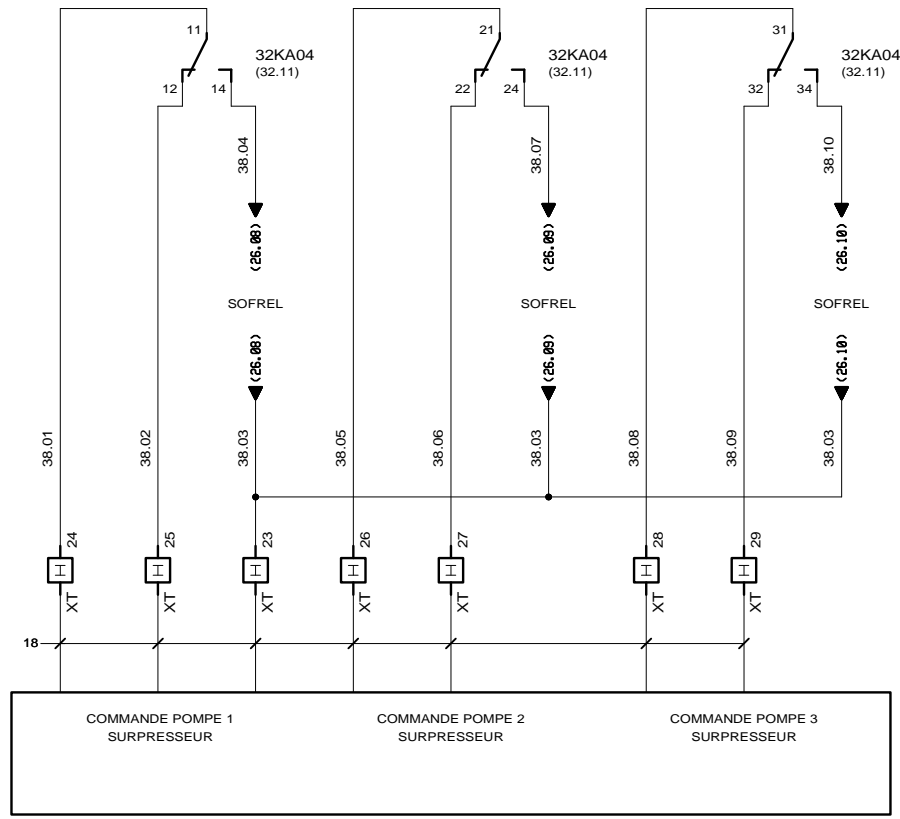

REPORTS

CLIENT ET NOM DU DOSSIER / CUSTOMER AND NAME OF FOLDER		INDICE / REVIEW
SAUR Coffret Orconte		0
DESSINATEUR DRAWER	M.H.	FOLIO/SHEET 38 / 40
N° AFFAIRE N° PROJECT	170415	
		 <small>VAR2 SERVICE PACK 9 - (L49A)</small>

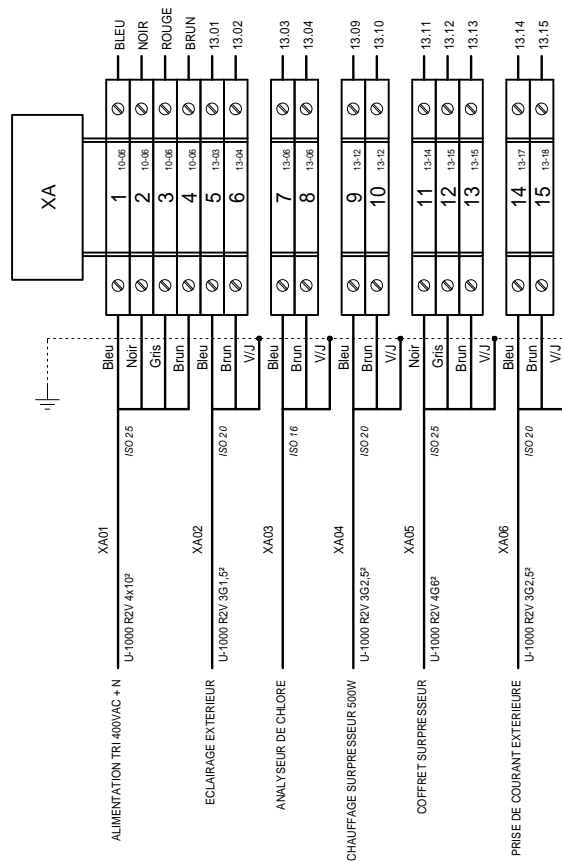

BORNIER XA ALIMENTATION

CLIENT ET NOM DU DOSSIER / CUSTOMER AND NAME OF FOLDER		INDICE / REVIEW
SAUR Coffret Orconte		0
DESSINATEUR DRAWER	M.H.	 FOLIO/SHEET 40 / 41 <small>VARI SERVICE PACK 9 - (L49A)</small>
N° AFFAIRE N° PROJECT	170415	

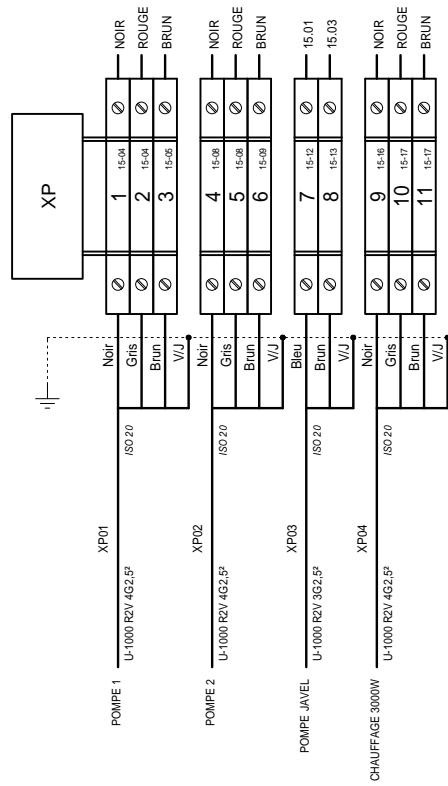

3, Rue Pierre Curie
91230 MONTGERON
Tél. : 01.69.52.47.00 - Fax : 01.69.52.47.01
e-mail : seguin@automatismes-seguin.fr
http://www.automatismes-seguin.fr

BORNIER XP PUISSANCE

CLIENT ET NOM DU DOSSIER / CUSTOMER AND NAME OF FOLDER		INDICE / REVIEW
SAUR Coffret Orconte		0
DESSINATEUR DRAWER	F.CO.	
N° AFFAIRE N° PROJECT	170415	
FOLIO/SHEET 41 / 42		VAR2 SERVICE PACK 9 - (L49A)

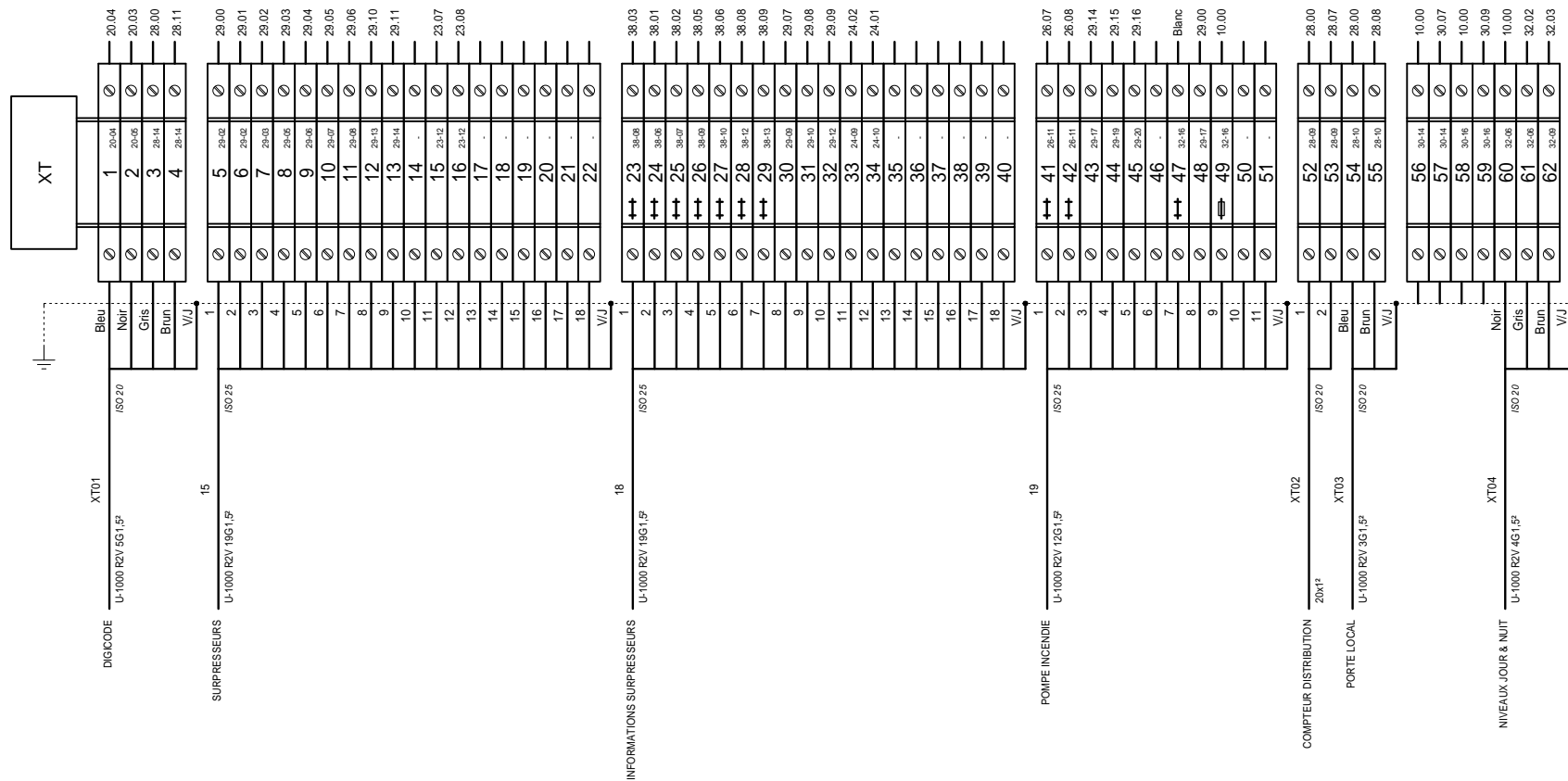

3, Rue Pierre Curie
91230 MONTGERON
Tél. : 01.69.52.47.00 - Fax : 01.69.52.47.01
e-mail : seguin@automatismes-seguin.fr
http://www.automatismes-seguin.fr

BORNIER XT TELECOMMANDE

CLIENT ET NOM DU DOSSIER / CUSTOMER AND NAME OF FOLDER		INDICE / REVIEW
SAUR Coffret Orconte		0
DESSINATEUR DRAWER	F.CO.	
N° AFFAIRE N° PROJECT	170415	
FOLIO/SHEET		42 / 43
VAR2 SERVICE PACK 9 - (L49A)		

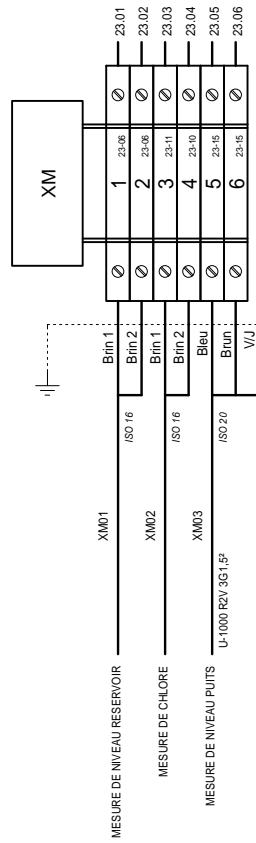

3, Rue Pierre Curie
 91230 MONTGERON
 Tél. : 01.69.52.47.00 - Fax : 01.69.52.47.01
 e-mail : seguin@automatismes-seguin.fr
 http://www.automatismes-seguin.fr

BORNIER XM MESURE

CLIENT ET NOM DU DOSSIER / CUSTOMER AND NAME OF FOLDER		INDICE / REVIEW
SAUR Coffret Orconte		0
DESSINATEUR DRAWER	M.H.	FOLIO/SHEET 43 / 50
N° AFFAIRE N° PROJECT	170415	
		IGE XAO VAR2 SERVICE PACK 9 - (L49A)

REPERE	DESIGNATION	REFERENCE	MARQUE	QTE
TOLERIE	COFFRET UNIVERSEL AVEC PORTE PLEINE SANS CHASSIS 1000x800x300, IP66, RAL7035	NSYS3D10830	SCHNEIDER ELECTRIC	1
	BOITIER DE TELEREPORT COULEUR GRISE	0180039	CAHORS	1
	POCHETTE OUVERTE POUR PLANS AUTOCOLLANTE, 340x235mm (ACC D'ENVELOPPES)	036580	LEGRAND	1
	TABLEAU DE COMPTAGE TRI + NEUTRE AVEC CCPI SANS AGCP 830x250	48030	SEIFEL	1
	POIGNEE A CLE 1242E	NSYAEDL1242S3D	SCHNEIDER ELECTRIC	1
10E01	REPARTITEUR TETRAPOLAIRE TD 40 A, 12 CONNEXIONS	563740	ERICO	1
10E02	BARRETTE DE COUPURE BASSE, PLATINE PLASTIQUE 95x20mm, L = 125mm	034389	LEGRAND	1
10KA01	RELAIS INDUSTRIEL EMBROCHABLE, MONOSTABLE, 4INV, 230VAC + EMBASE	RMIA45230AC + ZMI4SA	CARLO GAVAZZI	1
10PF01	RELAIS DE CONTROLE TRIPHASE POUR L'ORDRE ET LA PERTE DE PHASES, 208-480VAC, 1INV	DPA51CM44	CARLO GAVAZZI	1
10QD01	DISJONCTEUR IC60N 4P 1A, 440VAC/25kA, 250VDC/6kA, COURBE C	A9F74401	SCHNEIDER ELECTRIC	1
10QD02	DISJONCTEUR IC60N 2P 2A, 440VAC/25kA, 133VDC/6kA, COURBE C	A9F74202	SCHNEIDER ELECTRIC	1
10QD03	DISJONCTEUR DT40 1P+N 4A 6kA, COURBE C	A9N21022	SCHNEIDER ELECTRIC	1
10QIG01	INTERRUPTEUR DIFFERENTIEL IID TYPE AC 415VAC 4P 40A 300mA	A9R14440	SCHNEIDER ELECTRIC	1
10TR01	TRANSFORMATEUR DE COMMANDE ET DE SIGNALISATION MONOPHASEE 230-400V/24-48V, 100VA	044233	LEGRAND	1
12ECH01	RESISTANCE CHAUFFANTE PTC CSK 060, 120-240V AC/DC, 20W	06030.0-00	STEGO	1
12ECL01	LAMPE RENTABLE 8W 220V 50-60Hz 400lm	NSYLAM8T5	SCHNEIDER ELECTRIC	1
12KIH01	INTERRUPTEUR HORAIRE PROGRAMMABLE MULTIFONCTION DIGITAL LEXIC, 230VAC, 2 SORTIES 16A, 2 MODULES	412641	LEGRAND	1
12KTH01	PETIT THERMOSTAT KTO 011, 1NF, 0..60°C	01146.9-00	STEGO	1
12QD01	DISJONCTEUR DT40 VIGI 1P+N CLASSE AC 16A 30mA COURBE C	A9N21444	SCHNEIDER ELECTRIC	1
12QD02	DISJONCTEUR DT40 1P+N 1A 6kA, COURBE C	A9N21019	SCHNEIDER ELECTRIC	1
12QD03	DISJONCTEUR DT40 1P+N 2A 6kA, COURBE C	A9N21020	SCHNEIDER ELECTRIC	1
12QD04	DISJONCTEUR DT40 1P+N 2A 6kA, COURBE C	A9N21020	SCHNEIDER ELECTRIC	1
12S01	INTERRUPTEUR DE POSITION 1NO+1NF RB, M12 POUSSOIR A GALET, 1m CABLE	XCMD21F2L1	SCHNEIDER ELECTRIC	1
12X01	PRISE DE COURANT 2P+T 10/16A, 250VAC A ECLIPS	004280	LEGRAND	1
12X02	SOCLE DE TABLEAU 2P+T 16A, 200/250VAC	053903	LEGRAND	1
13KM01	CONTACTEUR DE PUISSANCE 9A 1NO+1NF 230V 50/60Hz	LC1D09P7	SCHNEIDER ELECTRIC	1
13KTH01	THERMOSTAT ELECTRONIQUE TH, PLAGES DE REGLAGE +5...+30C, ALIM. 250VAC	15870	SCHNEIDER ELECTRIC	1
13QD01	DISJONCTEUR DT40 1P+N 10A 6kA COURBE C	A9N21024	SCHNEIDER ELECTRIC	1
13QD02	DISJONCTEUR DT40 1P+N 10A 6kA COURBE C	A9N21024	SCHNEIDER ELECTRIC	1
13QD03	DISJONCTEUR DT40 1P+N 1A 6kA, COURBE C	A9N21019	SCHNEIDER ELECTRIC	1
13QD04	DISJONCTEUR DT40 1P+N 10A 6kA COURBE C	A9N21024	SCHNEIDER ELECTRIC	1
13QD05	DISJONCTEUR DT40 3P 25A 6kA COURBE C	A9N21047	SCHNEIDER ELECTRIC	1
13QD06	DISJONCTEUR DT40 VIGI 1P+N CLASSE AC 16A 30mA COURBE C	A9N21444	SCHNEIDER ELECTRIC	1
13S02	TETE BOUTON TOURNANT 2 POSITIONS	ZB4BD2	SCHNEIDER ELECTRIC	1
	CORPS CONTACT NO	ZB4BZ101	SCHNEIDER ELECTRIC	1
15PA01	AMPEREMETRE ROTEX R72A90-A, 0-25A-125A DIRECT DEV. 90D	192D1303	SOCOMEK	1
	2 CAPUCHONS	192Z1016	SOCOMEK	1
15PA02	AMPEREMETRE ROTEX R72A90-A, 0-25A-125A DIRECT DEV. 90D	192D1303	SOCOMEK	1
	2 CAPUCHONS	192Z1016	SOCOMEK	1
15QD01	DISJONCTEUR MOTEUR MAGNETO-THERMIQUE 9-14A, BORNES A VIS	GV2ME16	SCHNEIDER ELECTRIC	1
	ADDITIF FRONTAL F+O	GVAE11	SCHNEIDER ELECTRIC	1
15QD02	DISJONCTEUR MOTEUR MAGNETO-THERMIQUE 13-18A, BORNES A VIS	GV2ME20	SCHNEIDER ELECTRIC	1
	ADDITIF FRONTAL F+O	GVAE11	SCHNEIDER ELECTRIC	1
15QD03	DISJONCTEUR DT40 1P+N 2A 6kA, COURBE C	A9N21020	SCHNEIDER ELECTRIC	1
	BLOC VIGI DT40 1P+N CLASSE AC 25A 30mA 230VAC	A9N21450	SCHNEIDER ELECTRIC	1
	CONTACT OF + SD/OF 3A SOUS 415VAC/6A SOUS 240V AC	A9N26929	SCHNEIDER ELECTRIC	1
15QD04	DISJONCTEUR DT40 3P 10A 6kA COURBE C	A9N21044	SCHNEIDER ELECTRIC	1



3, Rue Pierre Curie
91230 MONTGERON
Tél. : 01.69.52.47.00 - Fax : 01.69.52.47.01
e-mail : seguin@automatismes-seguin.fr
http://www.automatismes-seguin.fr

NOMENCLATURE

CLIENT ET NOM DU DOSSIER / CUSTOMER AND NAME OF FOLDER		INDICE / REVIEW
SAUR		0
Coffret Orconte		
DESSINATEUR DRAWER	F.CO.	FOLIO/SHEET 50 / 51
N° AFFAIRE N° PROJECT	170415	
		IGE XAO VARD SERVICE PACK 9 - (L49A)

REPERE	DESIGNATION	REFERENCE	MARQUE	QTE
20E01	RACK S550 8 EMPLACEMENTS AVEC ALIM SECTEUR 230VAC	T9950A100	SOFREL	1
20E01-01	MODULE DE COMMUNICATION PSTN (RTC) 33.600 bps	V5900510	SOFREL	1
20E01-03	MODULE D'ENTREES, 4E ANA MULTISTANDARD	V5900250	SOFREL	1
20E01-04	MODULE D'ENTREES, 4E ANA MULTISTANDARD	V5900250	SOFREL	1
20E01-05	MODULE DE SORTIES, 4S TOR 1S TOR WDG 50V 1A	V5900310	SOFREL	1
20E01-06	MODULE DE SORTIES, 4S TOR 1S TOR WDG 50V 1A	V5900310	SOFREL	1
20E01-07	MODULE DE SORTIES, 4S ANA 0/4-20mA 0-10V	V5900350	SOFREL	1
20FP01	PROTECTION SECTEUR 230V, 5kA, Up=1.2kV	T5300011	SOFREL	1
20FP02	PROTECTION RTC	T5300012	SOFREL	1
20G01	BATTERIE 12V, 7Ah	NP7-12FR	YUASA	1
20QD01	DISJONCTEUR DT40 1P+N 4A 6kA, COURBE C	A9N21022	SCHNEIDER ELECTRIC	1
20X01	PRISE TELEPHONIQUE SAILLIE - 8 CONTACTS	051219	LEGRAND	1
21E01	MODULE D'ENTREES 16E TOR, EXTENSION I/O	V6900210	SOFREL	1
21E02	MODULE D'ENTREES 16E TOR, EXTENSION I/O	V6900210	SOFREL	1
28S01	TETE BOUTON TOURNANT 2 POSITIONS A SERRURE AVEC CLE N°455	ZB4BG2	SCHNEIDER ELECTRIC	1
	CORPS CONTACT NO	ZB4BZ101	SCHNEIDER ELECTRIC	1
30KA01	RELAIS INDUSTRIEL EMBROCHABLE, MONOSTABLE, 4INV, 24VAC + EMBASE	RMIA4524AC + ZMI4SA	CARLO GAVAZZI	1
30KA02	RELAIS INDUSTRIEL EMBROCHABLE, MONOSTABLE, 4INV, 24VAC + EMBASE	RMIA4524AC + ZMI4SA	CARLO GAVAZZI	1
30KM01	CONTACTEUR DE PUISSANCE 18A 1NO+1NF 24V 50/60Hz	LC1D18B7	SCHNEIDER ELECTRIC	1
	BLOC DE CONTACTS AUXILIAIRES 4NO FRONTAL	LADN40	SCHNEIDER ELECTRIC	1
30KM02	CONTACTEUR DE PUISSANCE 18A 1NO+1NF 24V 50/60Hz	LC1D18B7	SCHNEIDER ELECTRIC	1
	BLOC DE CONTACTS AUXILIAIRES 4NO FRONTAL	LADN40	SCHNEIDER ELECTRIC	1
30PCH01	COMPTEUR HORAIRE TOTALISATEUR 10...30V, 50Hz	3220401071	KUBLER	1
	CADRE POUR COMPTEUR DIN H57	BT008171	KUBLER	1
30PCH02	COMPTEUR HORAIRE TOTALISATEUR 10...30V, 50Hz	3220401071	KUBLER	1
	CADRE POUR COMPTEUR DIN H57	BT008171	KUBLER	1
30S01	TETE BOUTON TOURNANT 3 POSITIONS	ZB4BD3	SCHNEIDER ELECTRIC	1
	CORPS CONTACT 2NO	ZB4BZ103	SCHNEIDER ELECTRIC	1
	CONTACT VIS ETRIER 1NO	ZBE101	SCHNEIDER ELECTRIC	1
30S02	TETE BOUTON TOURNANT 3 POSITIONS	ZB4BD3	SCHNEIDER ELECTRIC	1
	CORPS CONTACT 2NO	ZB4BZ103	SCHNEIDER ELECTRIC	1
	CONTACT VIS ETRIER 1NO	ZBE101	SCHNEIDER ELECTRIC	1
31KA01	RELAIS INDUSTRIEL EMBROCHABLE, MONOSTABLE, 4INV, 24VAC + EMBASE	RMIA4524AC + ZMI4SA	CARLO GAVAZZI	1
31KA02	RELAIS PERMUTATION FLIP FLOP 24VAC + EMBASE DE RELAIS DETECTEUR DE NIVEAUX S 196 + ETRIER	SL150024 + 9399020101 + HF	CARLO GAVAZZI	1
32KA01	RELAIS INDUSTRIEL EMBROCHABLE, MONOSTABLE, 4INV, 24VAC + EMBASE	RMIA4524AC + ZMI4SA	CARLO GAVAZZI	1
32KA02	RELAIS INDUSTRIEL EMBROCHABLE, MONOSTABLE, 4INV, 24VAC + EMBASE	RMIA4524AC + ZMI4SA	CARLO GAVAZZI	1
32KA03	RELAIS INDUSTRIEL EMBROCHABLE, MONOSTABLE, 4INV, 24VAC + EMBASE	RMIA4524AC + ZMI4SA	CARLO GAVAZZI	1
32KA04	RELAIS INDUSTRIEL EMBROCHABLE, MONOSTABLE, 4INV, 24VAC + EMBASE	RMIA4524AC + ZMI4SA	CARLO GAVAZZI	1
32KA05	RELAIS INDUSTRIEL EMBROCHABLE, MONOSTABLE, 4INV, 24VAC + EMBASE	RMIA4524AC + ZMI4SA	CARLO GAVAZZI	1
32S01	TETE BOUTON TOURNANT 2 POSITIONS	ZB4BD2	SCHNEIDER ELECTRIC	1
	CORPS CONTACT NO	ZB4BZ101	SCHNEIDER ELECTRIC	1
33KA01	RELAIS INDUSTRIEL EMBROCHABLE, MONOSTABLE, 4INV, 24VAC + EMBASE	RMIA4524AC + ZMI4SA	CARLO GAVAZZI	1
33KA02	RELAIS INDUSTRIEL EMBROCHABLE, MONOSTABLE, 4INV, 24VAC + EMBASE	RMIA4524AC + ZMI4SA	CARLO GAVAZZI	1
33KA03	RELAIS INDUSTRIEL EMBROCHABLE, MONOSTABLE, 4INV, 24VAC + EMBASE	RMIA4524AC + ZMI4SA	CARLO GAVAZZI	1
33S01	TETE BOUTON TOURNANT 3 POSITIONS	ZB4BD3	SCHNEIDER ELECTRIC	1
	CORPS CONTACT 2NO	ZB4BZ103	SCHNEIDER ELECTRIC	1
33S03	TETE BOUTON TOURNANT 2 POSITIONS	ZB4BD2	SCHNEIDER ELECTRIC	1



3, Rue Pierre Curie
91230 MONTGERON
Tél. : 01.69.52.47.00 - Fax : 01.69.52.47.01
e-mail : seguin@automatismes-seguin.fr
http://www.automatismes-seguin.fr

NOMENCLATURE

CLIENT ET NOM DU DOSSIER / CUSTOMER AND NAME OF FOLDER			INDICE / REVIEW
SAUR Coffret Orconte			0
DESSINATEUR DRAWER	F.CO.	FOLIO/SHEET	51 / 52
N° AFFAIRE N° PROJECT	170415	VARD SERVICE PACK 9 - (L149A)	

