

LETTRE DE REPERAGE DES ELEMENTS DU SCHEMA

QI	INTERRUPTEUR	PCPI	CONTROLEUR D'ISOLEMENT	KT	RELAIS TEMPORISE	SA	COMMUTATEUR D'AMPEREMETRE
QIG	INTERRUPTEUR GENERAL	TR	TRANSFORMATEUR DE TENSION	KAU	RELAIS ARRÊT D'URGENCE	SV	COMMUTATEUR DE VOLTMETRE
QD	DISJONCTEUR	TC	TRANSFORMATEUR DE COURANT	UF	VARIATEUR	ECH	RESISTANCE CHAUFFANTE
QDG	DISJONCTEUR GENERAL	U	ONDULEUR, ALIMENTATION	UM	DEMARREUR	ECL	ECLAIRAGE
FP	PARAFONDRE	KIC	INTER CREPUSCULAIRE	S	ORGANE DE COMMANDE	G	BATTERIE
FU	FUSIBLE	KIH	HORLOGE	H	VOYANT, SIRENE	P	INSTRUMENTATION
F	THERMIQUE	KTH	THERMOSTAT	PCH	COMPTEUR HORAIRE	X	PRISE DE COURANT, BORNIER
QF	SECTIONNEUR FUSIBLE	KM	CONTACTEUR	PA	AMPEREMETRE	E	MATERIELS AUTRES
PF	CONTROLEUR DE PHASE	KA	RELAIS	PV	VOLTMETRE	KTL	TELERUPTEUR

LETTER CODES FOR ITEMS DESIGNATION ON THE DRAWING

QI	SWITCH	PCPI	INSULATION CONTROLLER	KT	TEMPORIZES RELAY	SA	AMPEREMETER SWITCH
QIG	GENERAL SWITCH	TR	TENSION TRANSFORMER	KAU	EMERGENCY STOP RELAY	SV	VOLTMETER SWITCH
QD	BREAKER	TC	CURRENT TRANSFORMER	UF	VELOCITY VARIATOR	ECL	LIGHT
QDG	GENERAL BREAKER	U	INVERTER, SUPPLY	UM	MOTOR STARTER	ECH	HEATER
FP	LIGHTNING PROTECTOR	KIC	DIMMER	S	CONTROL UNIT	G	BATTERY
FU	FUSE	KIH	CLOCK	H	INDICATOR	P	INSTRUMENTATION
F	THERMAL RELAY	KTH	THERMOSTAT	PCH	TIMER	X	SOCKET, TERMINAL BLOCK
QF	DISCONNECTING SWITCH	KM	CONTACTOR	PA	AMPEREMETER	E	OTHER EQUIPMENTS
PF	PHASE CONTROLLER	KA	RELAY	PV	VOLTMETER	KTL	TELEBREAKER

COULEURS DE FILS

TRI 400V: <= 6 mm2 Noir Rouge Brun
> 6 mm2 Noir Bagué Noir Rouge Brun

NEUTRE: Bleu Clair

230VAC: Rouge avec Commun Bobines Blanc (*)

230VAC ONDULE: Neutre Bleu Clair Bagué Orange
Phase Noir Bagué Orange

110VAC: Noir avec Commun Bobines Blanc (*)

24VAC: Violet avec Commun Bobines Blanc (*)

24VDC: Bleu Foncé avec Commun Bobines Blanc (*)

48VAC: Violet avec Commun Bobines Blanc (*)

48VDC: Bleu Foncé avec Commun Bobines Blanc (*)

REPORTS: Orange

TERRE: Vert/Jaune

ANALOGIQUE: Une Paire + Brun - Blanc
Unifilaire Blanc

TENSION EXTERNE PERMANENTE INTER GENERAL OUVERT: Orange

ATTENTION

Si plusieurs tensions de télécommande, alors prendre uniquement le 230VAC avec Commun Bobines Blanc

(*) Si Télécommande

WIRE COLOR

TRI 400V: <= 6 mm2 Black Red Brown
> 6 mm2 Black with Ring Black Red Brown

NEUTRE: Light Blue

230VAC: Red with Spods Common White (*)

230VAC UPS: Neutre Light Blue with Ring Orange
Phase Black with Ring Orange

110VAC: Black with Spods Common White (*)

24VAC: Purple with Spods Common White (*)

24VDC: Dark Bleu with Spods Common White (*)

48VAC: Purple with Spods Common White (*)

48VDC: Dark Bleu with Spods Common White (*)

REPORTS: Orange

GROUND: Green/Yellow

ANALOGICAL: One Pair + Brown - White
Unifilar White

PERMANENTLY EXTERNAL POWER GENERAL BREAKER OPEN: Orange

CAUTION

If There are Several Tensions of Command Then to take Only the 230VAC with Spods Common White

(*) If Command

TYPE DE RELAIS ET DE CONTACT DANS LE SCHEMA

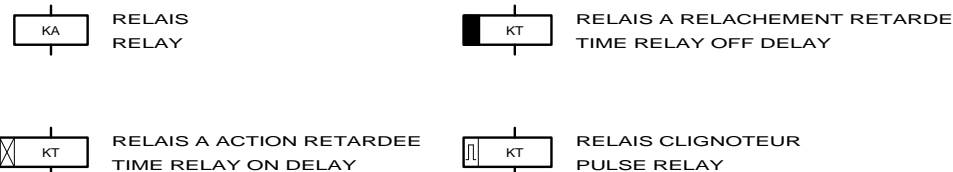

RELAY AND CONTACT TYPE IN THE DRAWING



LE SCHEMA EST REPRESENTÉ HORS TENSION ET GENERATEUR HORS SERVICE

THE DRAWING IS SHOWN OUT OF VOLTAGE AND WITH GENERATOR OUT OF SERVICE



3, Rue Pierre Curie
91230 MONTGERON
Tél. : 01.69.52.47.00 - Fax : 01.69.52.47.01
e-mail : seguin@automatismes-seguin.fr
http://www.automatismes-seguin.fr

LEGENDE DU SCHEMA ELECTRIQUE

CLIENT ET NOM DU DOSSIER / CUSTOMER AND NAME OF FOLDER		INDICE / REVIEW
SEGEX ENERGIES Armoire Commande		A
DESSINATEUR DRAWER	FOLIO/SHEET 03/04	IGE-XAO VARI SERVICE PACK 7A
N° AFFAIRE N° PROJECT		
170200.1		

CODE DU REPERAGE

LETTER CODE

1/ DES APPAREILS DANS LES ARMOIRES
APPARATUS IN THE CABINETS



EXEMPLE:KA RELAIS
EXAMPLE:KA RELAY

52 KA 01

N° D'ORDRE DANS LE FOLIO D'ORIGINE
ORDER NUMBER ON ORIGINAL SHEET

LETTRE DE REPERAGE
LETTER CODES FOR ITEM

N° DU FOLIO D'ORIGINE
ORIGINAL SHEET NUMBER

2/ DES FILS DE CABLAGE
WIRING

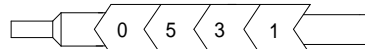

N° DU FOLIO D'ORIGINE
ORIGINAL SHEET NUMBER

N° DU FIL DANS LE FOLIO D'ORIGINE
NUMBER OF THE WIRE ON ORIGINAL SHEET

3/ REPORT DES CONTACTS DANS LE SCHEMA
CONTACT REPORT IN THE DRAWING



17.29

N° DE LA COLONNE OU EST UTILISE LE CONTACT
COLUMN NUMBER WHERE THE CONTACT IS USED

N° DU FOLIO OU EST UTILISE LE CONTACT
SHEET NUMBER WHERE THE CONTACT IS USED

4/ REPRESENTATION DES BORNES ET BORNIERES DANS LE SCHEMA
BINDINGS SCREWS VIEW IN THE DRAWING



N° D'ORDRE (SI NECESSAIRE)
ORDER NUMBER (IF NECESSARY)

NATURE DU BORNIER
NATURE OF TERMINAL BLOCK

A : ALIMENTATION
P : PUISSANCE
T : TELECOMMANDE
M : MESURE
R : REPORTS



LE SCHEMA EST REPRESENTE HORS TENSION ET GENERATEUR HORS SERVICE

THE DRAWING IS SHOWN OUT OF VOLTAGE AND WITH GENERATOR OUT OF SERVICE



3, Rue Pierre Curie
91230 MONTGERON
Tél. : 01.69.52.47.00 - Fax : 01.69.52.47.01
e-mail : seguin@automatismes-seguin.fr
http://www.automatismes-seguin.fr

LEGENDE DU SCHEMA ELECTRIQUE

CLIENT ET NOM DU DOSSIER / CUSTOMER AND NAME OF FOLDER		INDICE / REVIEW
SEGEX ENERGIES Armoire Commande		A
DESSINATEUR DRAWER	FOLIO/SHEET 04/05	IGE XAO VARI SERVICE PACK 7A
N° AFFAIRE N° PROJECT		
170200.1		

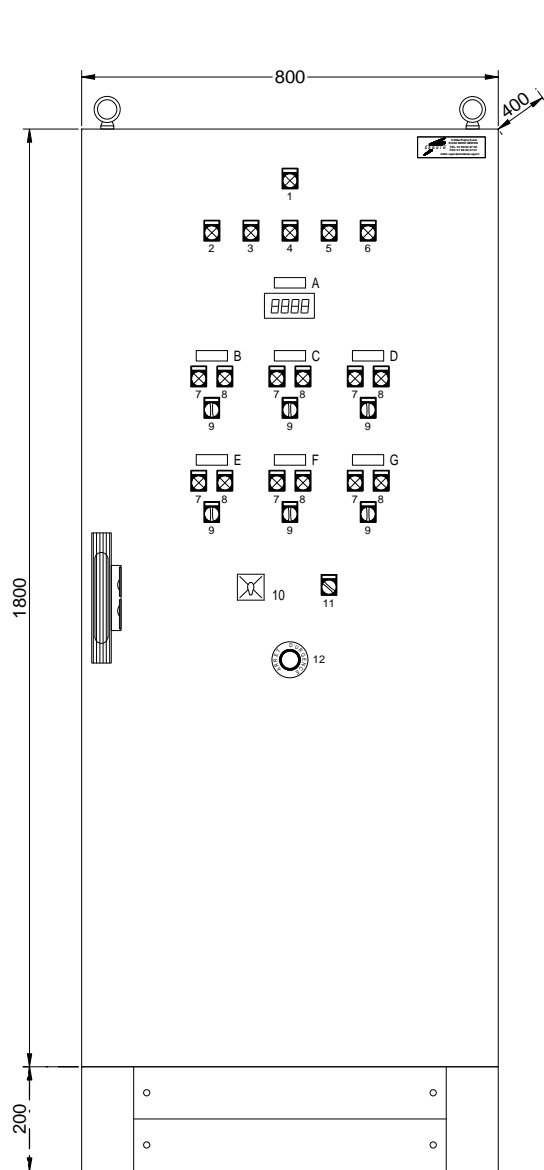

IMPLANTATION FACADE

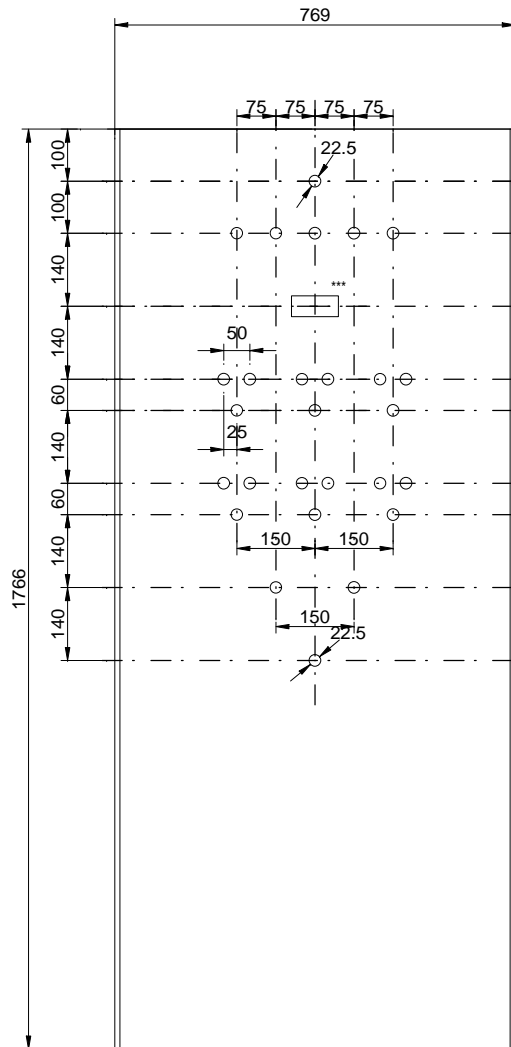

PLAN DE DECOUPE

ETIQUETTES 60x20

- A - ANEMOMETRE
- B - POMPE EFFETS D'EAU ZONE 1
- C - POMPE EFFETS D'EAU ZONE 2
- D - POMPE EFFETS D'EAU ZONE 3
- E - POMPE EFFETS D'EAU ZONE 4
- F - POMPE EFFETS D'EAU ZONE 5
- G - ECLAIRAGE FONTAINE

ETIQUETTES SCHNEIDER

- 1 - SOUS TENSION
- 2 - DEFAUT POMPE RELEVAGE LOCAL
- 3 - FILTRATION DISPONIBLE
- 4 - ADOUCISSEUR DISPONIBLE
- 5 - POMPE DOSEUSE DISPONIBLE
- 6 - EV REMPLISSAGE DISPONIBLE
- 7 - MARCHE
- 8 - DEFAUT
- 9 - AUTO / 0 / MAIN
- 10 - P1 / P2 / P3 / P4 / P5
- 11 - A / M GENERAL
- 12 - ARRET D'URGENCE



3, Rue Pierre Curie
91230 MONTGERON
Tél. : 01.69.52.47.00 - Fax : 01.69.52.47.01
e-mail : seguin@automatismes-seguin.fr
http://www.automatismes-seguin.fr

IMPLANTATION EXTERNE

CLIENT ET NOM DU DOSSIER / CUSTOMER AND NAME OF FOLDER			INDICE / REVIEW
SEGEX ENERGIES Armoire Commande			A
DESSINATEUR DRAWER	C.C.	FOLIO/SHEET	05 / 10
N° AFFAIRE N° PROJECT	170200.1		
			V4R1 SERVICE PACK 7A

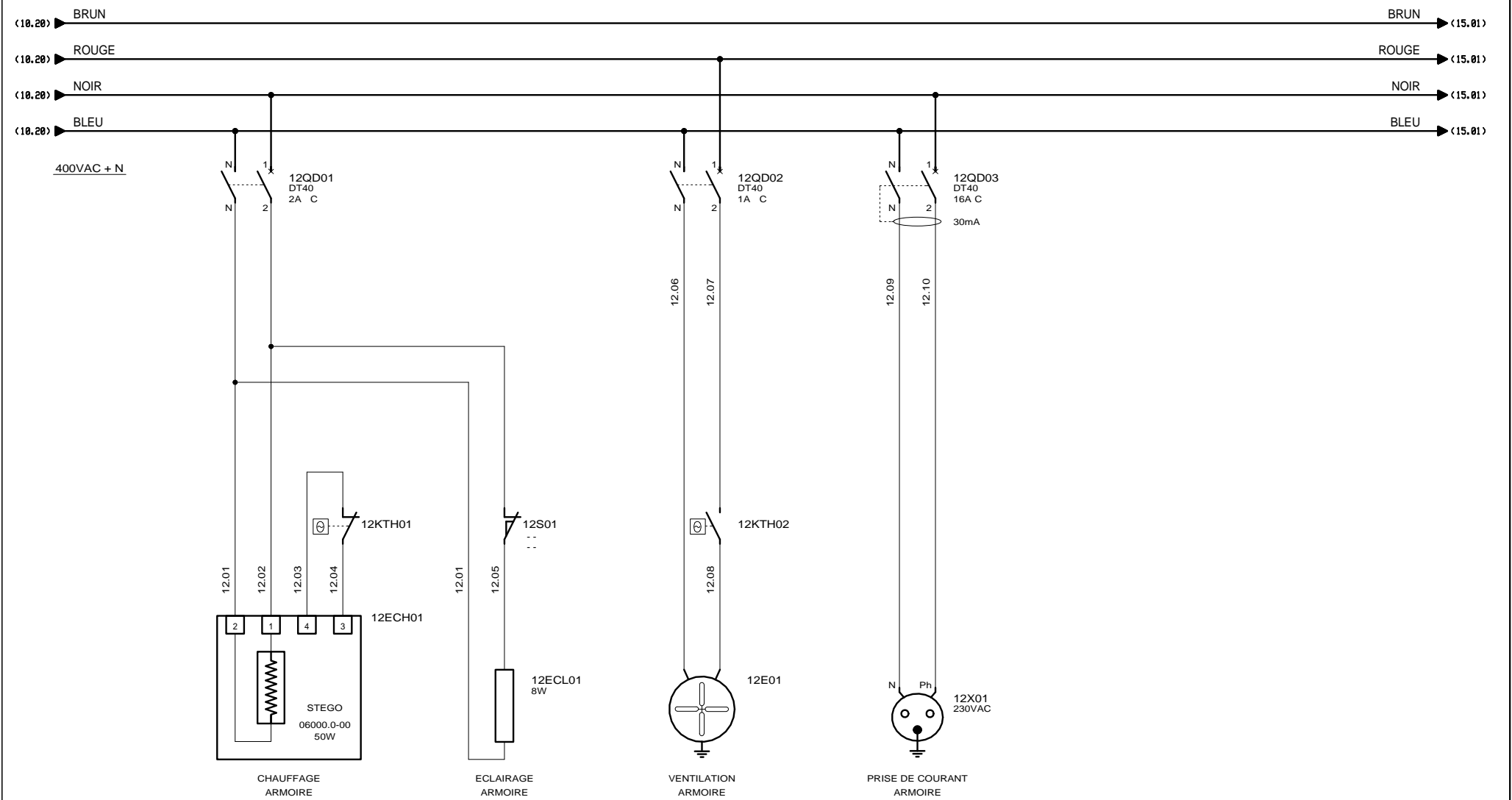



 3, Rue Pierre Curie
 91230 MONTGERON
 Tél. : 01.69.52.47.00 - Fax : 01.69.52.47.01
 e-mail : seguin@automatismes-seguin.fr
 http://www.automatismes-seguin.fr

UTILITES

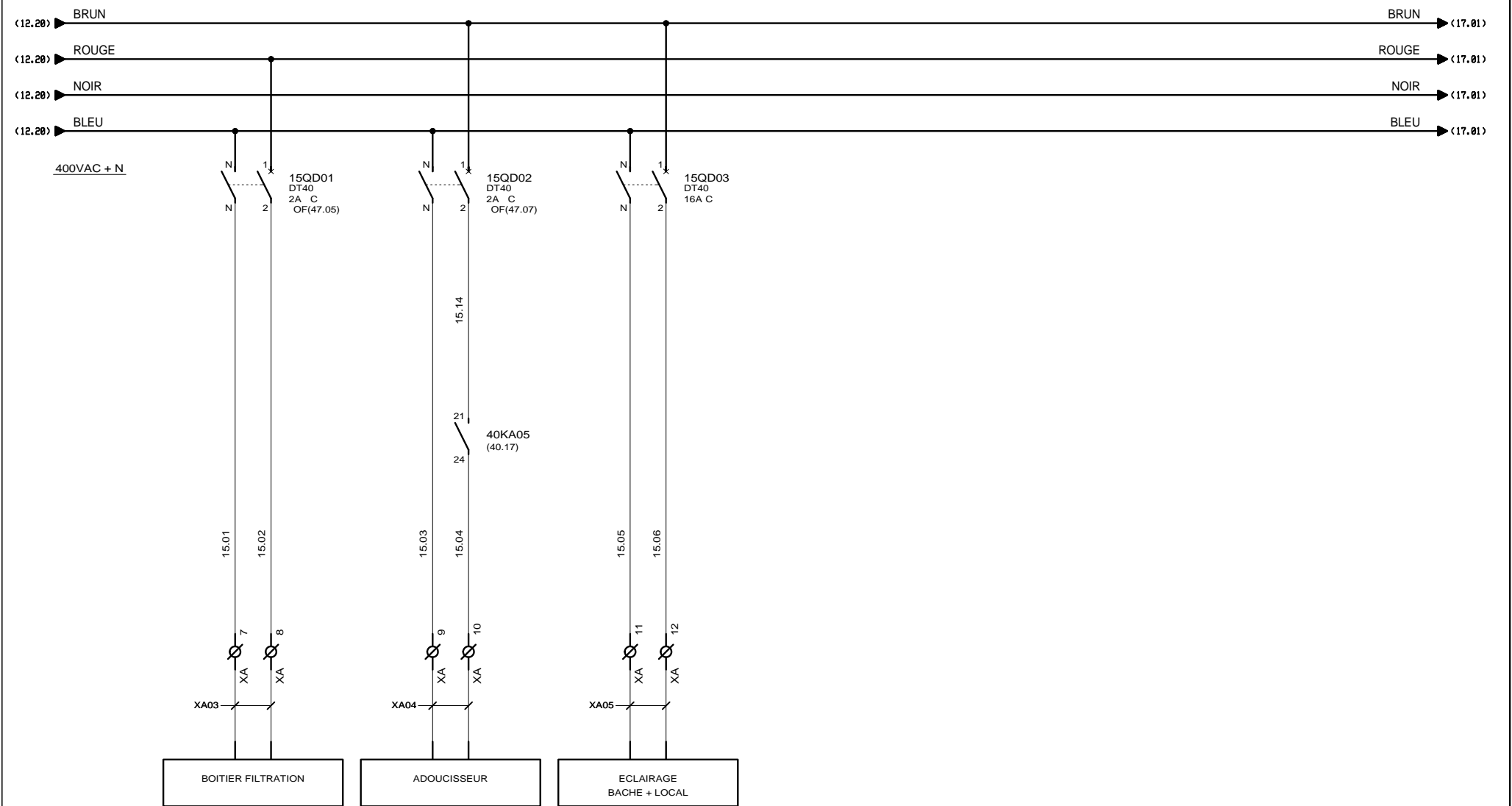
CLIENT ET NOM DU DOSSIER / CUSTOMER AND NAME OF FOLDER		INDICE / REVIEW
SEGEX ENERGIES		A
Armoire Commande		
DESSINATEUR / DRAWER	C.C.	FOLIO/SHEET 12 / 15
N° AFFAIRE / N° PROJECT	170200.1	
		VARI SERVICE PACK 7A





 3, Rue Pierre Curie
 91230 MONTGERON
 Tél. : 01.69.52.47.00 - Fax : 01.69.52.47.01
 e-mail : seguin@automatismes-seguin.fr
<http://www.automatismes-seguin.fr>

DISTRIBUTION 400VAC+N

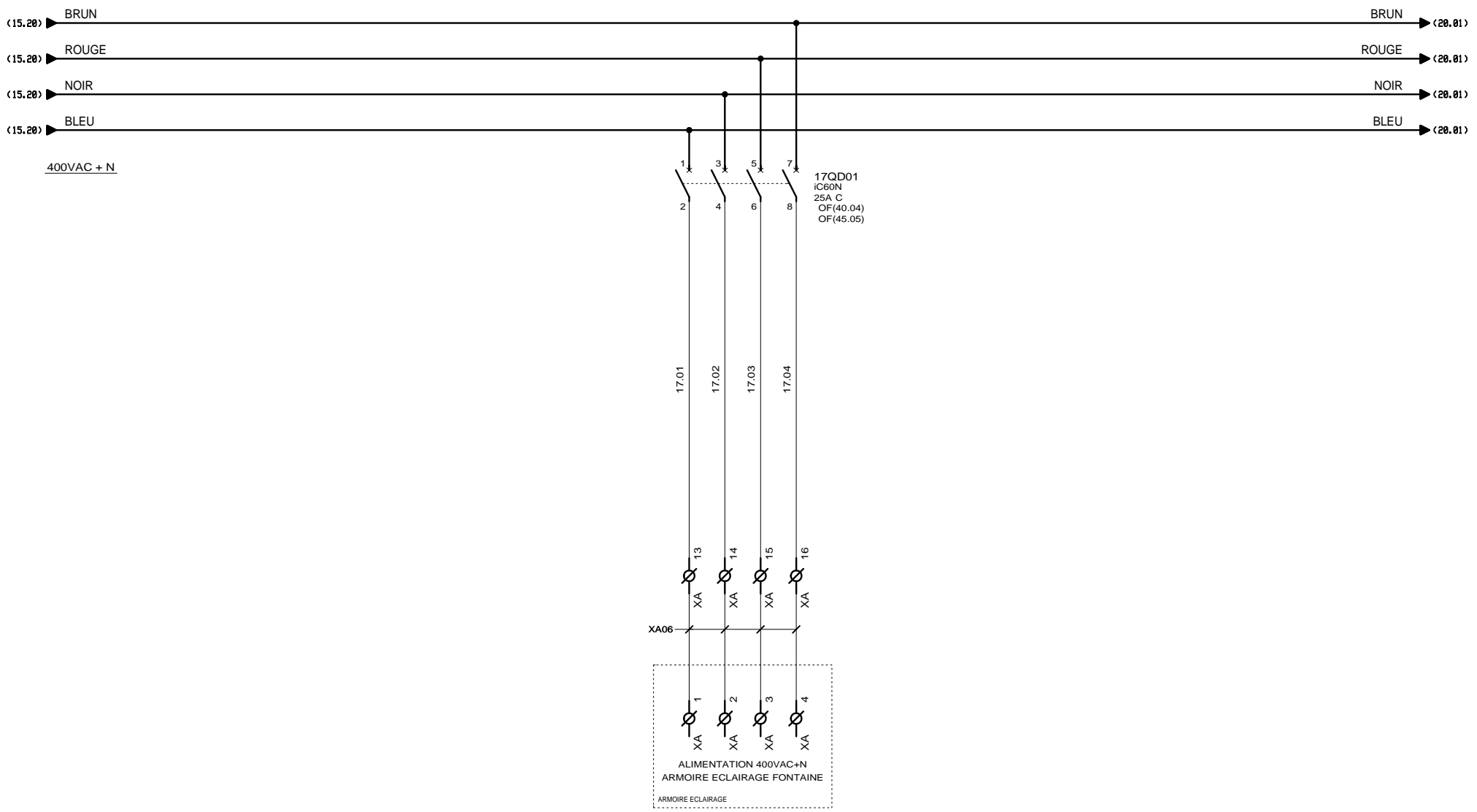
CLIENT ET NOM DU DOSSIER / CUSTOMER AND NAME OF FOLDER		INDICE / REVIEW
SEGEX ENERGIES		Δ
Armoire Commande		
DESSINATEUR DRAWER	C.C.	IGE XAO
N° AFFAIRE N° PROJECT	170200.1	FOLIO/SHEET 15 / 17
		VARI SERVICE PACK 7A



 3, Rue Pierre Curie
 91230 MONTGERON
 Tél. : 01.69.52.47.00 - Fax : 01.69.52.47.01
 e-mail : seguin@automatismes-seguin.fr
 http://www.automatismes-seguin.fr

DISTRIBUTION 400VAC+N

CLIENT ET NOM DU DOSSIER / CUSTOMER AND NAME OF FOLDER			INDICE / REVIEW
SEGEX ENERGIES			Δ
Armoire Commande			IGE-XAO
DESSINATEUR DRAWER	C.C.	FOLIO/SHEET	17 / 20
N° AFFAIRE N° PROJECT	170200.1	VARI SERVICE PACK 7A	

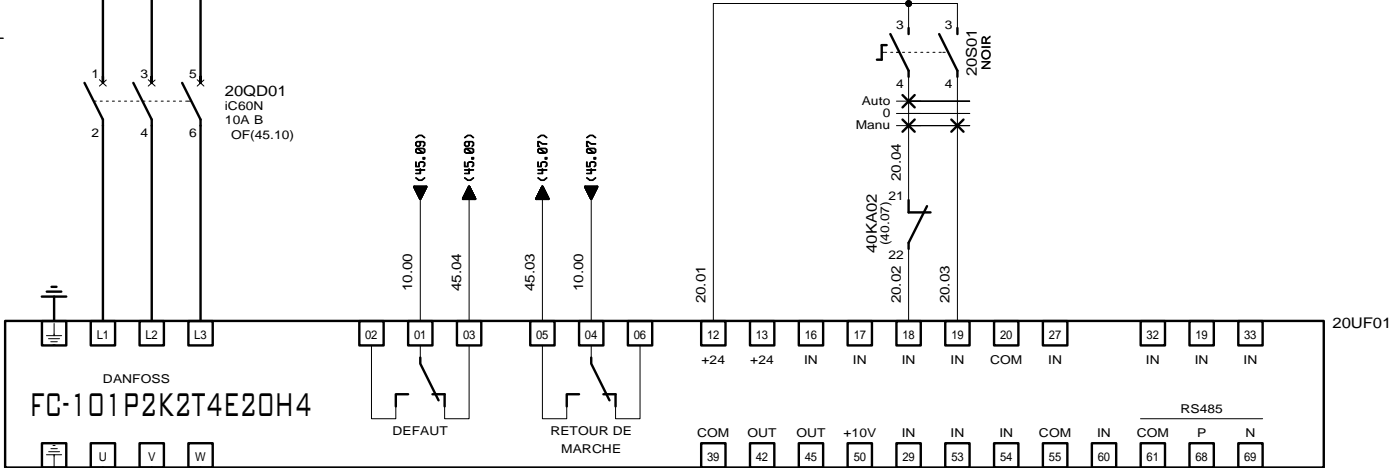
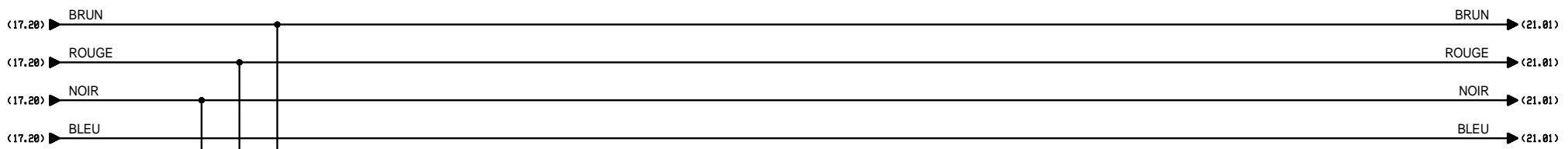

PARAMETRES
 Borne 18 = 8 (démarrage)
 Borne 19 = 16 (référence prédéfinie bit 0)

DANFOSS
FC-101P2K2T4E20H4

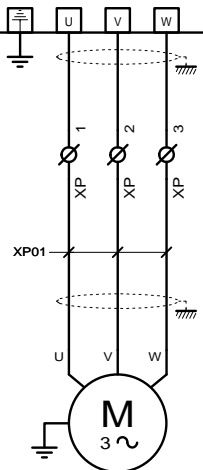

POMPE EFFETS D'EAU ZONE 1	
Pmax	2.2 kW
In	A

PUISSANCE
POMPE EFFETS D'EAU ZONE 1

CLIENT ET NOM DU DOSSIER / CUSTOMER AND NAME OF FOLDER		INDICE / REVIEW
SEGEX ENERGIES Armoire Commande		A
DESSINATEUR DRAWER	C.C.	FOLIO/SHEET 20/21
N° AFFAIRE N° PROJECT	170200.1	
		IGE XAO VARI SERVICE PACK 7A

AUTOMATISMES SEGUIN
 Systeme Qualité
 3, Rue Pierre Curie
 91230 MONTGERON
 Tél. : 01.69.52.47.00 - Fax : 01.69.52.47.01
 e-mail : seguin@automatismes-seguin.fr
 http://www.automatismes-seguin.fr

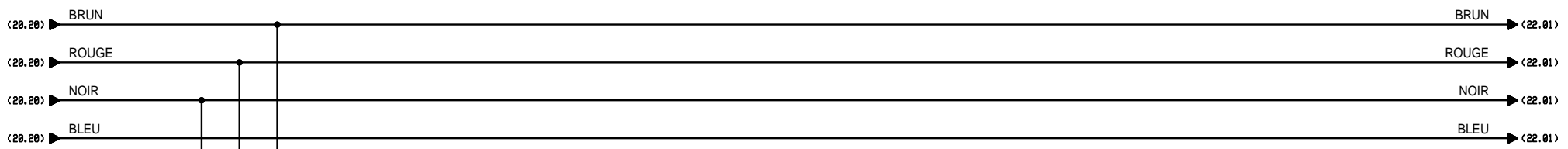

400VAC + N

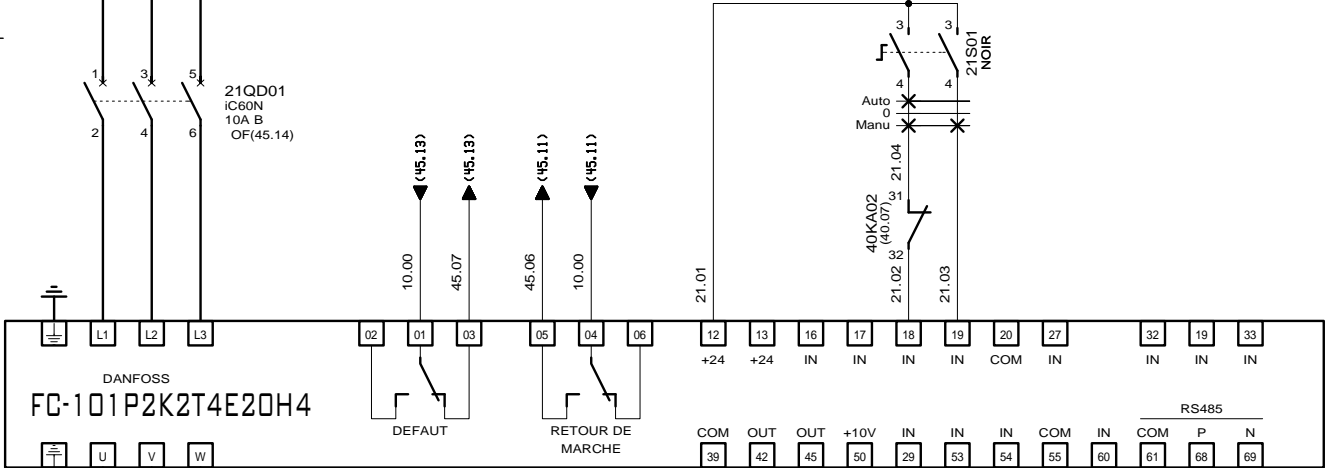

PARAMETRES
 Borne 18 = 8 (démarrage)
 Borne 19 = 16 (référence prédéfinie bit 0)

DANFOSS
FC-101P2K2T4E20H4

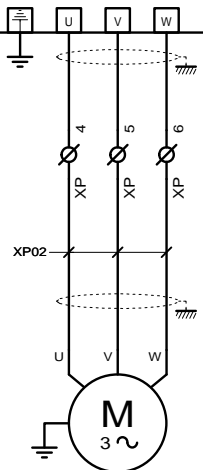

POMPE EFFETS D'EAU ZONE 2	
Pmax	2.2 kW
In	A

PUISSANCE
POMPE EFFETS D'EAU ZONE 2

AUTOMATISMES SEGUIN
 Systeme Qualité
 3, Rue Pierre Curie
 91230 MONTGERON
 Tél. : 01.69.52.47.00 - Fax : 01.69.52.47.01
 e-mail : seguin@automatismes-seguin.fr
 http://www.automatismes-seguin.fr

CLIENT ET NOM DU DOSSIER / CUSTOMER AND NAME OF FOLDER		INDICE / REVIEW
SEGEX ENERGIES		A
Armoire Commande		
DESSINATEUR / DRAWER	C.C.	IGE XAO
N° AFFAIRE / N° PROJECT	170200.1	
FOLIO/SHEET 21/22		VARI SERVICE PACK 7A

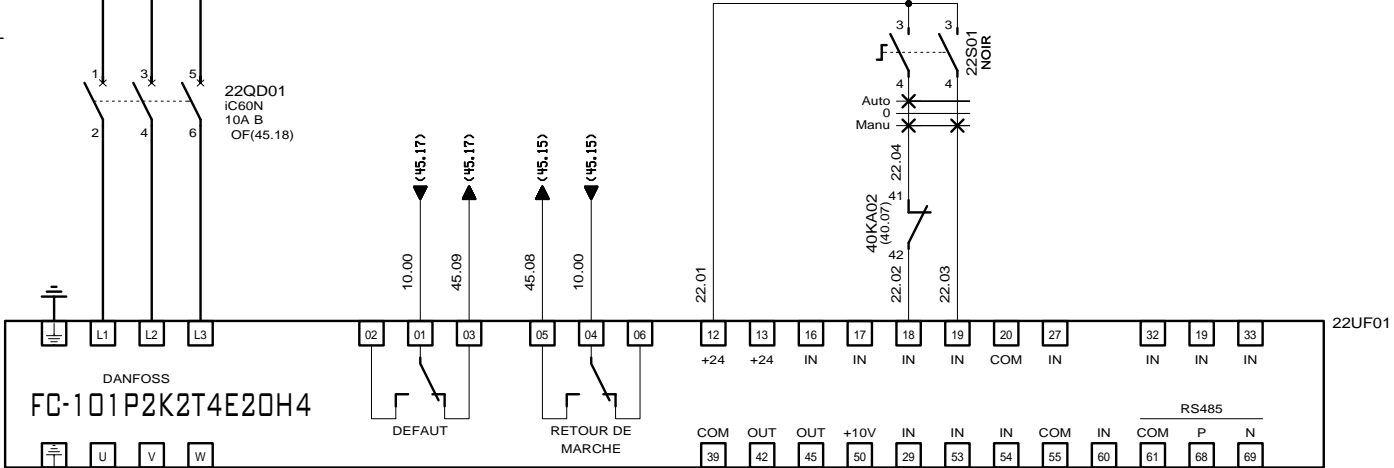
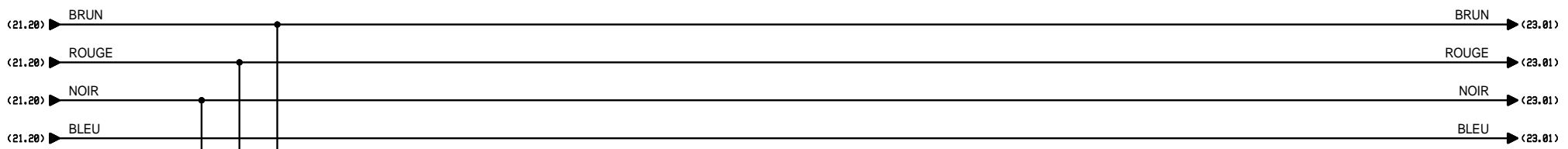

PARAMETRES
 Borne 18 = 8 (démarrage)
 Borne 19 = 16 (référence prédéfinie bit 0)

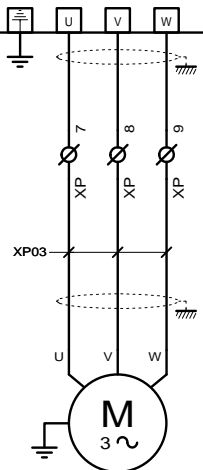

POMPE EFFETS D'EAU ZONE 3	
Pmax	2.2 kW
In	A

AUTOMATISMES SEGUIN
 Systeme Qualité
 3, Rue Pierre Curie
 91230 MONTGERON
 Tél. : 01.69.52.47.00 - Fax : 01.69.52.47.01
 e-mail : seguin@automatismes-seguin.fr
 http://www.automatismes-seguin.fr

PUISSANCE
POMPE EFFETS D'EAU ZONE 3

CLIENT ET NOM DU DOSSIER / CUSTOMER AND NAME OF FOLDER		INDICE / REVIEW
SEGEX ENERGIES Armoire Commande		A
DESSINATEUR DRAWER	C.C.	FOLIO/SHEET 22 / 23
N° AFFAIRE N° PROJECT	170200.1	
		IGE XAO VARI SERVICE PACK 7A

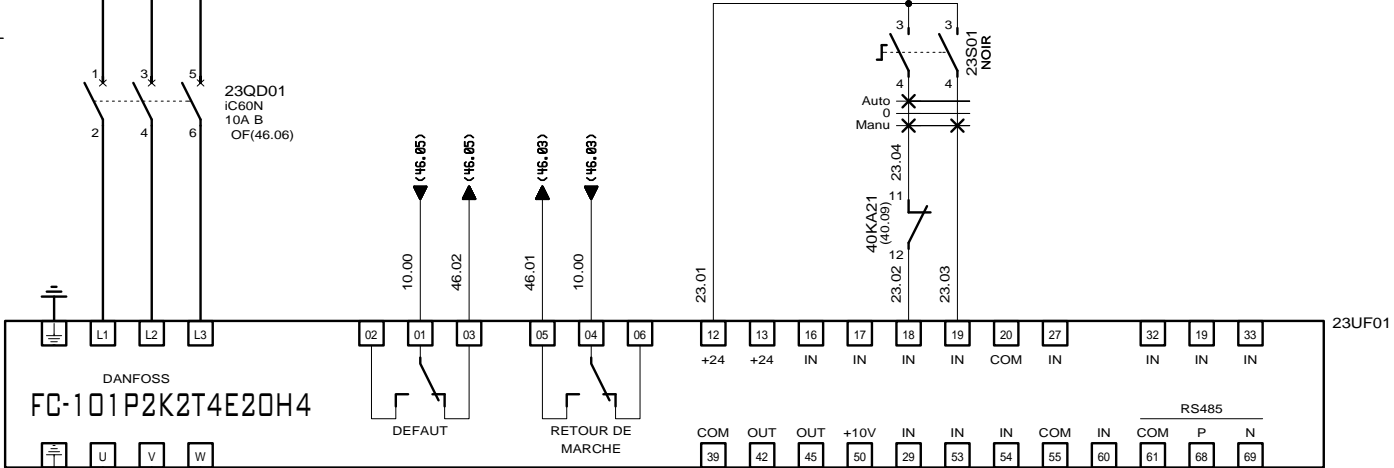
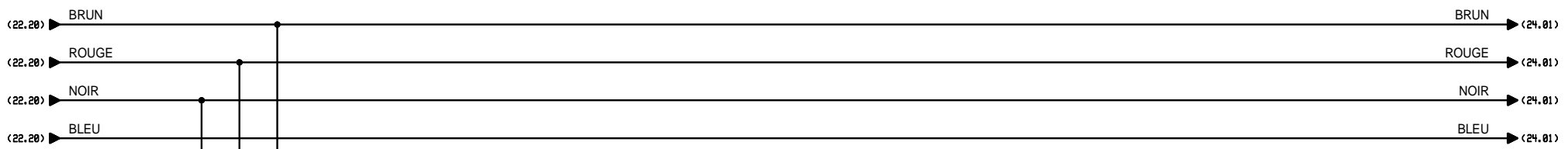

PARAMETRES
 Borne 18 = 8 (démarrage)
 Borne 19 = 16 (référence prédéfinie bit 0)

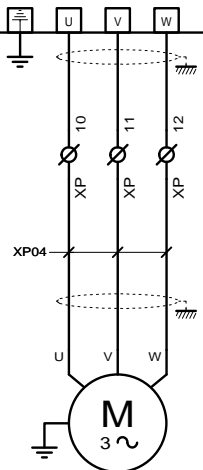

POMPE EFFETS D'EAU ZONE 4	
Pmax	2.2 kW
In	A

AUTOMATISMES SEGUIN
 Systeme Qualité
 3, Rue Pierre Curie
 91230 MONTGERON
 Tél. : 01.69.52.47.00 - Fax : 01.69.52.47.01
 e-mail : seguin@automatismes-seguin.fr
 http://www.automatismes-seguin.fr

PUISSANCE
POMPE EFFETS D'EAU ZONE 4

CLIENT ET NOM DU DOSSIER / CUSTOMER AND NAME OF FOLDER		INDICE / REVIEW
SEGEX ENERGIES Armoire Commande		A
DESSINATEUR DRAWER	C.C.	FOLIO/SHEET 23 / 24
N° AFFAIRE N° PROJECT	170200.1	
		IGE XAO VARI SERVICE PACK 7A

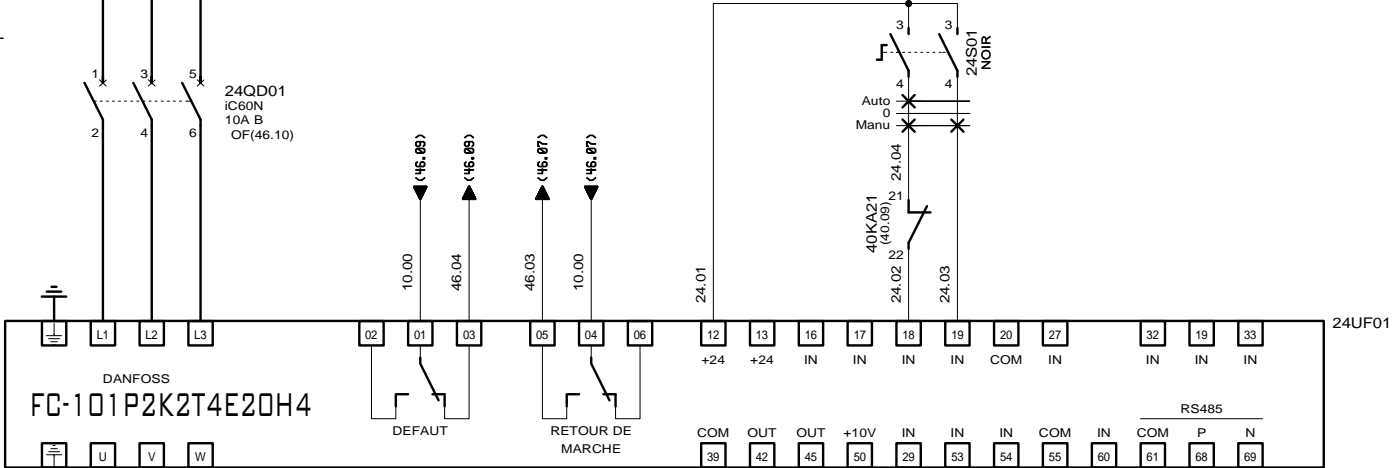
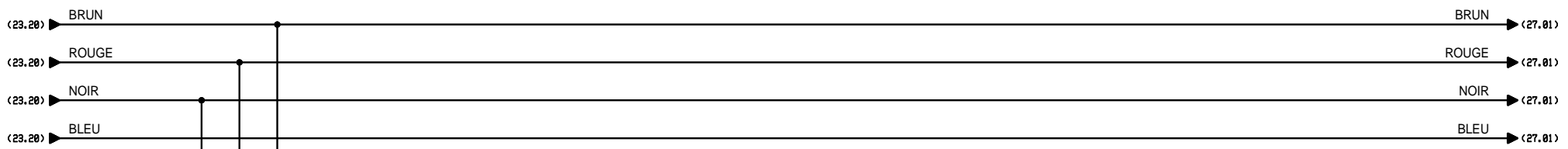

PARAMETRES
 Borne 18 = 8 (démarrage)
 Borne 19 = 16 (référence prédéfinie bit 0)

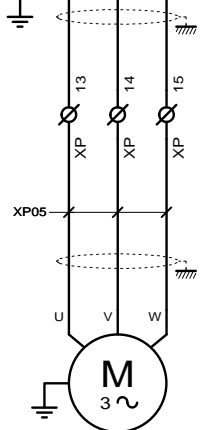

POMPE EFFETS D'EAU ZONE 5	
Pmax	2.2 kW
In	A

AUTOMATISMES SEGUIN
 Systeme Qualité
 3, Rue Pierre Curie
 91230 MONTGERON
 Tél. : 01.69.52.47.00 - Fax : 01.69.52.47.01
 e-mail : seguin@automatismes-seguin.fr
 http://www.automatismes-seguin.fr

PUISSANCE
POMPE EFFETS D'EAU ZONE 5

CLIENT ET NOM DU DOSSIER / CUSTOMER AND NAME OF FOLDER			INDICE / REVIEW
SEGEX ENERGIES			A
Armoire Commande			
DESSINATEUR / DRAWER	C.C.	FOLIO/SHEET	24 / 27
N° AFFAIRE / N° PROJECT	170200.1		



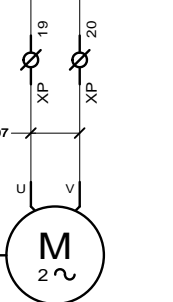
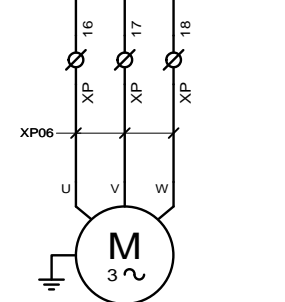
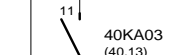
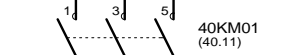
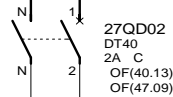
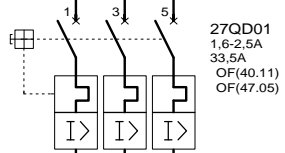
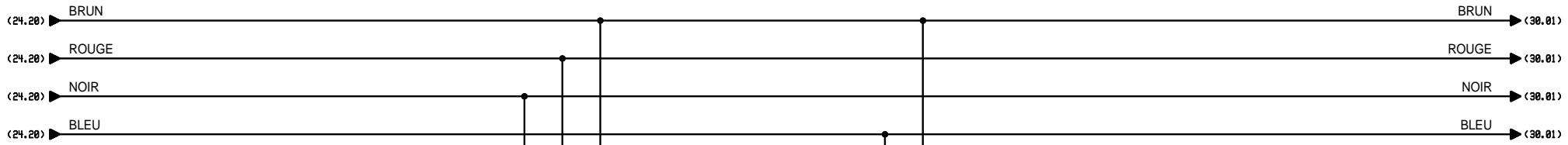

POMPE FILTRATION	
Pmax	1 kW
In	A

POMPE DOSEUSE	
Pmax	0.3 W
In	A

PUISSANCE

AUTOMATISMES SEGUIN
 Systeme Qualité
 3, Rue Pierre Curie
 91230 MONTGERON
 Tél. : 01.69.52.47.00 - Fax : 01.69.52.47.01
 e-mail : seguin@automatismes-seguin.fr
 http://www.automatismes-seguin.fr

CLIENT ET NOM DU DOSSIER / CUSTOMER AND NAME OF FOLDER		INDICE / REVIEW
SEGEX ENERGIES		A
Armoire Commande		
DESSINATEUR / DRAWER	C.C.	FOLIO/SHEET 27 / 30
N° AFFAIRE / N° PROJECT	170200.1	
		IGE XAO <small>VARI SERVICE PACK 7A</small>

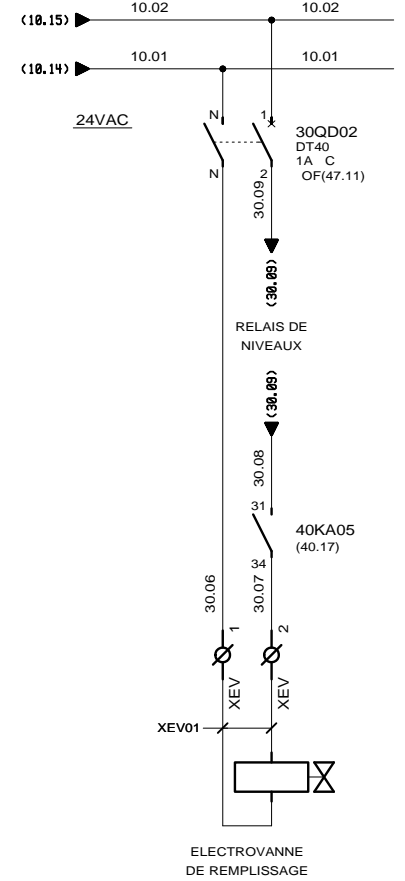
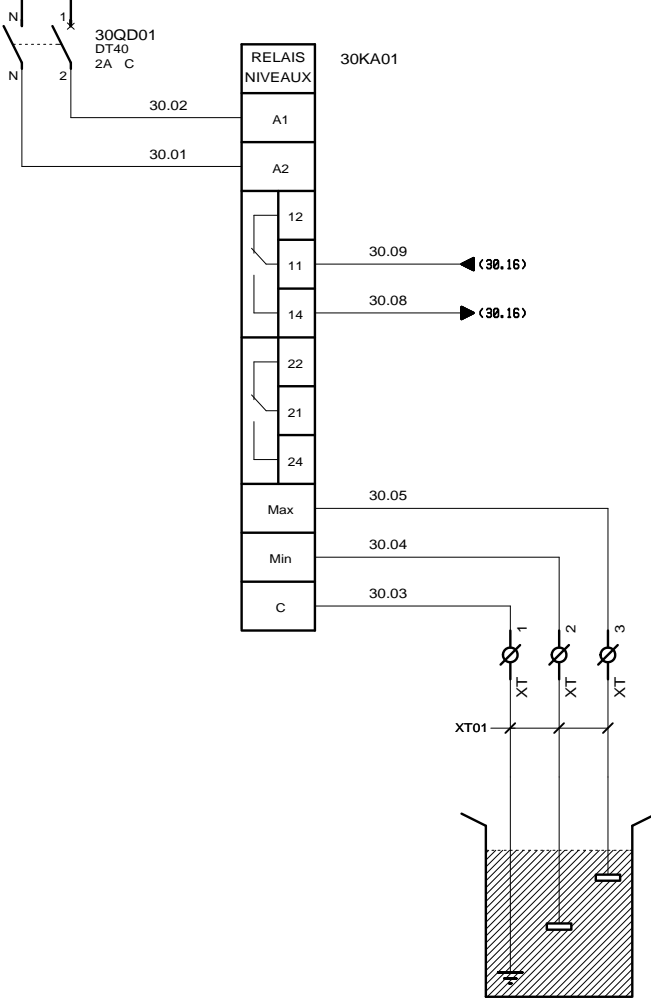
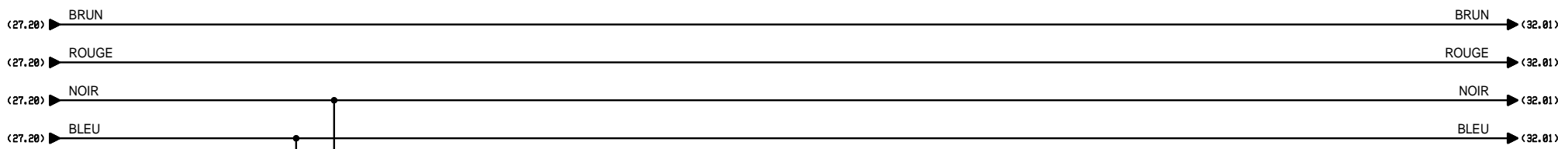

 3, Rue Pierre Curie
 91230 MONTGERON
 Tél. : 01.69.52.47.00 - Fax : 01.69.52.47.01
 e-mail : seguin@automatismes-seguin.fr
 http://www.automatismes-seguin.fr

MANQUE D'EAU

CLIENT ET NOM DU DOSSIER / CUSTOMER AND NAME OF FOLDER			INDICE / REVIEW
SEGEX ENERGIES			A
Armoire Commande			
DESSINATEUR DRAWER	C.C.	FOLIO/SHEET	30 / 32
N° AFFAIRE N° PROJECT	170200.1		
			IGE-XAO VARI SERVICE PACK 7A

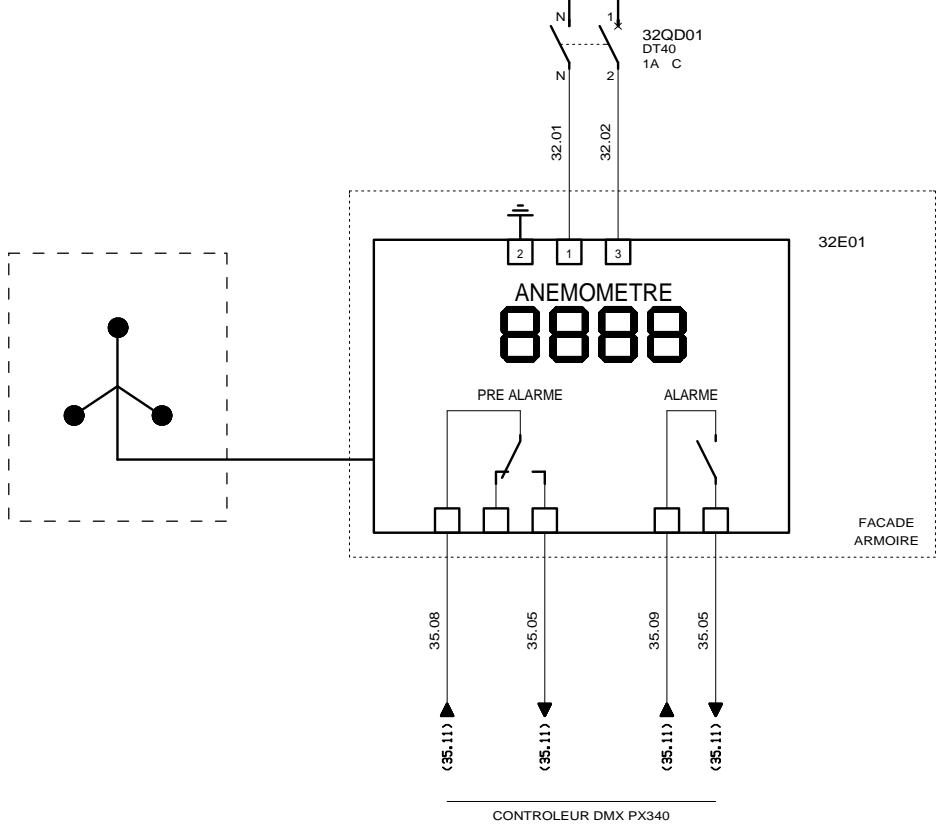



CONTROLEUR DMX PX340

AUTOMATISMES SEGUIN
 Systeme Qualité
 3, Rue Pierre Curie
 91230 MONTGERON
 Tél. : 01.69.52.47.00 - Fax : 01.69.52.47.01
 e-mail : seguin@automatismes-seguin.fr
 http://www.automatismes-seguin.fr

ANEMOMETRE

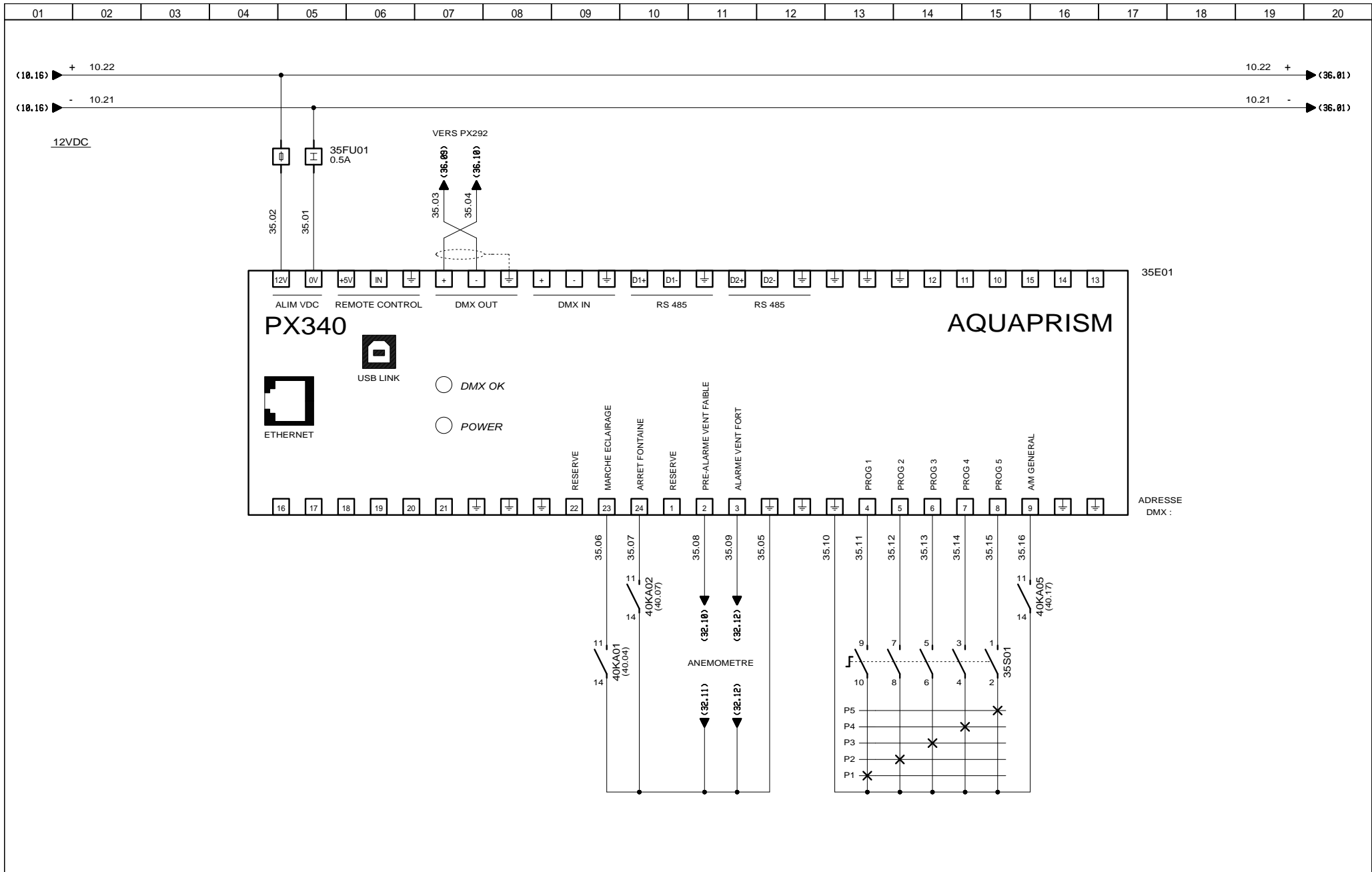
CLIENT ET NOM DU DOSSIER / CUSTOMER AND NAME OF FOLDER		INDICE / REVIEW
SEGEX ENERGIES Armoire Commande		A
DESSINATEUR DRAWER	C.C.	FOLIO/SHEET 32 / 35
N° AFFAIRE N° PROJECT	170200.1	
		IGE XAO VARI SERVICE PACK 7A





 3, Rue Pierre Curie
 91230 MONTGERON
 Tél. : 01.69.52.47.00 - Fax : 01.69.52.47.01
 e-mail : seguin@automatismes-seguin.fr
 http://www.automatismes-seguin.fr

CONTROLEUR DMX PX340

CLIENT ET NOM DU DOSSIER / CUSTOMER AND NAME OF FOLDER		INDICE / REVIEW
SEGEX ENERGIES Armoire Commande		A
DESSINATEUR DRAWER	C.C.	FOLIO/SHEET 35 / 36
N° AFFAIRE N° PROJECT	170200.1	
		VARI SERVICE PACK 7A

(35.20) + 10.22 10.22 +
 (35.20) - 10.21 10.21 -

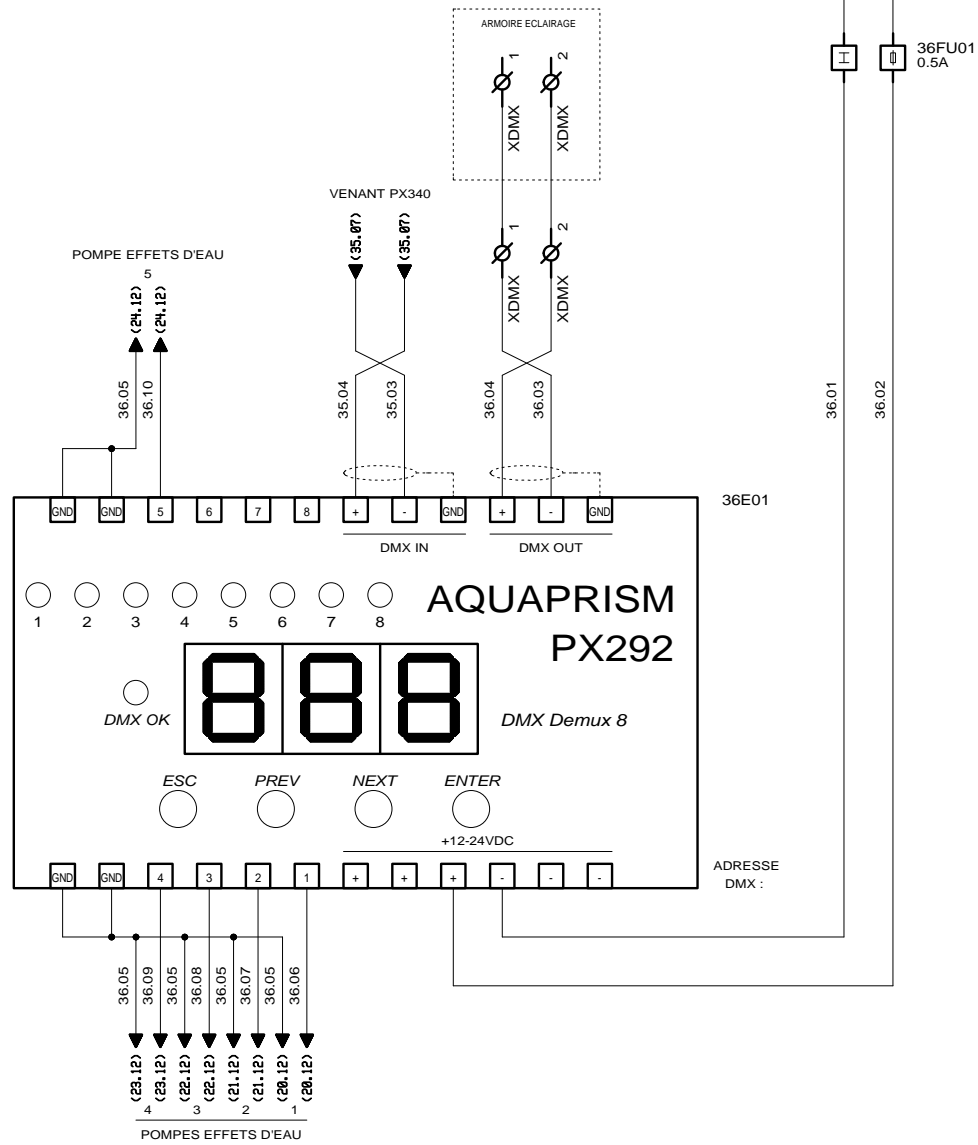
12VDC



AUTOMATISMES SEGUIN
 Systeme Qualité
 3, Rue Pierre Curie
 91230 MONTGERON
 Tél. : 01.69.52.47.00 - Fax : 01.69.52.47.01
 e-mail : seguin@automatismes-seguin.fr
 http://www.automatismes-seguin.fr

**INTERFACE DE SORTIE 4-20mA
 PX292**

CLIENT ET NOM DU DOSSIER / CUSTOMER AND NAME OF FOLDER			INDICE / REVIEW
SEGEX ENERGIES Armoire Commande			A
DESSINATEUR / DRAWER	C.C.	FOLIO/SHEET	36 / 40
N° AFFAIRE / N° PROJECT	170200.1	IGE XAO VARI SERVICE PACK 7A	

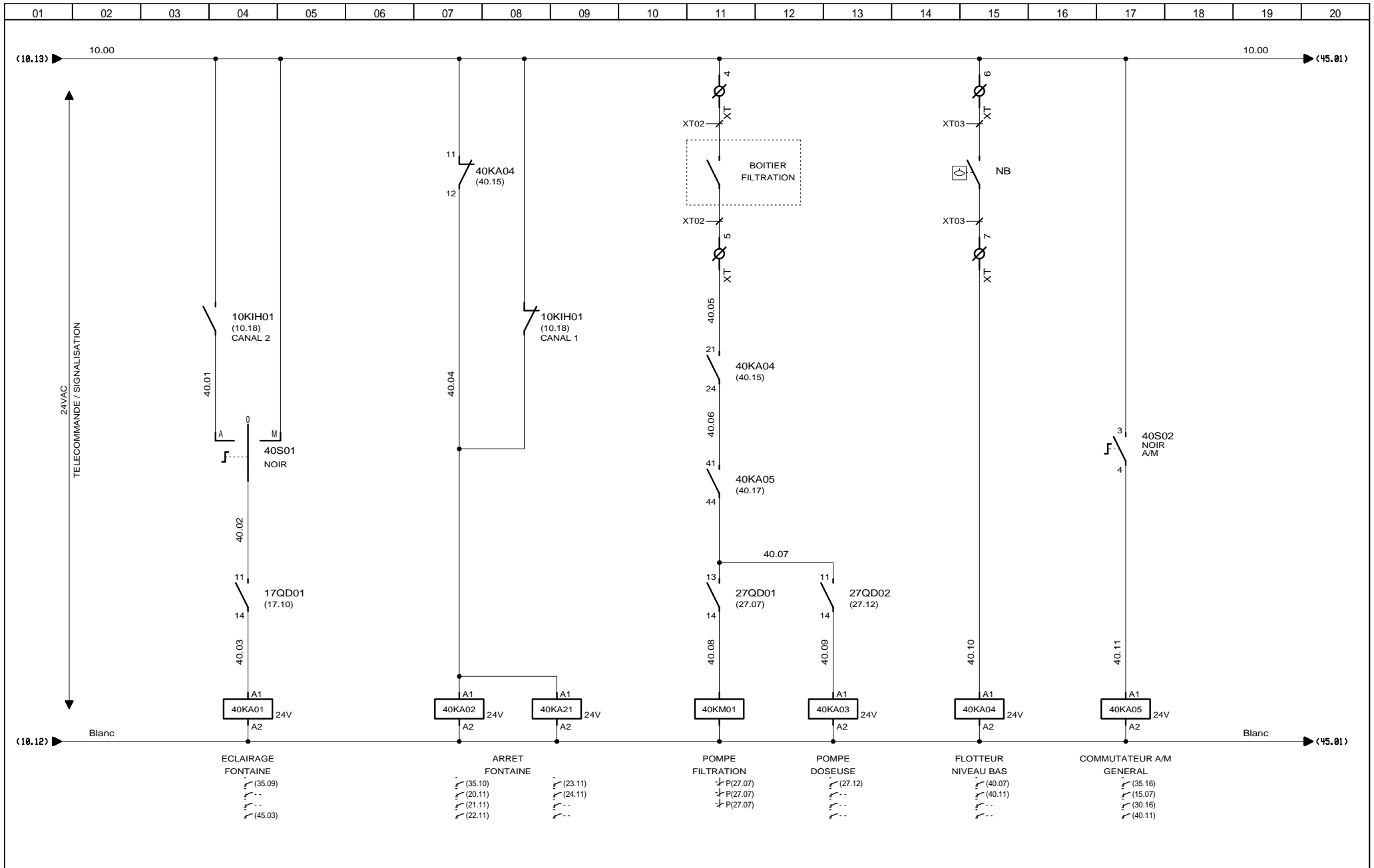

3, Rue Pierre Curie
91230 MONTGERON
Tél. : 01.69.52.47.00 - Fax : 01.69.52.47.01
e-mail : seguin@automatismes-seguin.fr
http://www.automatismes-seguin.fr

TELECOMMANDE

CLIENT ET NOM DU DOSSIER / CUSTOMER AND NAME OF FOLDER		INDICE / REVIEW
SEGEX ENERGIES		A
Armoire Commande		IGE XAO
DESSINATEUR DRAWER	C.C.	FOLIO/SHEET 40 / 45
N° AFFAIRE N° PROJECT	170200.1	VARI SERVICE PACK 7A

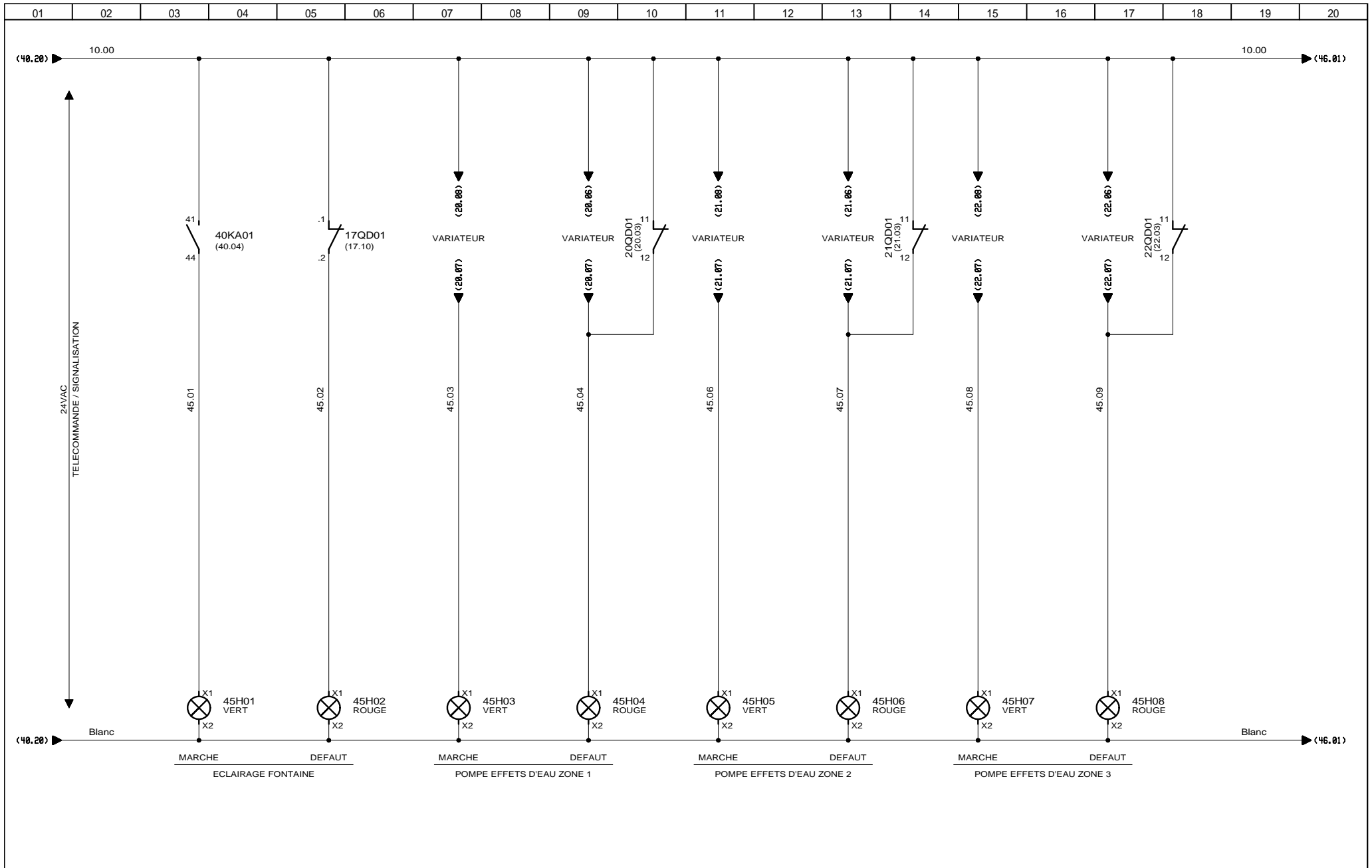

3, Rue Pierre Curie
91230 MONTGERON
Tél. : 01.69.52.47.00 - Fax : 01.69.52.47.01
e-mail : seguin@automatismes-seguin.fr
http://www.automatismes-seguin.fr

SIGNALISATION

CLIENT ET NOM DU DOSSIER / CUSTOMER AND NAME OF FOLDER		INDICE / REVIEW
SEGEX ENERGIES Armoire Commande		A
DESSINATEUR DRAWER	C.C.	FOLIO/SHEET 45 / 46
N° AFFAIRE N° PROJECT	170200.1	
		IGE-XAO VARI SERVICE PACK 7A

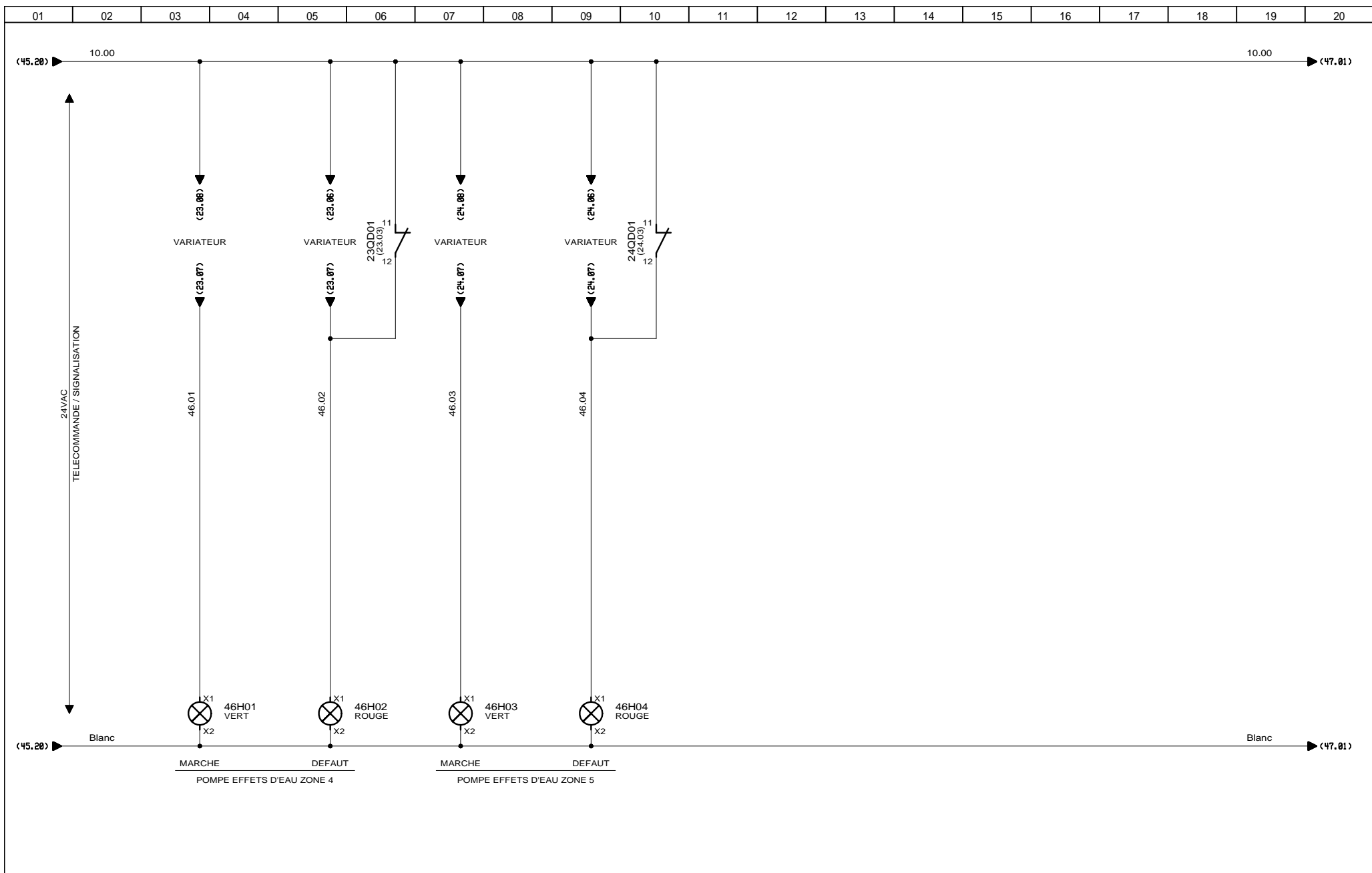

3, Rue Pierre Curie
91230 MONTGERON
Tél. : 01.69.52.47.00 - Fax : 01.69.52.47.01
e-mail : seguin@automatismes-seguin.fr
http://www.automatismes-seguin.fr

SIGNALISATION

CLIENT ET NOM DU DOSSIER / CUSTOMER AND NAME OF FOLDER		INDICE / REVIEW
SEGEX ENERGIES Armoire Commande		A
DESSINATEUR DRAWER	C.C.	FOLIO/SHEET 46 / 47
N° AFFAIRE N° PROJECT	170200.1	
		IGE XAO VARI SERVICE PACK 7A

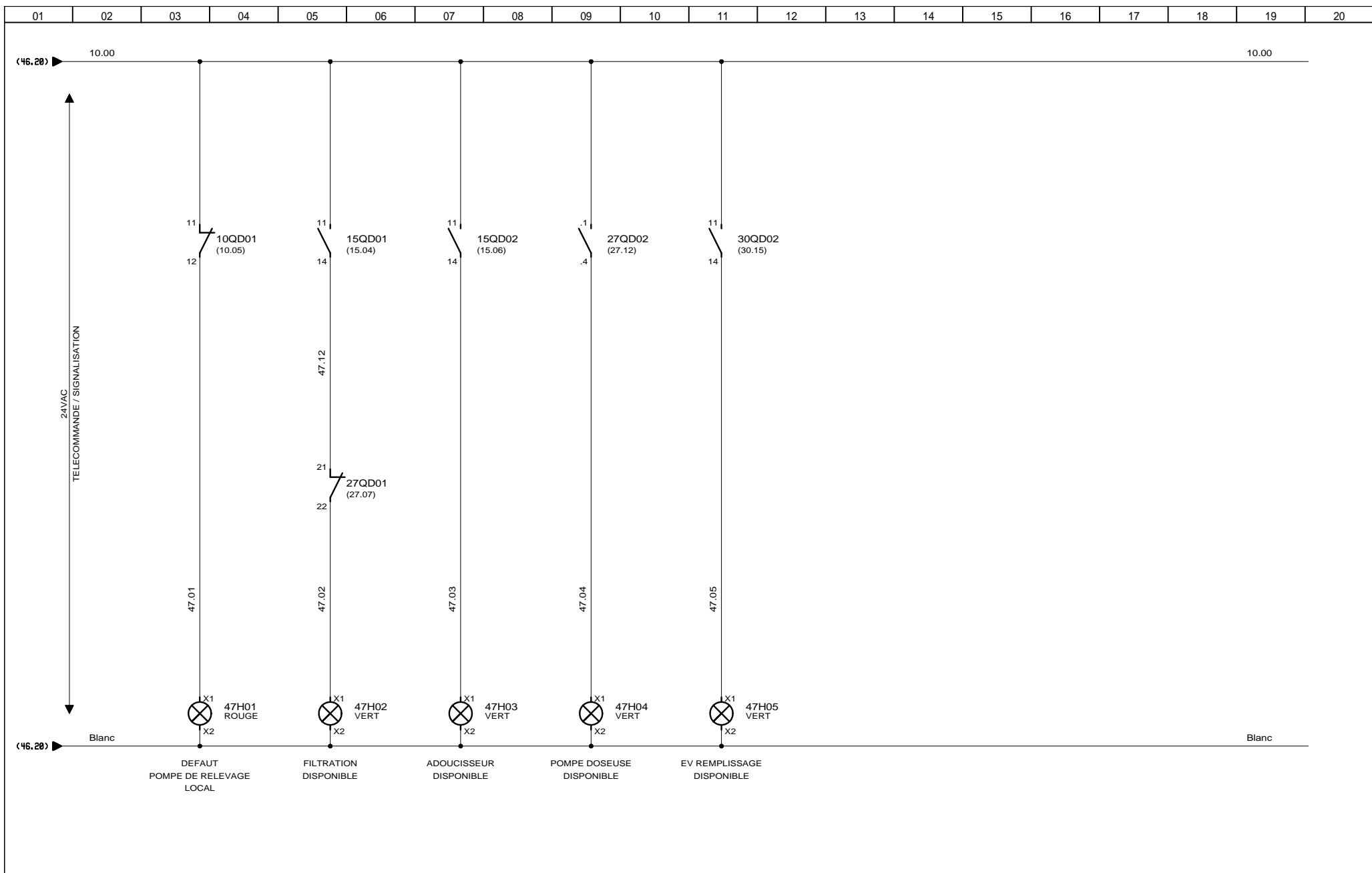

3, Rue Pierre Curie
 91230 MONTGERON
 Tél. : 01.69.52.47.00 - Fax : 01.69.52.47.01
 e-mail : seguin@automatismes-seguin.fr
 http://www.automatismes-seguin.fr

SIGNALISATION

CLIENT ET NOM DU DOSSIER / CUSTOMER AND NAME OF FOLDER		INDICE / REVIEW
SEGEX ENERGIES Armoire Commande		A
DESSINATEUR DRAWER	C.C.	FOLIO/SHEET 47 / 50
N° AFFAIRE N° PROJECT	170200.1	IGE-XAO VARI SERVICE PACK 7A

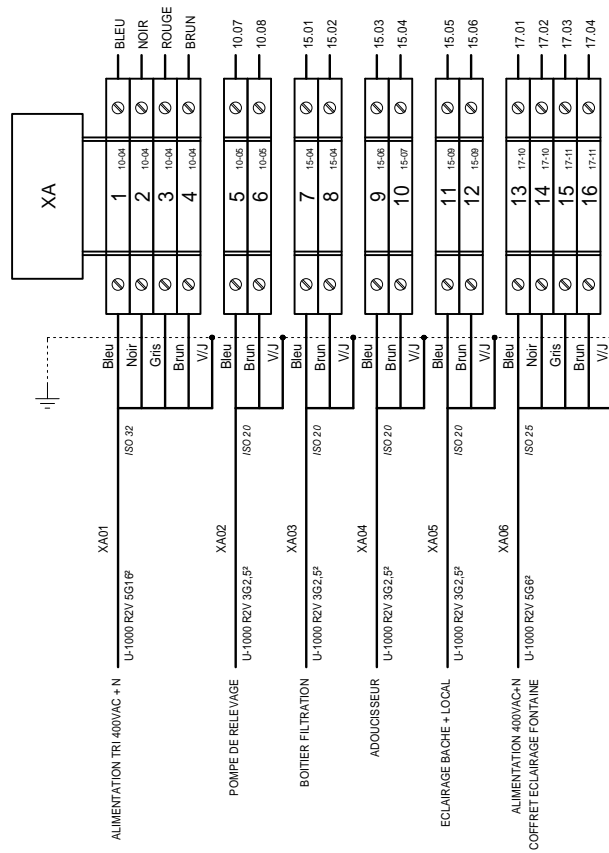

3, Rue Pierre Curie
91230 MONTGERON
Tél. : 01.69.52.47.00 - Fax : 01.69.52.47.01
e-mail : seguin@automatismes-seguin.fr
http://www.automatismes-seguin.fr

BORNIER XA ALIMENTATION

CLIENT ET NOM DU DOSSIER / CUSTOMER AND NAME OF FOLDER		INDICE / REVIEW
SEGEX ENERGIES Armoire Commande		A
DESSINATEUR DRAWER	C.C.	IGE XAO VARI SERVICE PACK 7A
N° AFFAIRE N° PROJECT	170200.1	
FOLIO/SHEET		50 / 51

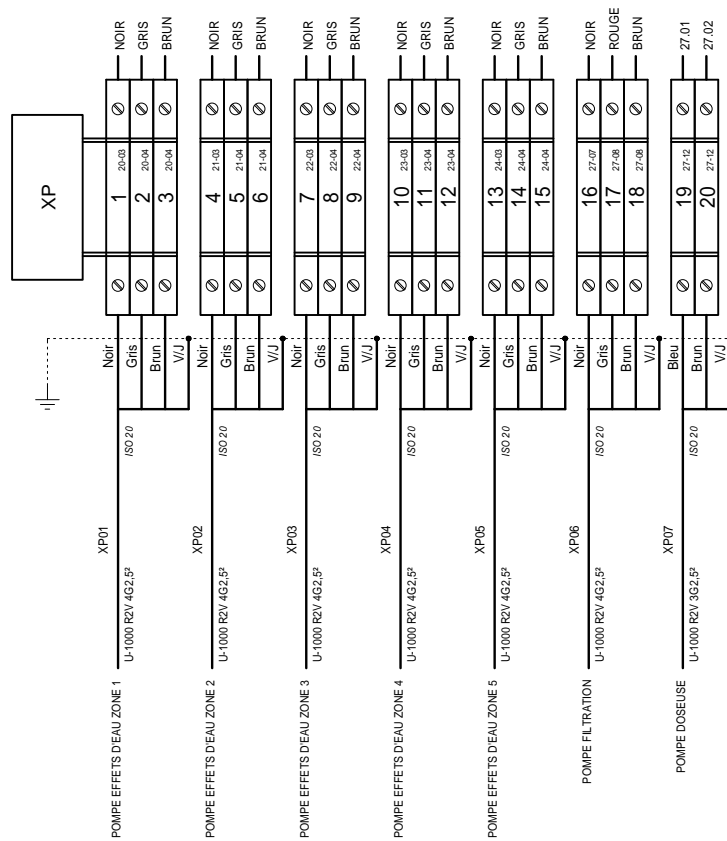

BORNIER XP PUISSANCE

CLIENT ET NOM DU DOSSIER / CUSTOMER AND NAME OF FOLDER		INDICE / REVIEW
SEGEX ENERGIES		A
Armoire Commande		
DESSINATEUR / DRAWER	C.C.	FOLIO/SHEET 51 / 52
N° AFFAIRE / N° PROJECT	170200.1	
		IGE XAO VAR1 SERVICE PACK 7A

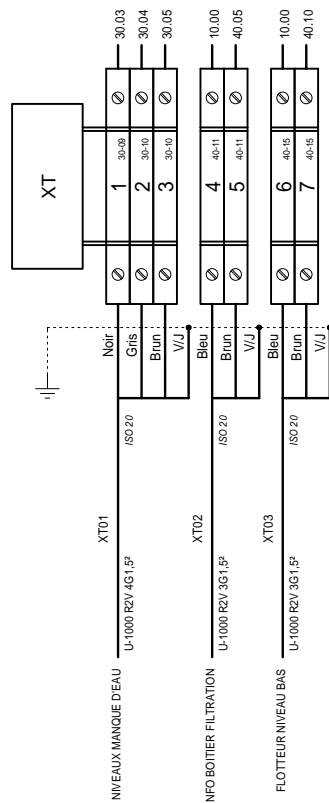

3, Rue Pierre Curie
91230 MONTGERON
Tél. : 01.69.52.47.00 - Fax : 01.69.52.47.01
e-mail : seguin@automatismes-seguin.fr
http://www.automatismes-seguin.fr

BORNIER XT TELECOMMANDE

CLIENT ET NOM DU DOSSIER / CUSTOMER AND NAME OF FOLDER		INDICE / REVIEW
SEGEX ENERGIES Armoire Commande		A
DESSINATEUR DRAWER	C.C.	FOLIO/SHEET 52 / 53
N° AFFAIRE N° PROJECT	170200.1	
		IGE XAO VARI SERVICE PACK 7A

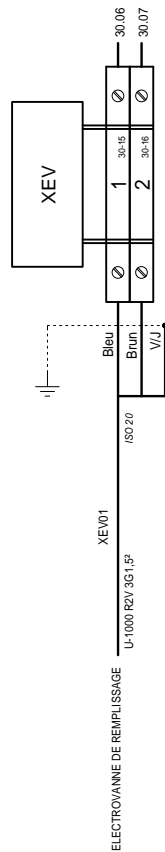

3, Rue Pierre Curie
91230 MONTGERON
Tél. : 01.69.52.47.00 - Fax : 01.69.52.47.01
e-mail : seguin@automatismes-seguin.fr
<http://www.automatismes-seguin.fr>

BORNIER XEV ELECTROVANNES

CLIENT ET NOM DU DOSSIER / CUSTOMER AND NAME OF FOLDER		INDICE / REVIEW
SEGEX ENERGIES Armoire Commande		A
DESSINATEUR DRAWER	C.C.	FOLIO/SHEET 53 / 54
N° AFFAIRE N° PROJECT	170200.1	
		IGE XAO VARI SERVICE PACK 7A

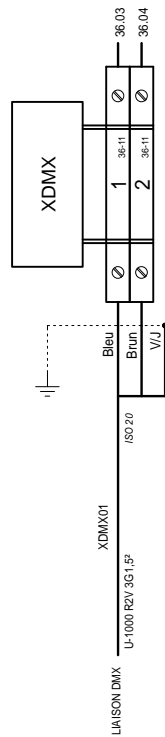

3, Rue Pierre Curie
 91230 MONTGERON
 Tél. : 01.69.52.47.00 - Fax : 01.69.52.47.01
 e-mail : seguin@automatismes-seguin.fr
 http://www.automatismes-seguin.fr

BORNIER XDMX LIAISON DMX

CLIENT ET NOM DU DOSSIER / CUSTOMER AND NAME OF FOLDER		INDICE / REVIEW
SEGEX ENERGIES Armoire Commande		A
DESSINATEUR DRAWER	C.C.	FOLIO/SHEET 54/60
N° AFFAIRE N° PROJECT	170200.1	
		IGE XAO VARI SERVICE PACK 7A

REPERE	DESIGNATION	REFERENCE	MARQUE	QTE
	TOLERIE			
	ARMOIRE EN ACIER MONOBLOC AVEC PORTE PLEINE SANS CHASSIS 1600x800x400	NSYSM16840	SCHNEIDER ELECTRIC	1
	POCHETTE OUVERTE POUR PLANS AUTOCOLLANTE, 340x235mm (ACC D'ENVELOPPES)	036580	LEGRAND	1
	TABLETTE DE PORTE 800mm, GRIS RAL7032	NSYSDT8	SCHNEIDER ELECTRIC	1
	JEU 2 JOINTS TECHN.L800 18500	NSYSMBCE8	SCHNEIDER ELECTRIC	1
	LOT DE 4 ANNEAUX DE LEVAGE M12	NSYSMEB	SCHNEIDER ELECTRIC	1
	SOCLE FRONTAL SF/SM 200x800	NSYSPF8200	SCHNEIDER ELECTRIC	1
	JEU DE 4 TRAPPES LATERALES POUR ARMOIRE P400	NSYSPS4200	SCHNEIDER ELECTRIC	1
	MANETTE DE CONDAMNATION, SERRURE CLE 1242E	NSYTHL1242EPLM	SCHNEIDER ELECTRIC	1
10E01	JEU DE 2 SUPPORTS TETRAPOLAIRES POUR BARRES 12x2 OU 12x4mm	037396	LEGRAND	1
10H01	VOYANT INCOLORE DEL 230V	XB7EV07MP	SCHNEIDER ELECTRIC	1
10KIH01	INTERRUPTEUR HORAIRE PROGRAMMABLE MULTIFONCTION DIGITAL LEXIC, 230VAC, 2 SORTIE 16A, 2 MODULES	412641	LEGRAND	1
10QD01	DISJONCTEUR DT40 1P+N 16A 6kA, COURBE C	A9N21025	SCHNEIDER ELECTRIC	1
	BLOC VIGI DT40 1P+N CLASSE AC 25A 30mA 230VAC	A9N21450	SCHNEIDER ELECTRIC	1
	CONTACT AUXILIAIRE OF	A9N26924	SCHNEIDER ELECTRIC	1
10QD02	DISJONCTEUR DT40 1P+N 1A 6kA, COURBE C	A9N21019	SCHNEIDER ELECTRIC	1
10QD03	DISJONCTEUR IC60N 2P 2A, 440VAC/25kA, 133VDC/6kA, COURBE C	A9F74202	SCHNEIDER ELECTRIC	1
10QD04	DISJONCTEUR DT40 1P+N 4A 6kA, COURBE C	A9N21022	SCHNEIDER ELECTRIC	1
10QD05	DISJONCTEUR DT40 1P+N 2A 6kA, COURBE C	A9N21020	SCHNEIDER ELECTRIC	1
10QD06	DISJONCTEUR DT40 1P+N 2A 6kA, COURBE C	A9N21020	SCHNEIDER ELECTRIC	1
10QD07	DISJONCTEUR C60H-DC 1A 2P, 500VDC, COURBE C	A9N61521	SCHNEIDER ELECTRIC	1
10QD08	DISJONCTEUR DT40 1P+N 2A 6kA, COURBE C	A9N21020	SCHNEIDER ELECTRIC	1
10QDG01	DISJONCTEUR IC60N 4P 63A, 440VAC/6kA, 250VDC/6kA, COURBE C	A9F77463	SCHNEIDER ELECTRIC	1
	DECLENCHEUR A EMISSION DE TENSION IMX+OF 100-415V 50-60Hz / 110-130VDC	A9A26946	SCHNEIDER ELECTRIC	1
	BLOC VIGI IC60AC 4P 63A, 240/415VAC	A9V14463	SCHNEIDER ELECTRIC	1
10S01	TETE ARRET D'URGENCE	ZB4BS844	SCHNEIDER ELECTRIC	1
	CORPS CONTACT NO	ZB4BZ101	SCHNEIDER ELECTRIC	1
10TR01	TRANSFORMATEUR DE COMMANDE ET DE SIGNALISATION MONOPHASEE 230-400V/24-48V, 100VA	044233	LEGRAND	1
10U01	ALIMENTATION MONOPHASEE 115-230VAC/12VDC, 15W, 1,25A	DR-15-12	MEAN WELL	1
12ECH01	RESISTANCE CHAUFFANTE PTC CS 060, 120-240V AC/DC, 50W	06000.0-00	STEGO	1
12ECL01	LAMPE RENTABLE 8W 220V 50-60Hz 400lm	NSYLAM8T5	SCHNEIDER ELECTRIC	1
12KTH01	PETIT THERMOSTAT KTO 011, 1NF, 0..60°C	01146.9-00	STEGO	1
12KTH02	PETIT THERMOSTAT KTS 011, 1NO, 0..60°C	01147.9-00	STEGO	1
12QD01	DISJONCTEUR DT40 1P+N 2A 6kA, COURBE C	A9N21020	SCHNEIDER ELECTRIC	1
12QD02	DISJONCTEUR DT40 1P+N 1A 6kA, COURBE C	A9N21019	SCHNEIDER ELECTRIC	1
12QD03	DISJONCTEUR DT40 1P+N 16A 6kA, COURBE C	A9N21025	SCHNEIDER ELECTRIC	1
	BLOC VIGI DT40 1P+N CLASSE AC 25A 30mA 230VAC	A9N21450	SCHNEIDER ELECTRIC	1
12S01	CONTACT DE PORTE POUR CELLULES SF NO+NF	NSYDCM20	SCHNEIDER ELECTRIC	1
12X01	PRISE DE COURANT 2P+T 10/16A, 250VAC A ECLIPS	004280	LEGRAND	1
15QD01	DISJONCTEUR DT40 1P+N 2A 6kA, COURBE C	A9N21020	SCHNEIDER ELECTRIC	1
	CONTACT AUXILIAIRE OF	A9N26924	SCHNEIDER ELECTRIC	1
15QD02	DISJONCTEUR DT40 1P+N 2A 6kA, COURBE C	A9N21020	SCHNEIDER ELECTRIC	1
	CONTACT AUXILIAIRE OF	A9N26924	SCHNEIDER ELECTRIC	1
15QD03	DISJONCTEUR DT40 1P+N 16A 6kA, COURBE C	A9N21025	SCHNEIDER ELECTRIC	1
17QD01	DISJONCTEUR IC60N 4P 25A, 440VAC/6kA, 250VDC/6kA, COURBE C	A9F77425	SCHNEIDER ELECTRIC	1
	CONTACT AUXILIAIRE IOF+SD/OF	A9A26929	SCHNEIDER ELECTRIC	1
20QD01	DISJONCTEUR IC60N 2P 10A, 440VAC/6kA, 133VDC/6kA, COURBE B	A9F76210	SCHNEIDER ELECTRIC	1
	CONTACT AUXILIAIRE IOF	A9A26924	SCHNEIDER ELECTRIC	1



3, Rue Pierre Curie
91230 MONTGERON
Tél. : 01.69.52.47.00 - Fax : 01.69.52.47.01
e-mail : seguin@automatismes-seguin.fr
http://www.automatismes-seguin.fr

NOMENCLATURE

CLIENT ET NOM DU DOSSIER / CUSTOMER AND NAME OF FOLDER			INDICE / REVIEW
SEGEX ENERGIES			A
Armoire Commande			
DESSINATEUR DRAWER	C.C.	FOLIO/SHEET	60 / 61
N° AFFAIRE N° PROJECT	170200.1		
			IGEXAO VARI SERVICE PACK 7A

REPERE	DESIGNATION	REFERENCE	MARQUE	QTE
20S01	TETE BOUTON TOURNANT 3 POSITIONS	ZB4BD3	SCHNEIDER ELECTRIC	1
	CORPS CONTACT 2NO	ZB4BZ103	SCHNEIDER ELECTRIC	1
	CONTACT VIS ETRIER 1NO	ZBE101	SCHNEIDER ELECTRIC	1
20UF01	CONVERTISSEUR DE FREQUENCE FC-101 2.2kW 3x380/500VAC, IP20	FC-101P2K2T4E20H4	DANFOSS	1
21QD01	DISJONCTEUR IC60N 2P 10A, 440VAC/6kA, 133VDC/6kA, COURBE B	A9F76210	SCHNEIDER ELECTRIC	1
	CONTACT AUXILIAIRE IOF	A9A26924	SCHNEIDER ELECTRIC	1
21S01	TETE BOUTON TOURNANT 3 POSITIONS	ZB4BD3	SCHNEIDER ELECTRIC	1
	CORPS CONTACT 2NO	ZB4BZ103	SCHNEIDER ELECTRIC	1
	CONTACT VIS ETRIER 1NO	ZBE101	SCHNEIDER ELECTRIC	1
21UF01	CONVERTISSEUR DE FREQUENCE FC-101 2.2kW 3x380/500VAC, IP20	FC-101P2K2T4E20H4	DANFOSS	1
22QD01	DISJONCTEUR IC60N 2P 10A, 440VAC/6kA, 133VDC/6kA, COURBE B	A9F76210	SCHNEIDER ELECTRIC	1
	CONTACT AUXILIAIRE IOF	A9A26924	SCHNEIDER ELECTRIC	1
22S01	TETE BOUTON TOURNANT 3 POSITIONS	ZB4BD3	SCHNEIDER ELECTRIC	1
	CORPS CONTACT 2NO	ZB4BZ103	SCHNEIDER ELECTRIC	1
	CONTACT VIS ETRIER 1NO	ZBE101	SCHNEIDER ELECTRIC	1
22UF01	CONVERTISSEUR DE FREQUENCE FC-101 2.2kW 3x380/500VAC, IP20	FC-101P2K2T4E20H4	DANFOSS	1
23QD01	DISJONCTEUR IC60N 2P 10A, 440VAC/6kA, 133VDC/6kA, COURBE B	A9F76210	SCHNEIDER ELECTRIC	1
	CONTACT AUXILIAIRE IOF	A9A26924	SCHNEIDER ELECTRIC	1
23S01	TETE BOUTON TOURNANT 3 POSITIONS	ZB4BD3	SCHNEIDER ELECTRIC	1
	CORPS CONTACT 2NO	ZB4BZ103	SCHNEIDER ELECTRIC	1
	CONTACT VIS ETRIER 1NO	ZBE101	SCHNEIDER ELECTRIC	1
23UF01	CONVERTISSEUR DE FREQUENCE FC-101 2.2kW 3x380/500VAC, IP20	FC-101P2K2T4E20H4	DANFOSS	1
24QD01	DISJONCTEUR IC60N 2P 10A, 440VAC/6kA, 133VDC/6kA, COURBE B	A9F76210	SCHNEIDER ELECTRIC	1
	CONTACT AUXILIAIRE IOF	A9A26924	SCHNEIDER ELECTRIC	1
24S01	TETE BOUTON TOURNANT 3 POSITIONS	ZB4BD3	SCHNEIDER ELECTRIC	1
	CORPS CONTACT 2NO	ZB4BZ103	SCHNEIDER ELECTRIC	1
	CONTACT VIS ETRIER 1NO	ZBE101	SCHNEIDER ELECTRIC	1
24UF01	CONVERTISSEUR DE FREQUENCE FC-101 2.2kW 3x380/500VAC, IP20	FC-101P2K2T4E20H4	DANFOSS	1
27QD01	DISJONCTEUR MOTEUR MAGNETO-THERMIQUE 1.6-2.5A, BORNES A VIS	GV2ME07	SCHNEIDER ELECTRIC	1
	ADDITIF FRONTAL F+O	GVAE11	SCHNEIDER ELECTRIC	1
27QD02	DISJONCTEUR DT40 1P+N 2A 6kA, COURBE C	A9N21020	SCHNEIDER ELECTRIC	1
	CONTACT OF + SD/OF 3A SOUS 415VAC/6A SOUS 240V AC	A9N26929	SCHNEIDER ELECTRIC	1
30KA01	RELAIS DE CONTROLE DE NIVEAU, 2INV, ALIM. 24/230V AC/DC	RM35LM33MW	SCHNEIDER ELECTRIC	1
30QD01	DISJONCTEUR DT40 1P+N 2A 6kA, COURBE C	A9N21020	SCHNEIDER ELECTRIC	1
30QD02	DISJONCTEUR DT40 1P+N 1A 6kA, COURBE C	A9N21019	SCHNEIDER ELECTRIC	1
	CONTACT AUXILIAIRE IOF	A9N26924	SCHNEIDER ELECTRIC	1
32QD01	DISJONCTEUR DT40 1P+N 1A 6kA, COURBE C	A9N21019	SCHNEIDER ELECTRIC	1
35E01	CONTROLEUR DMX 12VDC 400mA MAXI	PX340	AQUAPRISM	1
35S01	COMMUTEUR DIA. 22	K1E005NCH	SCHNEIDER ELECTRIC	1
36E01	INTERFACE DMX AVEC SORTIES 4-20mA	PX292	AQUAPRISM	1
40KA01	RELAIS INDUSTRIEL EMBROCHABLE, MONOSTABLE, 4INV, 24VAC + EMBASE	RMIA4524AC + ZMI4SA	CARLO GAVAZZI	1
40KA02	RELAIS INDUSTRIEL EMBROCHABLE, MONOSTABLE, 4INV, 24VAC + EMBASE	RMIA4524AC + ZMI4SA	CARLO GAVAZZI	1
40KA03	RELAIS INDUSTRIEL EMBROCHABLE, MONOSTABLE, 4INV, 24VAC + EMBASE	RMIA4524AC + ZMI4SA	CARLO GAVAZZI	1
40KA04	RELAIS INDUSTRIEL EMBROCHABLE, MONOSTABLE, 4INV, 24VAC + EMBASE	RMIA4524AC + ZMI4SA	CARLO GAVAZZI	1
40KA05	RELAIS INDUSTRIEL EMBROCHABLE, MONOSTABLE, 4INV, 24VAC + EMBASE	RMIA4524AC + ZMI4SA	CARLO GAVAZZI	1
40KA21	RELAIS INDUSTRIEL EMBROCHABLE, MONOSTABLE, 4INV, 24VAC + EMBASE	RMIA4524AC + ZMI4SA	CARLO GAVAZZI	1
40S01	TETE BOUTON TOURNANT 3 POSITIONS	ZB4BD3	SCHNEIDER ELECTRIC	1



3, Rue Pierre Curie
91230 MONTGERON
Tél. : 01.69.52.47.00 - Fax : 01.69.52.47.01
e-mail : seguin@automatismes-seguin.fr
http://www.automatismes-seguin.fr

NOMENCLATURE

CLIENT ET NOM DU DOSSIER / CUSTOMER AND NAME OF FOLDER		INDICE / REVIEW
SEGEX ENERGIES		A
Armoire Commande		
DESSINATEUR DRAWER	C.C.	FOLIO/SHEET 61 / 62
N° AFFAIRE N° PROJECT	170200.1	
		IGE XAO VARI SERVICE PACK 7A

